

User manual

Cooker

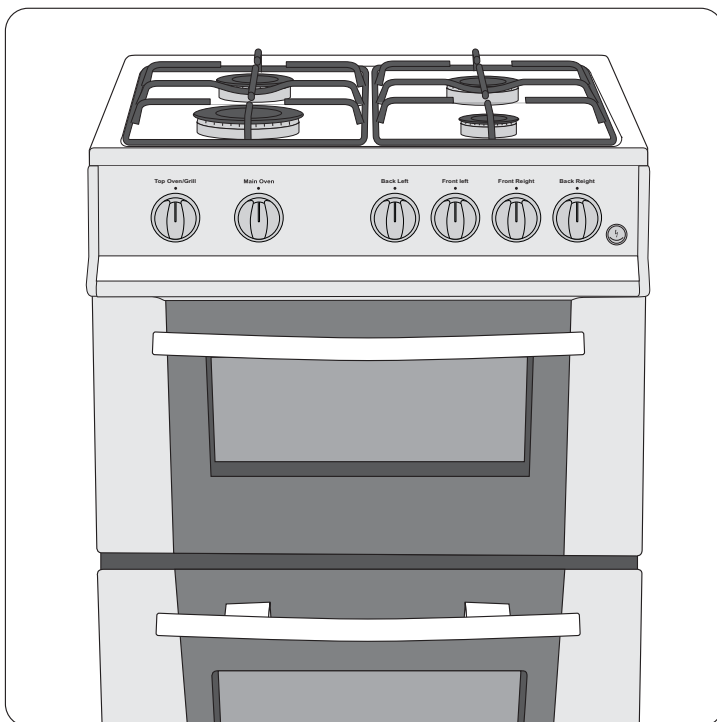

ZKG5020

## Thank you for selecting our appliance

We wish you lots of enjoyment with your new appliance and we hope that you will consider our brand again when purchasing household appliances.

Please read this user manual carefully and keep it throughout the product life cycle as a reference document. The user manual should be passed on to any future owner of the appliance.

## Contents

---

Safety instructions _____	3	Cooking tables _____	17
Description of the appliance _____	5	Care and cleaning _____	19
Before first use _____	7	What to do if... _____	22
Grill and oven furniture _____	8	Technical Data _____	24
The hob _____	9	Installation _____	25
The grill _____	11	Environmental Information _____	31
The main oven _____	14	Guarantee/Customer Service _____	31

Subject to change without notice

## Safety instructions

---

### General safety

These warnings are provided in the interest of your safety. Ensure that you understand them all before installing or using the appliance. Your safety is of paramount importance. If you are unsure about any of the meanings of these warnings please contact customer care.

### Installation

- The appliance must be installed according to the instructions supplied.
- The installation work must be undertaken by a qualified electrician or competent person as stated in the Gas Safety (Installation & Use) Regulations current editions and the IEE Wiring Regulations.
- For appliances installed in the Republic of Ireland please refer to NSAI - Domestic Gas installation IS813 Current Editions.
- The appliance should be serviced by an authorised Service Engineer and only genuine approved spare parts should be used.
- It is important that the appliance is suitable for your gas supply. Your installer should check the rating plate.
- Make sure that a stability chain is fitted.
- The appliance must be installed in an adequately ventilated room.
- If the appliance is to be placed on a base, measures must be taken to prevent the appliance from slipping.
- This appliance is heavy and care must be taken when moving it.
- Do not attempt to lift or move this appliance by the handles.

- All packaging, both inside and outside the appliance must be removed before the appliance is used.
- It is dangerous to alter the specifications or modify the appliance in any way.

### Child safety

- Do not allow children to play with any part of the packaging.
- Do not allow children to sit or climb on the drop down doors.
- This appliance is not intended for use by children and other persons whose physical, sensory or mental capabilities or lack of experience and knowledge prevents them from using the appliance safely without supervision or instruction by a responsible person to ensure that they can use the appliance safely.
- Children should be supervised to ensure that they do not play with the appliance.

#### **WARNING!**

Accessible parts may be hot during use. Young children should be kept away.

### During use

- This appliance is not intended to be operated by means of an external timer or separate remote control system.
- This appliance has been designed for domestic use to cook edible foodstuffs only and must not be used for any other purposes.
- Take great care when heating fats and oils, as they will ignite if they become too hot.

- When you are lighting any burner check that it is lit before you leave the appliance. When turning off a burner, do not leave the appliance until the flame has gone out.
- Never place plastic or any other material, which may melt in or on the oven.
- Do not leave the grill pan handle in position when grilling, as it will become hot.
- Always support the grill pan when it is in the withdrawn or partially withdrawn position.
- Always use oven gloves to remove and replace the grill pan handle when grilling.
- Always use oven gloves to remove and place food in the oven.
- Ensure cooking utensils are large enough to contain foods to prevent spillage and boil over.
- The handles of saucepans, which are smaller than the heated area on the hob, will become hot.
- Ensure your hand is protected before handling the pan.
- During use the appliance becomes hot. Care should be taken to avoid touching heating elements inside the oven.
- Ensure that all vents are not obstructed to ensure ventilation of the oven cavity.
- Never line any part of the appliance with foil.
- Always stand back from the appliance when opening the doors to allow any build up of steam or heat to release.

 **WARNING!**

Never leave the appliance unattended when the oven door is open.

- Do not place sealed cans or aerosols inside the oven. They may explode if they are heated.

- Ensure that all control knobs are in the off position when not in use.
- Do not stand on the appliance or on the open oven doors.
- Do not hang towels, dishcloths or clothes from the appliance or its handles.
- Do not use this appliance if it is in contact with water.
- Never operate it with wet hands.

## Cleaning and maintenance

 **WARNING!**

For hygiene and safety reasons this appliance should be kept clean at all times. A build-up of fat or other foodstuff could result in a fire especially in the grill pan.

- Do not leave the cookware containing foodstuff, e.g. fat or oil in the appliance in case it is inadvertently switched on.
- Do not disconnect the appliance from the gas supply if the supply pipe does not have a bayonet connection as described in the installation section. If this is the case contact the person who installed the appliance.
- Always allow the appliance to cool before switching off before carrying out any cleaning/maintenance work.
- Only clean this appliance in accordance with the instructions given in this book.
- Never use steam or high-pressure steam cleaners to clean the appliance.
- Do not use harsh abrasive cleaners or sharp metal scraper to clean the oven door glass since they can scratch the surface, which may result in shattering of the glass.

## Description of the appliance

---

### Product description

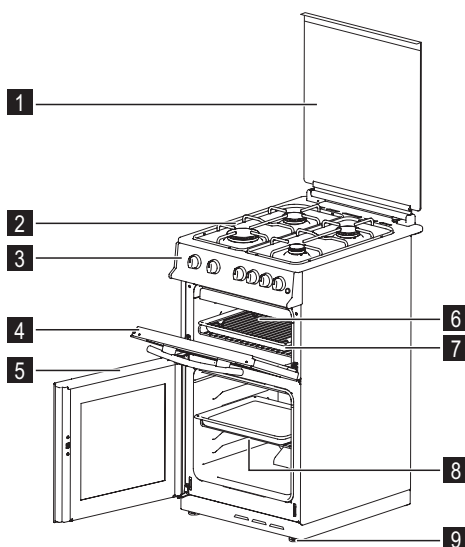

- 1** Glass Hob Lid
- 2** Pan Supports
- 3** Control Panel
- 4** Grill Door
- 5** Main Oven Door
- 6** Grill Pan Grid
- 7** Grill Pan
- 8** Shelf
- 9** Levelling Feet

## Controls and their functions

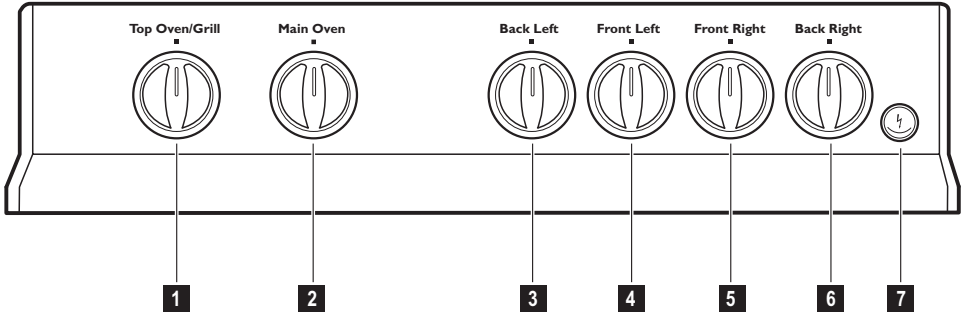

- 1** Top Oven/Grill Knob
- 2** Main Oven Knob
- 3** Left Medium Burner Knob
- 4** Large Burner Knob
- 5** Small Burner Knob
- 6** Right Medium Burner Knob
- 7** Ignition Button

## Before first use

---

### Rating plate

- This is usually situated on the front frame of the appliance and can be seen upon opening the door.  
Alternatively the rating plate may also be found on the back or top of some models (where applicable).
- **Do not remove the rating plate from the appliance as this may invalidate the guarantee.**

### Preparing to use your appliance

- Carefully check whether there is any damage after you unpack the appliance. If there is any defect; do not use the appliance and contact your retailer immediately. As the materials used for packaging (nylon, stapler, Styrofoam etc.) may cause harmful effects to children, they should be collected and removed immediately.
- For your safety wall coverings at the rear of the appliance should be securely fixed to the wall.
- Wipe over the base of the oven(s) with a soft cloth using hot soapy water. Wash the oven furniture before use.
- We suggest that you run the oven(s) and grill for 10 – 15 minutes at maximum tempera-

ture, to burn off any residue from their surfaces. Accessible parts may become hotter than in normal use. Children should be kept away. During this period an odour may be emitted, it is therefore advisable to open a window for ventilation.

### Condensation and steam

- When food is heated it produces steam similar to a boiling kettle. The vents allow some of this steam to escape. However, always stand back from the appliance when opening the door(s) to allow any build up of steam or heat to release.
- If the steam comes into contact with a cool surface on the outside of the appliance, e.g. a trim, it will condense and produce water droplets. This is quite normal and is not caused by a fault on the appliance.
- To prevent discolouration, regularly wipe away condensation and foodstuff from surfaces.

### Cookware

- Do not use baking trays larger than 25cmx30cm (10") (12") as they will restrict the circulation of heat and may affect performance.

## Grill and oven furniture

- The following items of grill and oven furniture have been supplied with the appliance. If you require replacements of any of the items listed below please contact your local service force centre.

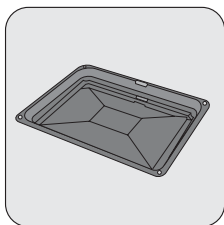

1 grill pan

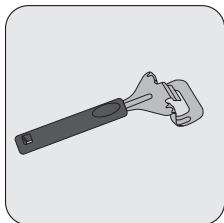

1 grill pan handle

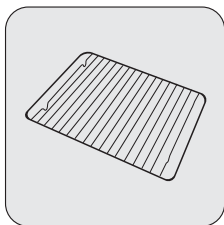

1 grill pan grid

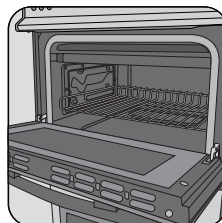

1 straight shelf  
(For grilling and top  
oven cooking)

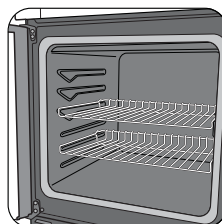

2 straight shelves  
(For main oven cook-  
ing)

## The hob

The gas hob has different burner sizes to suit different types of cooking.

To ensure maximum burner efficiency only use pots and pans with flat bases appropriate to the burner size used.

## Using the hob

### To light the hob burners

The hob ignition works by means of a battery. Lift up the lid. You can not use the hob when the lid is down.

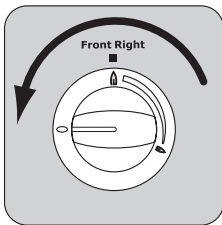

Push in and hold the control knob, turn to the large flame symbol (highest setting).

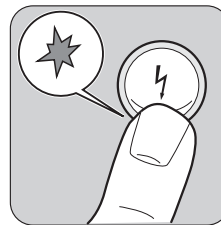

Press the ignition button immediately. Keep the control knob depressed for up to 5 seconds, but no longer than 10 seconds.

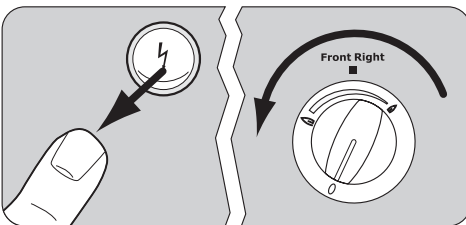

After this time release the controls. The flame should remain alight. If after 10 seconds the burner has not lit, stop operating the appliance and wait at least 1 minute before attempting a further ignition of the burner. When the burner has lit release the control and ignition button, adjust the setting as required.

#### **! WARNING!**

In the event of the burner flame being accidentally extinguished, turn off the burner control and do not attempt to re-ignite the burner for at least 1 minute.

#### **! WARNING!**

Ensure the pan supports are correctly fitted before using the hob.

#### **! WARNING!**

If the ignition button is not pressed immediately a build up of gas may cause the flame to spread.

## Pans

To get the best efficiency from your appliance and for your safety, use the following pan sizes for each burner.

Rapid Burner: 22-26 cm  
Medium Burner: 14-22 cm  
Auxillary Burner: 12-18 cm

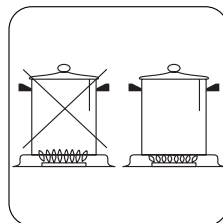

## To turn off any burner

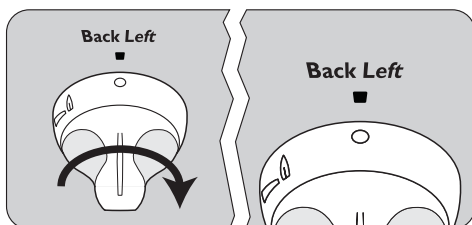

Turn the control knob to the off position. This is shown by a dot. Turn knob clockwise until dot position is reached. Do not attempt to turn the burner off by turning the knob counter-clockwise.

### **!** WARNING!

When lighting any burner, ensure that it is lit before you leave the appliance. When turning off a burner, ensure the flame has gone out before leaving the appliance.

### **!** IMPORTANT!

If you are having any difficulty lighting a hob burner turn all the hob controls off and make sure the burner parts have been replaced correctly.

## Hints and tips

- Do not overfill pans or they will boil over.
- Do not use pans with very heavy handles, which cause the pan to tip.
- The hob surface should be allowed to cool before closing the lid.

### **!** WARNING!

Place pans on the centre of the burners. Position pans so the handles cannot be accidentally knocked or overhang the appliance. Lift pans on and off the pan supports. Do not slide them across the hob.

- Any spillage should be removed from the lid before opening.
- Do not leave accidental spillage on the hob or removable parts. The spillage should be wiped up and the parts washed and carefully dried as soon as the hob, pan supports and burner parts are cool enough to touch.
- A flat-based Wok will stand stable on the pan supports. If you use a round Wok with a collar support, the collar must be the open wire-work type otherwise the performance of the burner will be affected.

**! WARNING!**

Take care to avoid burns and scalds when reaching across the hotplate.

**! WARNING!**

Take extra care when deep fat frying, do not cover the pan with a lid. Do not leave a pan unattended. If the pan catches fire, leave it where it is and turn off all controls. Place a damp cloth or a fitting lid over the pan to smother the flames. Never put water on the fire. Leave to cool for 30 minutes.

**! WARNING!**

Do not use the lid as a work surface or chopping board. This could damage the glass and reduce it's strength.

**! WARNING!**

Gas flame safety device (FSD) is used for cutting off the gas feed to the burners in case the

flames are accidentally put out by wind, overflowing liquids, etc. To activate this feature, press the knob during ignition, and when the ignition occurs, keep it pressed for 5 seconds, but no longer than 10 seconds. When the flame is accidentally put out, the device will cut out the gas flow. To see if your appliance is equipped with FSD, please refer to "Model Recognition Table" on page 26.

**! WARNING!**

For your safety, the glass hob lid is equipped with a safety valve that will cut out the gas feed to the hob burners in case the lid is lowered. However, the oven and grill burners will continue to operate regardless of the position of the hob lid. This function must not be used for controlling the burners. The gas will continue to flow when the lid is lifted and will not reignite until manual intervention.

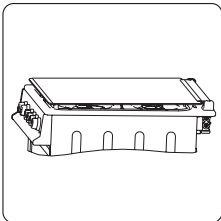

Gas hob off

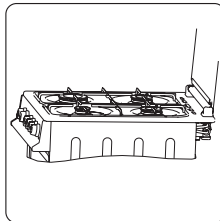

Gas hob on

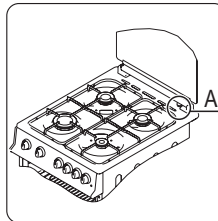

Shut off mechanism

# The grill

## **CAUTION!**

Accessible parts may be hot when the grill is in use. Young children should be kept away.

## **IMPORTANT!**

When you first operate the grill you may hear some sounds as the burner heats up, this is quite normal and is not a fault on the appliance.

## Using the grill

Fully open the door before lighting the grill.

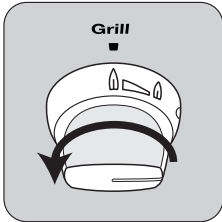

Push in and hold the control knob, turn to the large flame symbol (highest setting).

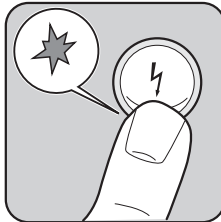

Press the ignition button immediately.

Keep the control knob depressed for up to 5 seconds, but no longer than 10 seconds. After this time release the controls. The flame should remain alight. If after 10 seconds the burner is not lit, stop operating the appliances and wait at least 1 minute before attempting a further ignition of the burner.

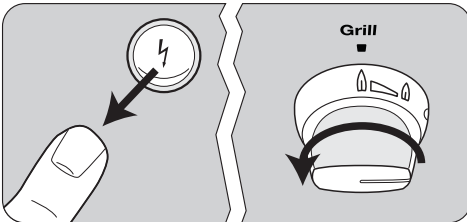

When the burner has lit release the control and ignition button, adjust the setting as required.

## **WARNING!**

The grill door must be left open when grilling.

## To turn off the grill

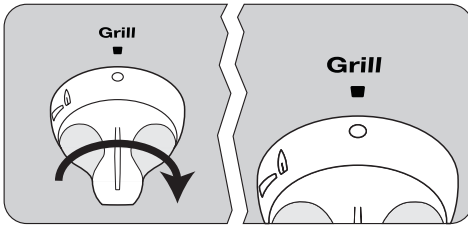

Turn the control knob to the off position shown by a dot.

**! WARNING!**

Never cover the grill pan or grid with foil as this can lead to grill fires.

**! WARNING!**

Ensure that the grill is turned off before closing the door.

## The grill pan and handle

**! WARNING!**

Always use an oven glove to protect your hand when using the grill as all the metal parts can become very hot!

The grill pan has a detachable handle. Ensure to locate the tip of grill pan handle inside the recessed form as indicated in the figure below. Do not leave the handle in position when grilling. If the handle is left in position when grilling, it will get very hot.



The grill pan

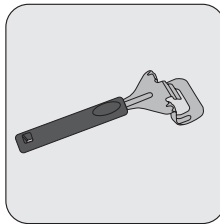

The grill pan handle

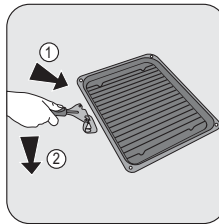

**! WARNING!**

Ensure the handle is properly located.

**! WARNING!**

Protect your hands when removing the grill pan handle. Always remove the grill pan handle during grilling. Place the grill pan on the shelf so that the pan is positioned centrally beneath the grill.

## Hints and tips

- Most foods should be placed on the grid in the grill pan to allow maximum circulation of air to lift the food out of the fats and juices.
- Adjust the grid and grill pan runner position to allow for different thicknesses of food.
- Food should be thoroughly dried before grilling to minimise splashing. Brush lean meats and fish lightly with a little oil or melted butter to keep them moist during cooking.

- Accompaniments such as tomatoes and mushrooms may be placed underneath the grid when grilling meats.
- When toasting bread use the shelf in position 1 with the grid in the high position.
- Preheat the grill on a full setting for a few minutes before sealing steaks or toasting.

Adjust the heat setting and the shelf as necessary during cooking.

- The food should be turned over during cooking as required.

## Grilling chart

FOOD	GRILL TIME (mins in total)
Bacon Rashers	0:10 - 0:15
Beef Burgers	0:15 - 0:20
Chicken Joints	0:40 - 0:50
Lamb Chops	0:20 - 0:30
Pork Chops	0:20 - 0:30
Whole Trout/Mackerel	0:20 - 0:30
Plaice/Cod Fillets	0:15 - 0:25
Kebabs	0:20 - 0:30
Kidneys - Lamb/Pig	0:15 - 0:20
Liver - Lamb/Pig	0:15 - 0:30
Sausages	0:20 - 0:30
Steak - Rare	0:06 - 0:12
Steak - Medium	0:12 - 0:16
Steak - Well Done	0:14 - 0:20
Toasted Sandwiches	0:05 - 0:10

### **IMPORTANT!**

The times quoted above are given as a guide and should be adjusted to suit personal taste.

# The main oven

## Heat zones

There are zones of heat within the oven. The temperature in the middle is the gas mark you have chosen. The top of the oven is slightly hotter and the lower shelf slightly cooler. The base of the oven is quite a lot cooler. You can make use of these heat zones when you are cooking foods requiring different temperatures all at the same time. If you are cooking more than one tray of similar items, for example cakes or biscuits, swap the trays during cooking or you can remove the top tray when the food is cooked and move the lower tray to the higher shelf to finish cooking.

## Preheating

When you need to preheat the oven, we recommend you do so for 20 minutes. For recipes needing high temperatures, e.g. bread, pastries, scones, soufflés etc., best results are achieved if the oven is preheated first. For best results when cooking frozen or cooked chilled ready meals always preheat the oven first.

## Using the main oven

Fully open the door before lighting the main oven.

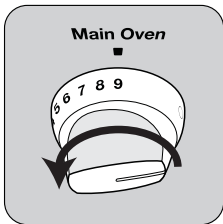

Push in and hold the control knob, turn to gas mark 9.

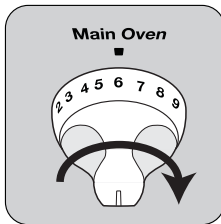

Press the ignition button immediately. Keep the control knob depressed for up to 5 seconds, but no longer than 10 seconds. After this time release the controls. The flame should remain alight. If after 10 seconds the burner has not lit, stop operating the appliance and wait at least 1 minute before attempting a further ignition of the burner. When the burner has lit release the control and ignition button, adjust the setting as required.

## To turn the main oven off

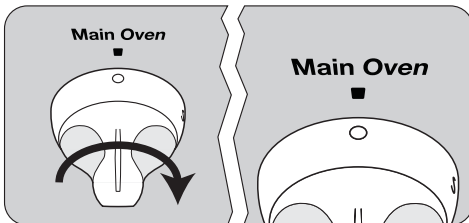

Turn the control knob to the off position. This is shown by a dot.

## S Slow Cook Function

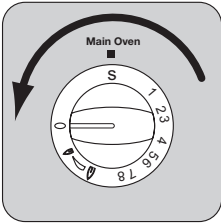

The food needs to be cooked at Gas mark 6 for 30 minutes before the oven is turned down to "Slow Cook". This ensures that the central temperature of the food gets hot enough to start the food cooking.

## Hints and tips

- Arrange the shelves in the required positions before switching the oven on. Shelf positions are numbered from bottom upwards.

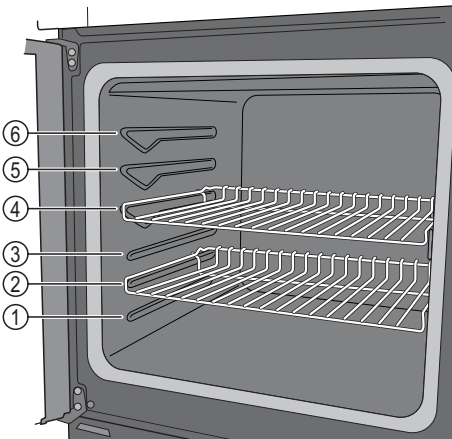

- Stand dishes on a suitably sized baking tray on the shelf to prevent spillage onto the oven base and to help reduce cleaning.
- The material and finish of the baking tray and dishes used affect base browning. Enamelware, dark, heavy or non-stick utensils increase base browning. Shiny aluminium or polished steel trays reflect the heat away and give less base browning.
- When cooking more than one dish in the oven, place dishes centrally on different shelves rather than cluster several dishes on one shelf, this will allow the heat to circulate freely for the best cooking results.
- If you are cooking more than one tray of similar items, for example cakes or biscuits, swap the trays during cooking or you can remove the top tray when the food is cooked and move the lower tray to the higher shelf to finish cooking.
- Do not place baking trays directly on the oven base as it interferes with the oven air circulation and can lead to base burning; use the lower shelf position.

### **WARNING!**

Do not place cookware and cooking pots with rough bases e.g. cast iron on the oven door as damage to the glass may occur.

## Cooking tables

### Oven cooking chart

The temperature and baking times are for guidance only, as these will depend on the consistency of the various ingredients and the number, type and size of baking tray or tins used. It may be necessary to increase or decrease the temperature to suit individual pref-

erence and requirements. For best results, moist recipes (for example pizza, fruit flans etc) should be baked on one level. To ensure optimal performance when cooking convenience foods, pizza or frozen and chilled ready meal, always preheat the oven first.

Food	Gas mark	Pos.	Approximate cook time (h)
Biscuits	5	3 + 5	0:15 - 0:25
Bread	g <sup>1)</sup>	4	0:30 - 0:45
Bread rolls/buns	g <sup>1)</sup>	4	0:15 - 0:30
Small / Queen Cakes	5	6 + 4	0:20 - 0:30
Sponges	4	3 + 5	0:25 - 0:35
Victoria Sandwich	4	3 + 5	0:25 - 0:35
Madeira Cake	4	4	1:15 - 1:45
Rich Fruit Cake	2	3	2:30 - 3:00
Christmas Cake	2	3	4:00 - 5:15
Gingerbread	2	3	1:15 - 1:45
Meringues	1	3	2:30 - 3:15
Flapjack	5	3	0:30 - 0:35
Shortbread	3	3	0:45 - 1:00
Fruit Pies, Crumbles	6	3	0:45 - 1:00
Milk Puddings	2	3	1:30 - 2:15
Scones	7	3 + 5	0:08 - 0:18
Choux Pastry	6	4	0:35 - 0:45
Éclairs / Profiteroles	5	4	0:25 - 0:35
Flaky Pastry	6	4	0:25 - 0:45
Mince Pies	5	3 + 5	0:15 - 0:30
Pasta Lasagne etc.	5	3	0:45 - 1:00

Food	Gas mark	Pos.	Approximate cook time (h)
Meat Pies	7	4	0:40 - 0:50
Quiche, Tarts, Flans	5	4	0:35 - 0:45
Shepherd's Pie	7	3	0:30 - 0:55
Soufflés	5	3	0:20 - 0:40
Fish	4	4	0:20 - 0:40
Fish Pie	6	3	0:30 - 0:40
Beef Casserole	3	2	2:30 - 3:15
Lamb Casserole	3	2	2:30 - 3:15
Convenience Foods	Follow manufacturer's instructions		
Baked Potatoes	5	4	1:30 - 2:15
Roast Potatoes	6	4	1:00 - 1:45
Large Yorkshire Puddings	7	5	0:35 - 0:45
Individual Yorkshire Puddings	7	5	0:15 - 0:30

1) When baking bread cook for 10 minutes at gas mark 8 then reduce to mark 6 for the remaining cook time.

### **IMPORTANT!**

Shelf positions are counted from the bottom of the oven.

### **IMPORTANT!**

To help pastry dishes brown on the underside cook on a metal plate or place on a baking tray.

## Roasting chart

Meat	Gas mark	Cooking time
Beef/ Beef boned	5	0:20 - 0:35 minutes per ½kg (1lb) and 0:20 - 0:35 minutes over.
Mutton/Lamb	5	0:25 - 0:35 minutes per ½kg (1lb) and 0:25 - 0:35 minutes over.
Pork/Veal/Ham	5	0:30 - 0:40 minutes per ½kg (1lb) and 0:30 - 0:40 minutes over.
Chicken	5	0:20 - 0:25 minutes per ½kg (1lb) and 0:20 minutes over.

Meat	Gas mark	Cooking time
Turkey/Goose	5	0:20 - 0:25 minutes per ½kg (1lb) up to 3½kg (7lb) then 0:10 minutes per ½kg (1lb) over 3½kg (7lb).
Duck	5	0:25 - 0:35 minutes per ½kg (1lb) and 0:25 - 0:30 minutes over.
Pheasant	5	0:35 - 0:40 minutes per ½kg (1lb) and 0:35 - 0:40 minutes over.
Rabbit	5	0:20 minutes per ½kg (1lb) and 0:20 minutes over.

### INTERNAL TEMPERATURES –

Rare: 50-60°C; Medium: 60-70°C; Well done: 70-80°C

The roasting temperatures and times given in the chart should be adequate for most joints, but slight adjustments may be required to allow for personal requirements and the shape and

texture of the meat. However, lower temperatures and longer cooking times are recommended for less tender cuts, or larger joints.

Wrap joints in foil if preferred, for extra browning uncover for the last 0:20 – 0:30 min. cooking time.

## Care and cleaning



### **WARNING!**

Before cleaning always allow the appliance to cool down.

### Cleaning materials

- Before using any cleaning materials on your appliance, check that they are suitable and that their use is recommended by the manufacturer.
- Cleaners that contain bleach should not be used as they may dull the surface finishes. Harsh abrasives and scourers should also be avoided.

### Cleaning the outside of the appliance

- Do not use abrasive cleaning materials e.g. abrasive cream cleaners, wire wool pads or scourers on painted or printed finishes as damage may occur. Regularly wipe over the control panel, control knobs, handles, doors and appliance sides using a soft cloth and hot soapy water. To prevent streaking, finish with a soft cloth.
- Stainless Steel cream cleaners are abrasive and should be avoided as they may dull the surface finish. **Any spillage on the stainless steel finish must be wiped off immediately.**

## **WARNING!**

Do not attempt to remove any of the control knobs from the appliance as this may cause damage and is a safety hazard.

## Cleaning the hob

- Clean the hob using a mild abrasive.
- Take care not to damage the spark electrodes. If the spark electrodes are damaged the burners will not light. You can remove the pan supports, burner caps and burner crowns to clean them. Again take care not to damage the spark electrodes.
- Clean the burner crowns and pan supports by soaking them in very hot soapy water.
- Aluminium based saucepans can leave shiny metal marks on the pan supports. You can remove any stubborn stains by scouring with a soap impregnated steel wool pad. If you look after the burner crowns and pan supports in this way they will stay reasonably clean. However the surface will dull with time. After cleaning the appliance parts, dry them thoroughly before you put them back.

## When replacing hob burner parts

1. Crown to body. (Do not try to force the crown on to the body). Make sure that the hole in the crown is over the electrode. Check that the location pegs sit in the slots in the body. When the crown is in this position let it fall freely on to the body. Check that the crown can be moved slightly from side to side.
2. Cap to crown. Place cap centrally on the top of crown (enamel side up). Move sideways and front to back to check the cap is properly fitted.

3. Check for ignition. If a burner will not light then you need to check the crown and cap positions.

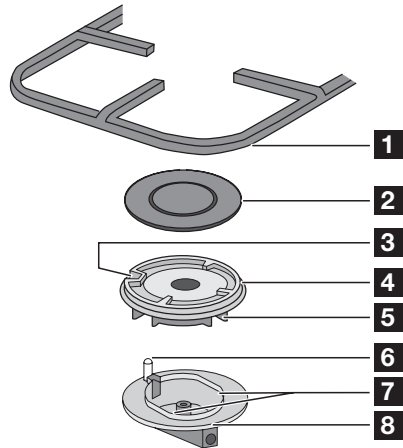

- 1 Pan Support
- 2 Cap
- 3 Hole
- 4 Crown
- 5 Location peg
- 6 Electrode
- 7 Slots
- 8 Body

## Cleaning the grill/oven furniture

- All removable parts, except the grill pan handle can be washed in the dishwasher.
- The grill pan, grill pan grid and oven shelves may be cleaned using a soap impregnated steel wool pad. Soaking first in hot soapy water will make cleaning easier.

## Cleaning the grill

Do not clean the grill burner itself. Cleaning the grill may cause the holes in the burner to become blocked preventing it from operating correctly. Due to the nature of stainless steel the grill burner may tarnish through use over a period of time. This is quite normal and is not a fault on the appliance. Clean the area around the grill frequently using hot soapy water.

## Cleaning inside the grill and oven compartments

- The vitreous enamel main oven and grill compartment can be cleaned using normal oven cleaners with care. Ensure that the manufacturers instructions are followed and that all parts are well rinsed afterwards.

### **! WARNING!**

Aerosol cleaners must not come into contact with elements, the door seal, or any painted finishes as this may cause damage.

## To remove the inner door glass

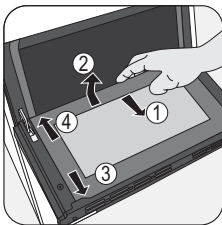

## Cleaning the door(s)

### **! WARNING!**

To prevent damaging or weakening the door glass panels avoid the use of the following:

- Household detergents and bleaches.
- Soap impregnated pads unsuitable for non-stick saucepans.
- Abrasive cleaning pads, scourers and steel wool pads.
- Chemical oven pads or aerosols.
- Rust removers.
- Bath/Sink stain removers.

## Cleaning between the outer and inner door glass

### **IMPORTANT!**

Please note that the door glass on your product may differ in type and shape from that shown in the diagrams.

Before cleaning the oven door glasses, you must pull out the inner glass as shown:

- Push the glass towards direction 1 and release from the location bracket.
- Pull out the glass towards direction 2.

After cleaning:

- Push the glass towards under the cover (towards direction 3).
- Place the glass under the location bracket (towards direction 4).

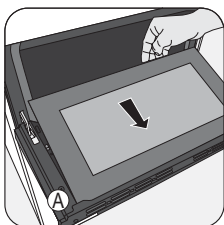
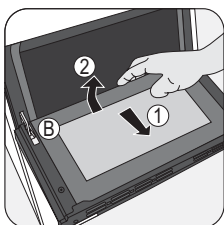

If the oven door is the triple glass oven door, the third glass can also be pulled out the same way as second glass.

After cleaning:

- Push the glass towards under the location bracket "A".
- Place the glass under location bracket "B".

## To clean the glass door panels

Clean the outer and inner glass using hot soapy water or hob cleaner may be used. Do not use hob cleaner on the Stainless Steel or painted finishes.

### **WARNING!**

If the door glass panel becomes chipped or has deep scratches the glass will be weakened and

must be replaced to prevent the possibility of the panel shattering. Please contact your local service force centre who will be pleased to advise further.

### **WARNING!**

Do not attempt to use the oven without the glass being in place.

## What to do if...

Maintenance must only be carried out by a competent/qualified person. Do not try to alter/modify the appliance yourself, as this could be dangerous.

We recommend that your appliance has an annual gas safety check carried out by our approved service agent. Please carry out the following checks on your appliance before calling a Service Engineer. It may be that the

problem is a simple one that you can solve yourself without the expense of a service call. **In-guarantee customers should make sure that the checks have been made as the engineer will make a charge if the fault is not a mechanical or electrical breakdown.** Please note that proof of purchase is required for in-guarantee service calls.

Problem	Possible solution
The grill and oven do not work.	<ul style="list-style-type: none"> <li>• Check that there is not a problem with your gas supply. You can do this by making sure the other gas appliances such as central heating or gas fires are working.</li> <li>• The battery may need replacing</li> <li>• If you have checked the above: Allow the appliance to cool for a couple of hours. The appliance should now be working normally.</li> </ul>
The oven is not cooking evenly.	<ul style="list-style-type: none"> <li>• Check that the appliance is correctly installed and is level.</li> <li>• Check that the recommended temperatures and shelf positions are being used.</li> </ul>
The oven temperature is too high or too low.	<ul style="list-style-type: none"> <li>• Check that the recommended temperatures and shelf positions are being used. Be prepared to adjust the temperature up or down slightly to achieve the results you want.</li> </ul>
The hob burners will not light.	<ul style="list-style-type: none"> <li>• Ensure the burner parts have been placed correctly.</li> <li>• The battery may need replacing.</li> <li>• Check that there is not a problem with your gas supply. You can do this by making sure the other gas appliances such as central heating or gas fires are working.</li> </ul>
The flame colour is orange/yellow.	<ul style="list-style-type: none"> <li>• Due to the design of the burner the flame can appear to be orange/yellow (flame disturbance) in certain areas of the burner this is a natural occurrence.</li> </ul>
The burner is not igniting or only partially lighting.	<ul style="list-style-type: none"> <li>• Check that the burner is dry and that food spillage or cleaning fluids are not present on the burner. This can be dried with a cloth and stubborn marks cleaned away with a dry nylon brush (old toothbrush etc.)</li> </ul>
The burner sounds noisy.	<ul style="list-style-type: none"> <li>• It is natural for the burners to emit noise as the gas is being drawn through the burner and may reduce as they heat up.</li> </ul>
The burner is emitting a popping sound.	<ul style="list-style-type: none"> <li>• This is a natural occurrence when the burner is alight and does not affect the performance of the burner.</li> </ul>

Problem	Possible solution
Noise	<ul style="list-style-type: none"> <li>It is normal for some metal parts on the cooker to produce noise when in use, this is due to expansion and contraction when heating up and cooling down.</li> </ul>

## Technical Data

<b>Dimensions</b>	
Height:	900mm (nominal)
Width:	500mm (nominal)
Depth:	600mm (nominal)
Weight:	47.3Kg
Space for fixing at hob level	2mm minimum clearance
Space for fixing above hob level	See important note location of appliance
Minimum space above hob level	787mm (If a cooker hood is fitted refer to the cooker-hood installation instructions)
<b>Connections</b>	
Gas connection	Rear left hand side of appliance at hob level. Rc ½" ( ½ " B.S.P. female)
Electrical connection	None
Ignition	Battery 1.5 Volt AA size

GAS CONSUMPTION TABLE	LPG GB: I3+ IE: I3+	NG GB: I2H
<b>LARGE BURNER</b>		
INJECTOR	85	115
NOMINAL RATING (KW)	3	3
CONSUMPTION IN 1h	218.3 gr/h	285.7 lt/h
<b>MEDIUM BURNER</b>		
INJECTOR	65	97

GAS CONSUMPTION TABLE	LPG GB: I3+ IE: I3+	NG GB: I2H
NOMINAL RATING (KW)	1.75	1.75
CONSUMPTION IN 1h	127.25 gr/h	166.7 lt/h
<b>SMALL BURNER</b>		
INJECTOR	50	72
NOMINAL RATING (KW)	1	1
CONSUMPTION IN 1h	72.7 gr/h	95.3 lt/h
<b>MAIN OVEN BURNER</b>		
INJECTOR	98	115
NOMINAL RATING (KW)	2.4	2.4
CONSUMPTION IN 1h	174.5 gr/h	228.6 lt/h
<b>GRILL BURNER</b>		
INJECTOR	68	110
NOMINAL RATING (KW)	2.2	2.2
CONSUMPTION IN 1h	160 gr/h	209.5 lt/h

This appliance complies with: European Council Directives Low voltage Directive 73/23/EEC,

Gas Directive 90/396/EEC EMC Directive 89/336/EEC, CE Marking Directive 93/68/EEC.

# Installation

MODEL RECOGNITION TABLE			
MODEL NAME	COLOR	GAS TYPE <sup>1)</sup>	HOB FSD <sup>2)</sup>
ZKG5020WN1	WHITE	NG	NO <sup>3)</sup>
ZKG5020WFN	WHITE	NG	YES
ZKG5020SN1	SILVER	NG	YES
ZKG5020WL1	WHITE	LPG	YES
ZKG5020SL1	SILVER	LPG	YES
ZKG5020BL1	BROWN	LPG	YES

1) For more information, refer to Technical Data on page 24.

2) For more information, refer to FSD warning clause on page 11.

3) This appliance is not suitable for installation in flats or other multi occupancy dwellings as defined in clause 8.2.1 of IGE/G/5.

## Safety requirements

- Natural Gas / LPG versions of this appliance are available.
- Check that this model is suitable for the type of supply available. This appliance must be installed and/or serviced by a competent person in accordance with the Gas Safety (Installation and Use) Regulations Current Editions and the I.E.E. Wiring Regulations.
- Detailed recommendations are contained in the following British Standard Codes of Practice - BS.6172, BS.5440: Part 2 and B.S. 6891. All British Standards must be 'Current Editions'.
- For appliances installed in the Republic of Ireland please refer to NSAI – Domestic Gas Installation IS813 Current Editions and the ETCI Rules for Electrical Installations. In the Republic of Ireland a signed Declaration of Conformity is issued by the installer (IS813 Current Editions Annex D.1).

## **WARNING!**

This appliance must be installed by a qualified electrician / competent person (CORGI Registered). Safety may be impaired if installation is not carried out in accordance with these instructions. Do not alter the electrical circuitry of this appliance.

## Provision for ventilation

- This appliance is not connected to a combustion products evacuation device. It should be installed and connected in accordance with the current installation regulations. Particular attention should be given to the relevant requirements regarding ventilation.

- The room containing the appliance should have an air supply in accordance with BS. 5440: Part 2 Current Edition. All rooms require an openable window or equivalent and some rooms will require a permanent vent as well. For room volumes up to 5m<sup>3</sup> an air vent of 100cm<sup>2</sup> is required: for room volumes between 5m<sup>3</sup> and 10m<sup>3</sup> an air vent of 50cm<sup>2</sup> is required. . If the room has a door that opens directly to the outside, no air vent is required. For room volumes that exceed 11m<sup>3</sup> no air vent is required. If there are other fuel burning appliances in the same room, BS.5440: Part 2 Current Edition should be consulted to determine the requisite air vent requirements.
- Prolonged intensive use of the appliance may call for additional ventilation, for example opening a window, or more effective ventilation, for example increasing the level of mechanical ventilation where present.

## Moving your appliance

- You may damage some soft or badly fitted floor coverings when you move the appliance. The floor covering under the appliance should be securely fixed so it does not ruck up when you move the appliance across it. Alternatively you could remove the floor covering. This appliance is heavy and care must be taken when moving it. Do not try to move the appliance by pulling the door handles.
- To move the appliance, open the grill door. Raise the appliance off its front feet by lifting it from inside the oven. Pull the appliance forward. When you replace the appliance push it back to the stop and make sure there is the same gap at each rear corner.

## For your safety

- Do not try to disconnect the appliance from the gas supply if the supply pipe does not have a bayonet connection, as described in the installation instructions. If this is the case contact the person who installed the appliance.

## Location of appliance

- This appliance must not be installed in a bed-sitting room of volume less than 20m<sup>3</sup> or in a bathroom, shower room or garage. It is essential that the appliance is positioned as shown.
- Curtains must not be fitted immediately behind the appliance or within 150mm of the sides of the hotplate. If fitted next to or between two base units a minimum space of 1mm must be left between each unit and the sides of the appliance. The hob must be set to a minimum of 7mm above the adjacent units. (Note: The levelling feet fitted to the appliance will achieve a nominal height of 907mm -5+ 13mm. Base units not meeting the above conditions must be a minimum of 100mm away from the hob.

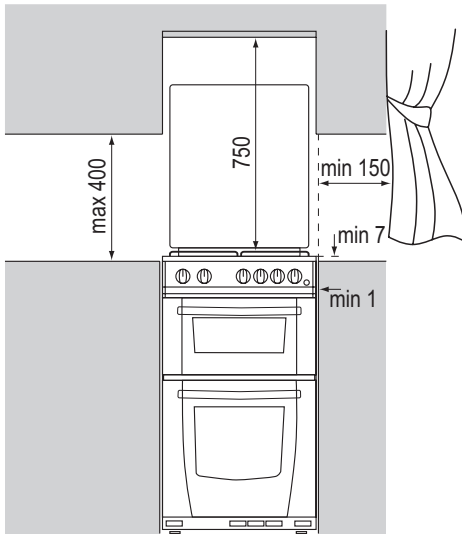

- For appliances installed in the Republic of Ireland please refer to NSAI-Domestic Gas Installation IS813 Current Edition Section 7 Permitted Locations of appliance Table 4--- Locations and Permanent Ventilation requirements-flueless appliances. Note: - L.P.G. cookers MUST NOT be installed below ground level i.e. in a basement or aboard any boat, yacht or other vessel.

## Levelling the appliance

- Adjustment to suit floor conditions or height is obtained by rotating clockwise or anti clockwise the feet at the front and rear of the appliance. A spirit level should be placed on one of the shelves to confirm the appliance is correctly levelled.

## Connecting to gas supply

- This appliance is designed to be installed with an appliance flexible connection only.
- Supply piping should not be less than R3/8. Connection is made to the Rc 1/2 (1/2" B.S.P) female threaded entry pipe located just below the hob level on the rear left hand side of the appliance.

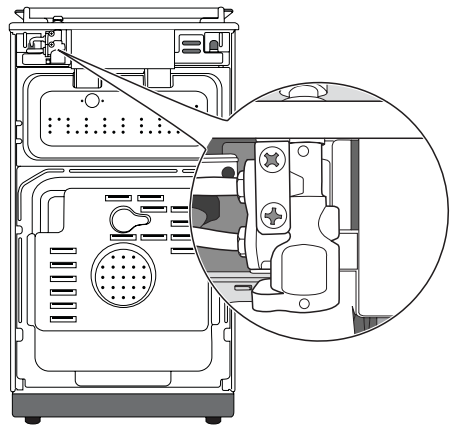

### **IMPORTANT!**

Only liquid sealants to be used when inlet gas pipe is fitted i.e.: do not use P.T.F.E. sealant tape.

- Carry out a gas tightness test after connecting to the gas supply.
- The gas bayonet connector must be fitted in the enlarged area indicated.
- Take into account that it must be possible to pull the appliance forward sufficiently. Ensure the hose does not become trapped when pushing the appliance into position.

**IMPORTANT!**

Flexible tubing used must comply with BS. 669 current edition.

LPG Flexible connections must be a type suitable for L.P.G and capable of operation up to 50 mbar and carry a red stripe, band or label.

**Fixing the stability chain**

To further prevent tilting and for safe usage of the appliance a stability chain should be used. Unscrew the screw shown in the figure. Then, align the first loop of the chain with the hole and assemble with the screw so that the chain stands in its place safely. Check the assembly by gently pulling the chain from its loose end. Fix the loose end to the rear wall as appropriate for your kitchen. The chain is not supplied within the package of the appliance, but can easily be supplied from the market.

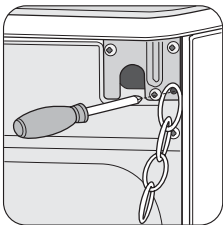
**The battery****⚠ WARNING!**

After unpacking, install the battery in the battery box as explained below. The battery is placed in the document bag.

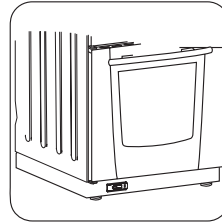

1. The battery is located on the left hand side of the front plinth.
2. To gain access to the battery, open the main oven door and lift up the battery holder lid.
3. Fit the new battery ensuring (+) terminal is next to the (+) sign on the battery.

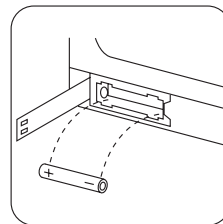

4. Close the lid of the battery holder.

**Pressure testing**

1. The Rapid injector is used as a pressure test point.
2. Connect the pressure gauge to the Rapid injector.
3. Check the supply pressure by turning the Rapid burner on and one other hob burner full on and light the appropriate burner. The pressure should be either:
  - For Natural Gas 20mbar
  - For LP. Gas. The pressure must be set to 29 mbar for use on butane or 37 mbar for use on propane.

4. Turn off the taps, disconnect the pressure gauge.
5. Check operation of each hob burner.

## Checking the grill

- Place the grill pan containing the grid, with the handle attached, into the grill compartment. To light the grill burner push in and hold the control knob, turn to the large flame symbol (highest setting). Press the ignition button immediately. Keep the control knob depressed for up to 5 seconds, but no longer than 10 seconds. After this time release the controls. The flame should remain alight. If after 10 seconds the burner has not lit, stop operating the appliance and wait at least 1 minute before attempting a further ignition of the burner. When the burner has lit release the control and ignition button, adjust the setting as required.

## Checking the hob

- Lift the lid. Fit the burner crowns and caps ensuring that they are correctly seated. Fit the pan supports.
- To light the hob burner push in and hold the control knob, turn to the large flame symbol (highest setting). Press the ignition button immediately. If the appliance is equipped with, FSD you can also check the FSD system by the following procedure: keep the control knob depressed for up to 5 seconds, but no longer than 10 seconds. After this time release the controls. The flame should remain alight. If after 10 seconds the burner has not lit, stop operating the appliance and wait at least 1 minute before attempting a further ignition of the burner. When the burner has lit release the control and ignition button, adjust the setting as required. Turn

off the hob and wait 1 minute. Turn the hob control knob to the large flame symbol (highest setting). DO NOT depress or attempt to ignite the burner. No gas should flow.

## Checking the main oven

1. To light the main oven burner push in and hold the control knob, turn to gas mark 9 Press the ignition button immediately. Keep the control knob depressed for up to 5 seconds, but no longer than 10 seconds. After this time release the controls. The flame should remain alight. If after 10 seconds the burner has not lit, stop operating the appliance and wait at least 1 minute before attempting a further ignition of the burner. When the burner has lit release the control and ignition button.
2. After 1 minute check that the flame covers the full width of the burner and is stable.
3. Set the oven control to Mk 2, close the oven door and check that after about 10 minutes the flame size has reduced.
4. Turn off the control and check that the oven flames go out.

## Checking lid shut-off device

1. Lift the lid.
2. To light the hob burner push in and hold the control knob, turn to the large flame symbol (highest setting) Press the ignition button immediately. Keep the control knob depressed for up to 5 seconds, but no longer than 10 seconds. After this time release the controls. The flame should remain alight. If after 10 seconds the burner has not lit, stop operating the appliance and wait at least 1 minute before attempting a further ignition

- of the burner. When the burner has lit release the control and ignition button.
3. Close the lid. There should now be no gas supply to the hotplate and the burner will go out.
  4. Turn off the hob and lift the lid. The gas supply should now be restored to the hob, when the control is turned on.

### **IMPORTANT!**

Instruct the user on how to use the appliance and its ignition system. Refer the user to the wording inside this manual which gives advice on the safe operation of the appliance.

## Environmental Information

The symbol  on the product or on its packaging indicates that this product may not be treated as household waste. Instead it should be taken to the appropriate collection point for the recycling of electrical and electronic equipment. By ensuring this product is disposed of correctly, you will help prevent potential negative consequences for the environment and human health, which could otherwise be caused by inappropriate waste

handling of this product. For more detailed information about recycling of this product, please contact your local council, your household waste disposal service or the shop where you purchased the product.

After installation please dispose of the packaging with due regard for safety and the environment. Your local authority can arrange this.

## Guarantee/Customer Service

### GREAT BRITAIN & IRELAND

#### Standard guarantee conditions

We, Electrolux, undertake that if within 12 months of the date of the purchase this Electrolux appliance or any part thereof is proved to be defective by reason only of faulty workmanship or materials, we will, at our option repair or replace the same FREE OF CHARGE for labour, materials or carriage on condition that:

- The appliance has been correctly installed and used only on the electricity supply stated on the rating plate.

- The appliance has been used for normal domestic purposes only, and in accordance with the manufacturer's instructions.
- The appliance has not been serviced, maintained, repaired, taken apart or tampered with by any person not authorised by us.
- Electrolux Service Force Centre must undertake all service work under this guarantee
- Any appliance or defective part replaced shall become the Company's property.
- This guarantee is in addition to your statutory and other legal rights.

#### Exclusions

- Damage or calls resulting from transportation, improper use or neglect, the replacement of any light bulbs or removable parts of glass or plastic.
- Costs incurred for calls to put right an appliance which is improperly installed or calls to appliances outside the United Kingdom.
- Appliances found to be in use within a commercial environment, plus those which are subject to rental agreements.
- Products of Electrolux manufacturer that are not marketed by Electrolux

### Service and Spare Parts

In the event of your appliance requiring service, or if you wish to purchase spare parts, please contact your local Service Force Centre by telephoning

**0870 5 929 929**

Your telephone call will be automatically routed to the Service Force Centre covering your postcode area.

For the address of your local Service Force Centre and further information about Service Force, please visit the website at

**[www.serviceforce.co.uk](http://www.serviceforce.co.uk)**

Before calling out an engineer, please ensure you have read the details under the heading "What to do if..."

When you contact the Service Force Centre you will need to give the following details:

1. Your name, address and postcode.
2. Your telephone number.
3. Clear concise details of the fault.
4. The model and Serial number of the appliance (found on the rating plate).
5. The purchase date.

Please note a valid purchase receipt or guarantee documentation is required for in guarantee service calls.

### Customer Care

For general enquiries concerning your Electrolux appliance, or for further information on Electrolux products please contact our Customer Care Department by letter or telephone at the address below or visit our website at [www.electrolux.co.uk](http://www.electrolux.co.uk)

Customer Care Department Electrolux Major Appliances Addington Way Luton Bedfordshire, LU4 9QQ

	Tel:
Electrolux	08705 950 950 (*)
AEG-Electrolux	08705 350 350 (*)
Zanussi-Electrolux	08705 727 727 (*)

(\*) Calls may be recorded for training purposes

**For Customer Service in The Republic of Ireland please contact us at the address below:**

Electrolux Group (Irl) Ltd Long Mile Road, Dublin 12, Republic of Ireland Tel: +353 (0)1 4090751 Email: [service.eid@electrolux.ie](mailto:service.eid@electrolux.ie)







**ZANUSSI**

 Electrolux

[www.electrolux.com](http://www.electrolux.com)

[www.zanussi-electrolux.co.uk](http://www.zanussi-electrolux.co.uk)