

EN

User manual

Freezer

# USER MANUAL

ZFT10210WA

**ZANUSSI**

# Contents

Safety instructions _____	2	Care and cleaning _____	7
Control panel _____	4	What to do if... _____	8
First use _____	5	Technical data _____	9
Daily use _____	6	Installation _____	9
Helpful Hints and Tips _____	6	Environmental concerns _____	12

Subject to change without notice.

## Safety instructions

In the interest of your safety and to ensure the correct use, before installing and first using the appliance, read this user manual carefully, including its hints and warnings. To avoid unnecessary mistakes and accidents, it is important to ensure that all people using the appliance are thoroughly familiar with its operation and safety features. Save these instructions and make sure that they remain with the appliance if it is moved or sold, so that everyone using it through its life will be properly informed on appliance use and safety.

For the safety of life and property keep the precautions of these user's instructions as the manufacturer is not responsible for damages caused by omission.

### Children and vulnerable people safety

- This appliance is not intended for use by persons (including children) with reduced physical, sensory or mental capabilities, or lack of experience and knowledge, unless they have been given supervision or instruction concerning use of the appliance by a person responsible for their safety.  
Children should be supervised to ensure that they do not play with the appliance.
- Keep all packaging well away from children. There is risk of suffocation.
- If you are discarding the appliance pull the plug out of the socket, cut the connection cable (as close to the appliance as you can) and remove the door to prevent playing children to suffer electric shock or to close themselves into it.
- If this appliance featuring magnetic door seals is to replace an older appliance having a spring lock (latch) on the door or lid, be

sure to make that spring lock unusable before you discard the old appliance. This will prevent it from becoming a death trap for a child.

### General safety

#### Warning!

Keep ventilation openings, in the appliance enclosure or in the built-in structure, clear of obstruction.

- The appliance is intended for keeping food-stuff and/or beverages in a normal household and similar applications such as:
  - staff kitchen areas in shops, offices and other working environments;
  - farm houses and by clients in hotels, motels and other residential type environments;
  - bed and breakfast type environments;
  - catering and similar non-retail applications.
- Do not use a mechanical device or any artificial means to speed up the thawing process.
- Do not use other electrical appliances (such as ice cream makers) inside of refrigerating appliances, unless they are approved for this purpose by the manufacturer.
- Do not damage the refrigerant circuit.
- The refrigerant isobutane (R600a) is contained within the refrigerant circuit of the appliance, a natural gas with a high level of environmental compatibility, which is nevertheless flammable.  
During transportation and installation of the appliance, be certain that none of the com-

ponents of the refrigerant circuit become damaged.

If the refrigerant circuit should become damaged:

- avoid open flames and sources of ignition
  - thoroughly ventilate the room in which the appliance is situated
- It is dangerous to alter the specifications or modify this product in any way. Any damage to the cord may cause a short-circuit, fire and/or electric shock.

 **Warning!** Any electrical component (power cord, plug, compressor) must be replaced by a certified service agent or qualified service personnel to avoid hazard.

1. Power cord must not be lengthened.
  2. Make sure that the power plug is not squashed or damaged by the back of the appliance. A squashed or damaged power plug may overheat and cause a fire.
  3. Make sure that you can come to the mains plug of the appliance.
  4. Do not pull the mains cable.
  5. If the power plug socket is loose, do not insert the power plug. There is a risk of electric shock or fire.
  6. You must not operate the appliance without the lamp cover (if foreseen) of interior lighting.
- This appliance is heavy. Care should be taken when moving it.
  - Do not remove nor touch items from the freezer compartment if your hands are damp/wet, as this could cause skin abrasions or frost/freezer burns.
  - Avoid prolonged exposure of the appliance to direct sunlight.
  - Bulb lamps (if foreseen) used in this appliance are special purpose lamps selected for household appliances use only. They are not suitable for household room illumination.

 **Caution!** Do not place frozen food on the worktop since cold and vapour may produce water condensate within its inner side.

The resulting drip liquid may cause malfunctions. Therefore, do not place nor leave frozen items of any kind on the worktop.

### Daily Use

- Do not put hot pot on the plastic parts in the appliance.
- Do not store flammable gas and liquid in the appliance, because they may explode.
- Do not place food products directly against the air outlet on the rear wall. (If the appliance is Frost Free)
- Frozen food must not be re-frozen once it has been thawed out.
- Store pre-packed frozen food in accordance with the frozen food manufacturer's instructions.
- Appliance's manufacturers storage recommendations should be strictly adhered to. Refer to relevant instructions.
- Do not place carbonated or fizzy drinks in the freezer compartment as it creates pressure on the container, which may cause it to explode, resulting in damage to the appliance.
- Ice lollies can cause frost burns if consumed straight from the appliance.

### Care and cleaning

- Before maintenance, switch off the appliance and disconnect the mains plug from the mains socket.
- Do not clean the appliance with metal objects.
- Do not use sharp objects to remove frost from the appliance. Use a plastic scraper.
- Never use a hair drier or other heating appliances to speed up defrosting. Excessive heat may damage the plastic interior, and humidity could enter the electric system making it live.

### Installation

**Important!** For electrical connection carefully follow the instructions given in specific paragraphs.

- Unpack the appliance and check if there are damages on it. Do not connect the appliance if it is damaged. Report possible damages

immediately to the place you bought it. In that case retain packing.



- It is advisable to wait at least four hours before connecting the appliance to allow the oil to flow back in the compressor.
- Adequate air circulation should be around the appliance, lacking this leads to overheating. To achieve sufficient ventilation follow the instructions relevant to installation.
- Wherever possible the back of the product should be against a wall to avoid touching or catching warm parts (compressor, condenser) to prevent possible burn.
- The appliance must not be located close to radiators or cookers.
- Make sure that the mains plug is accessible after the installation of the appliance.
- Connect to potable water supply only (If a water connection is foreseen).

### Service

- Any electrical work required to do the servicing of the appliance should be carried out by a qualified electrician or competent person.

- This product must be serviced by an authorized Service Centre, and only genuine spare parts must be used.

### Environment Protection

 This appliance does not contain gasses which could damage the ozone layer, in either its refrigerant circuit or insulation materials. The appliance shall not be discarded together with the urban refuse and rubbish. The insulation foam contains flammable gases: the appliance shall be disposed according to the applicable regulations to obtain from your local authorities. Avoid damaging the cooling unit, especially at the rear near the heat exchanger. The materials used on this appliance marked by the symbol  are recyclable.

## Control panel

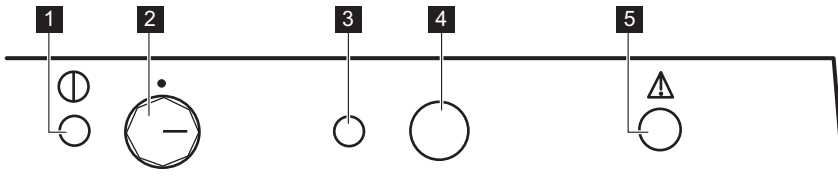

- 1 Green On/Off Indicator Light
- 2 Temperature Regulator and On/Off Switch
- 3 Yellow Fast Freeze Indicator Light
- 4 Acoustic Signal Stop and Fast Freeze Switch
- 5 Red Alarm Indicator Light

### Switching on

1. Allow the appliance to stand for 4 hrs after installation.
2. Insert the plug into the wall socket.

3. Turn the Temperature Regulator clockwise to a temperature lower than  $\ll - 16\text{ }^{\circ}\text{C}$   $\gg$  position.
4. The Green On/Off Indicator Light will light up and Red Alarm Indicator Light will blink.
5. The lighting up of the Green On/Off Indicator Light means that the appliance is switched on.
6. The blinking of the Red Alarm Indicator Light means an improper temperature in the freezing compartment. In addition, an intermittent sound can be heard, which can

be stopped by pressing the Acoustic Signal Stop and Fast Freeze Switch once.

7. When switching on the freezer for the first time, the Red Alarm Indicator Light will blink until the internal temperature has reached a level required for the safe conservation of frozen food.

### Switching off

1. To turn off the appliance, turn the Temperature Regulator to the "O" position.
2. To disconnect the appliance from the power disconnect the mains plug from the wall socket.

### Temperature regulation

The temperature within the appliance is controlled by the Temperature Regulator situated on the control panel.

To operate the appliance, proceed as follows:

- turn the Temperature Regulator toward lower settings to obtain the minimum coldness.
- turn the Temperature Regulator toward higher settings to obtain the maximum coldness.

 A medium setting is generally the most suitable.

However, the exact setting should be chosen keeping in mind that the temperature inside the appliance depends on:

- room temperature
- how often the door is opened
- the quantity of food stored
- the location of the appliance.

### Red Alarm Indicator Light

Under normal operating conditions, the internal temperature of the freezer will ensure the long-term conservation of the stored food.

When such temperature rises above a certain level (-12 °C), the appliance will trigger an

## First use

### Cleaning the interior

Before using the appliance for the first time, wash the interior and all internal accessories with lukewarm water and some neutral soap so

acoustic and light alarm. The light alarm is a blink red light (Red Alarm Indicator Light), while the acoustic alarm is an intermittent sound. You can stop the acoustic alarm by pressing the Acoustic Signal Stop Switch once.

 When switching on the freezer for the first time, the Red Alarm Indicator Light will blink until the internal temperature has reached a level required for the safe conservation of frozen food.

### Fast Freeze function

If more than 3-4 kg of food is to be frozen:

1. Press the Fast Freeze Switch for 2-3 seconds to activate the fast-freeze function 6-24 hours before placing the fresh food in the freezer, the Yellow Fast Freeze Indicator Light will illuminate. The compressor will now run continuously, to ensure that the fresh food is frozen as quickly as possible.
2. It is possible to deactivate the function at any time by pressing the Fast Freeze Switch for 2-3 seconds.
3. Place the foods in the freezing compartments (indicated with graphics).
4. Once the food is completely frozen (it may take up to 24 hours) you can manually switch off the fast-freeze function by pressing the Fast Freeze Switch for 2- 3 seconds and the Yellow Fast Freeze Indicator light will also go out.
5. Move frozen food from the freezing compartments into the other compartments (storing compartments) to make room for another freezing.

 If the Fast Freeze Switch is accidentally left on, the fast-freeze function will be automatically switched off 48 hours later. The Yellow Fast Freeze Indicator light will also go out.

as to remove the typical smell of a brand-new product, then dry thoroughly.

**Important!** Do not use detergents or abrasive powders, as these will damage the finish.

## Daily use

---

### Freezing fresh food

The freezer compartments (indicated with graphics) are suitable for freezing fresh food and storing frozen and deep-frozen food for a long time.

To freeze fresh food activate the fast freeze function.

The maximum amount of food that can be frozen in 24 hours is specified on the **rating plate**, a label located on the inside of the appliance.

The freezing process lasts 24 hours: during this period do not add other food to be frozen.

### Storage of frozen food

When first starting-up or after a period out of use, before putting the products in the com-

partment let the appliance run at least 2 hours on the higher settings.

**Important!** In the event of accidental defrosting, for example due to a power failure, if the power has been off for longer than the value shown in the technical characteristics chart under "rising time", the defrosted food must be consumed quickly or cooked immediately and then re-frozen (after cooling).

### Thawing

Deep-frozen or frozen food, prior to being used, can be thawed at room temperature.

Small pieces may even be cooked still frozen, directly from the freezer: in this case, cooking will take longer.

## Helpful Hints and Tips

---

### Normal Operating Sounds

- You may hear a faint gurgling and a bubbling sound when the refrigerant is pumped through the coils or tubing. This is correct.
- When the compressor is on, the refrigerant is being pumped around and you will hear a whirring sound and a pulsating noise from the compressor. This is correct.
- The thermic dilatation might cause a sudden cracking noise. It is natural, not dangerous physical phenomenon. This is correct.
- When the compressor switches on or switches off, you will hear a faint "click" of the temperature regulator. This is correct.

### Hints for freezing

To help you make the most of the freezing process, here are some important hints:

- the maximum quantity of food which can be frozen in 24 hrs. is shown on the rating plate;
- the freezing process takes 24 hours. No further food to be frozen should be added during this period;
- only freeze top quality, fresh and thoroughly cleaned, foodstuffs;

- prepare food in small portions to enable it to be rapidly and completely frozen and to make it possible subsequently to thaw only the quantity required;
- wrap up the food in aluminium foil or polythene and make sure that the packages are airtight;
- do not allow fresh, unfrozen food to touch food which is already frozen, thus avoiding a rise in temperature of the latter;
- lean foods store better and longer than fatty ones; salt reduces the storage life of food;
- water ices, if consumed immediately after removal from the freezer compartment, can possibly cause the skin to be freeze burnt;
- it is advisable to show the freezing in date on each individual pack to enable you to keep tab of the storage time.

### Hints for storage of frozen food

To obtain the best performance from this appliance, you should:

- make sure that the commercially frozen foodstuffs were adequately stored by the retailer;

- be sure that frozen foodstuffs are transferred from the foodstore to the freezer in the shortest possible time;
- not open the door frequently or leave it open longer than absolutely necessary;
- once defrosted, food deteriorates rapidly and cannot be refrozen;
- do not exceed the storage period indicated by the food manufacturer.

## Care and cleaning

 **Caution!** Unplug the appliance before carrying out any maintenance operation.

 This appliance contains hydrocarbons in its cooling unit; maintenance and recharging must therefore only be carried out by authorized technicians.

### Periodic cleaning

The equipment has to be cleaned regularly:

- clean the inside and accessories with luke-warm water and some neutral soap.
- regularly check the door seals and wipe clean to ensure they are clean and free from debris.
- rinse and dry thoroughly.

**Important!** Do not pull, move or damage any pipes and/or cables inside the cabinet. Never use detergents, abrasive powders, highly perfumed cleaning products or wax polishes to clean the interior as this will damage the surface and leave a strong odour.

Clean the condenser (black grill) and the compressor at the back of the appliance with a brush. This operation will improve the performance of the appliance and save electricity consumption.

**Important!** Take care of not to damage the cooling system.

Many proprietary kitchen surface cleaners contain chemicals that can attack/damage the plastics used in this appliance. For this reason it is recommended that the outer casing of this appliance is only cleaned with warm water with a little washing-up liquid added. After cleaning, reconnect the equipment to the mains supply.

### Defrosting of the freezer

The freezer compartment of this model, on the other hand, is a "no frost" type. This means that there is no buildup of frost when it is in operation, neither on the internal walls nor on the foods.

The absence of frost is due to the continuous circulation of cold air inside the compartment, driven by an automatically controlled fan.

### No-Frost technology

In order to facilitate the removal of the ice layer, the evaporator is assisted by electric heating during the defrosting procedure. The ventilator is in OFF position. The defrost water will drip in the tray placed at the compressor and will evaporate. In the course of the defrosting procedure (approx. 30 minutes) the evaporator becomes warm but it has no influence on the internal temperature.

The foods should be kept well-packed in order to avoid any moisture loss as a result of air circulation.

Do not obstruct the vent holes.

It is recommended to put all foods in the baskets in the freezer compartment.

### Periods of non-operation

When the appliance is not in use for long periods, take the following precautions:

1. disconnect the appliance from electricity supply
2. remove all food
3. clean the appliance and all accessories
4. leave the lid open to prevent unpleasant smells.

**Important!** If the cabinet will be kept on, ask somebody to check it once in a while to prevent the food inside from spoiling in case of a power failure.

## What to do if...

**Warning!** Before troubleshooting, disconnect the mains plug from the mains socket.

Only a qualified electrician or competent person must do the troubleshooting that is not in this manual.

**Important!** There are some sounds during normal use (compressor, refrigerant circulation).

**Important!** The appliance operates discontinuously, so the stopping of compressor does not mean being no current. That is why you must not touch the electrical parts of the appliance before breaking the circuit.

Problem	Possible cause	Solution
<b>The appliance is noisy</b>	The appliance is not supported properly	Check if the appliance stands stable (all the four feet should be on the floor)
<b>The compressor operates continually</b>	The thermostatic control is set incorrectly	Set a warmer temperature
	Doors are not shut properly or do not close tightly	Check if the doors close well and the gaskets are undamaged and clean
	The door has been opened too frequently	Do not leave the door open longer than necessary
	Large quantities of food to be frozen were put in at the same time	Wait some hours and then check the temperature again
	Food placed in the appliance was too warm	Allow food to cool to room temperature before storing
<b>There is too much frost and ice</b>	The room temperature is too high.	Decrease the room temperature
	Products are not wrapped properly	Wrap the products better
	Doors are not shut properly or do not close tightly	Check if the doors close well and the gaskets are undamaged and clean
<b>It is too warm in the freezer</b>	The Temperature regulator may be set incorrectly	Set a warmer temperature
	Temperature regulator may be set incorrectly	Set a lower temperature
	The door does not close tightly or it is not shut properly	Check if the door closes well and the gasket is undamaged and clean
	Large quantities of food to be frozen were put in at the same time	Insert smaller quantities of food to be frozen at any one time.
	Food placed in the appliance was too warm	Allow food to cool to room temperature before storing.
	Products to be frozen are placed too closely to each other	Place the products in a way so that cold air could circulate among them



Problem	Possible cause	Solution
<b>It is too cold inside the freezer</b>	Temperature regulator may be set incorrectly	Set a warmer temperature
<b>The appliance does not work at all. Neither cooling nor lighting works</b>	Plug is not connected to the mains socket properly	Connect the mains plug properly
	Power does not reach the appliance	Try connecting another electrical device to the power outlet
	The appliance is not switched on	Switch on the appliance
	There is no voltage in the mains socket (try to connect another appliance into it)	Call an electrician
<b>The appliance does not cool at all</b>	Plug is not connected to the mains socket properly	Connect the mains plug properly
	There is no voltage in the mains socket (try to connect another appliance into it)	Call an electrician
	The appliance is not switched on	Switch on the appliance
	Temperature Regulator is not on	Check the Temperature Regulator
<b>Green indicator flashing</b>	Temperature sensor problem	Call the service personnel

### Closing the door

1. Clean the door gaskets.
2. If necessary, adjust the door. Refer to "Installation".

3. If necessary, replace the defective door gaskets. Contact the Service Center.

## Technical data

Dimension		
	Height	850 mm
	Width	595 mm
	Depth	635 mm
Rising Time		13 h
Voltage		230 V
Frequency		50 Hz

The technical information are situated in the rating plate on the internal left side of the appliance and in the energy label.

## Installation

**Caution!** Read the "Safety Information" carefully for your safety and correct operation of the appliance before installing the appliance.

### Positioning

This appliance can be installed in a dry, well ventilated indoor, also in a garage or cellar, but for optimum performance install this appliance at a location where the ambient temperature corresponds to the climate class indicated on the rating plate of the appliance:

Climate class	Ambient temperature
SN	+10°C to + 32°C
N	+16°C to + 32°C
ST	+16°C to + 38°C
T	+16°C to + 43°C

### Levelling

When placing the appliance ensure that it stands level. This can be achieved by two adjustable feet at the bottom in front .

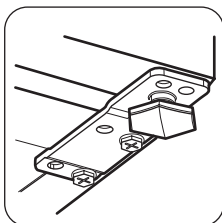

### Location

The appliance should be installed well away from sources of heat such as radiators, boilers, direct sunlight etc. Ensure that air can circulate

freely around the back of the cabinet. To ensure best performance, if the appliance is positioned below an overhanging wall unit, the minimum distance between the top of the cabinet and the wall unit must be at least 100 mm . Ideally, however, the appliance should not be positioned below overhanging wall units. Accurate levelling is ensured by one or more adjustable feet at the base of the cabinet.

If the cabinet is placed in a corner and the side with the hinges facing the wall, the distance between the wall and the cabinet must be at least 10 mm to allow the door to open enough so that the shelves can be removed.

**Warning!**

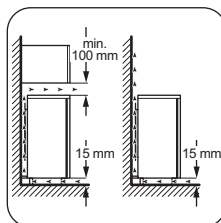

It must be possible to disconnect the appliance from the mains power supply; the plug must therefore be easily accessible after installation.

### Door reversibility

**Important!** To carry out the following operations, we suggest that this be made with another person that will keep a firm hold on the doors of the appliance during the operations.

To change the opening direction of the door, do these steps:

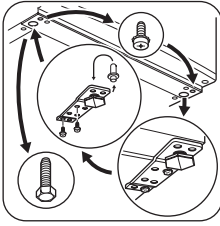

1. Remove the plug from the power socket.
2. Tilt back the appliance carefully so that the compressor cannot touch the floor.
3. Unscrew the left feet.
4. Unscrew the screws of the door bottom hinge.

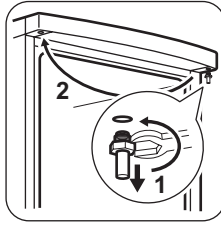

5. Take off the appliance door by pulling it slightly downwards.
6. Unscrew the top door hinge pin of the appliance then screw it back on the other side.
7. Fit the appliance door on the upper door hinge pin.

8. Remove the lower hinge. Put over the pin in the direction of the arrow.

9. Unscrew and install the screw on the opposite side.

10. Install the lower hinge on the opposite side leaving the position of the door unchanged.

11. Screw in the one screw in the place set free on the other side as well as the right feet.

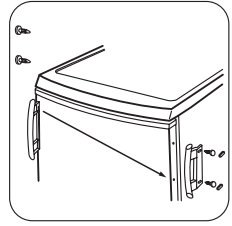

12. Remove and install the handle (if foreseen) on the opposite side.

13. Reposition, level the appliance, wait for at least four hours and then connect it to the power socket.

Do a final check to make sure that:

- All screws are tightened.
- The door opens and closes correctly.

If the ambient temperature is cold (i.e. in Winter), the gasket may not fit perfectly to the cabinet. In that case, wait for the natural fitting of the gasket.

In case you do not want to carry out the above mentioned operations, contact the nearest After Sales Service Force. The After Sales Service specialist will carry out the reversibility of the doors at your cost.

### Electrical Connection

**Caution!** Any electrical work required to install this appliance should be carried out by a qualified electrician or competent person.

**Warning!** This appliance must be earthed. The manufacturer declines any liability should these safety measures not be observed.

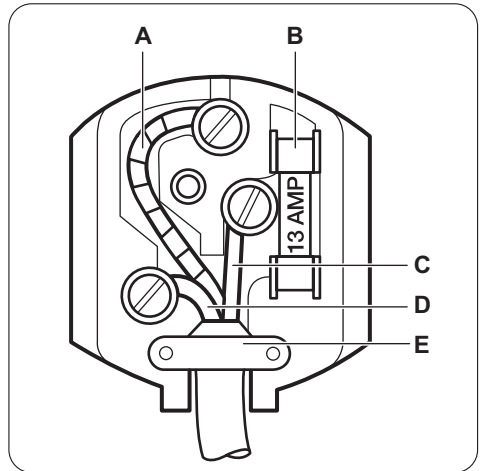

**Important!** The wires in the mains lead are coloured in accordance with the following code:

- |          |                   |       |
|----------|-------------------|-------|
| <b>A</b> | Green and Yellow: | Earth |
| <b>C</b> | Brown:            | Live  |

**D** Blue: Neutral

As the colours of the wires in the mains lead of this appliance may not correspond with the coloured markings identifying the terminals in your plug, proceed as follows:

1. Connect the wire coloured green and yellow to the terminal marked either with the letter "E" or by the earth symbol  or coloured green and yellow.
2. Connect the wire coloured blue to the terminal either marked with the letter "N" or coloured black.
3. Connect the wire coloured brown to the terminal either marked with the "L" or coloured red.

## Environmental concerns

---

The symbol  on the product or on its packaging indicates that this product may not be treated as household waste. Instead it should be taken to the appropriate collection point for the recycling of electrical and electronic equipment. By ensuring this product is disposed of correctly, you will help prevent

4. Check that no cut, or stray strands of wire is present and the cord clamp **E** is secure over the outer sheath.
5. Make sure the electricity supply voltage is the same as that indicated on the appliance rating plate.
6. Switch on the appliance.

The appliance is supplied with a 13 amp plug fitted **B**. In the event of having to change the fuse in the plug supplied, a 13 amp ASTA approved (BS 1362) fuse must be used.

 **Warning!** A cut off plug inserted into a 13 amp socket is a serious safety (shock) hazard. Ensure that it is disposed of safely.

potential negative consequences for the environment and human health, which could otherwise be caused by inappropriate waste handling of this product. For more detailed information about recycling of this product, please contact your local council, your household waste disposal service or the shop where you purchased the product.

---

---

---

---

---

---

---

---

---

---

---

---

---

---

---

---

---

---

---

---

---

---

---

---

---

---

---

---

---

---







[www.zanussi.com/shop](http://www.zanussi.com/shop)



212000207-A-482012