



CONTENTS

1. SAFETY INFORMATION.....	3
2. SAFETY INSTRUCTIONS.....	4
3. PRODUCT DESCRIPTION.....	6
4. CONTROL PANEL.....	7
5. BEFORE FIRST USE.....	8
6. DAILY USE.....	9
7. CLOCK FUNCTIONS.....	11
8. USING THE ACCESSORIES.....	12
9. ADDITIONAL FUNCTIONS.....	14
10. HINTS AND TIPS.....	15
11. CARE AND CLEANING.....	23
12. TROUBLESHOOTING.....	26

FOR PERFECT RESULTS

Thank you for choosing this AEG product. We have created it to give you impeccable performance for many years, with innovative technologies that help make life simpler features you might not find on ordinary appliances. Please spend a few minutes reading to get the very best from it.

Visit our website for:



Get usage advice, brochures, trouble shooter, service information:
www.aeg.com



Register your product for better service:
www.registeraeg.com



Buy Accessories, Consumables and Original spare parts for your appliance:
www.aeg.com/shop

CUSTOMER CARE AND SERVICE

Always use original spare parts.

When contacting our Authorised Service Centre, ensure that you have the following data available: Model, PNC, Serial Number.

The information can be found on the rating plate.



Warning / Caution-Safety information



General information and tips



Environmental information

Subject to change without notice.

1. ⚠ SAFETY INFORMATION

Before the installation and use of the appliance, carefully read the supplied instructions. The manufacturer is not responsible if an incorrect installation and use causes injuries and damages. Always keep the instructions with the appliance for future reference.

1.1 Children and vulnerable people safety

- This appliance can be used by children aged from 8 years and above and persons with reduced physical, sensory or mental capabilities or lack of experience and knowledge if they have been given supervision or instruction concerning use of the appliance in a safe way and understand the hazards involved.
- Do not let children play with the appliance.
- Keep all packaging away from children.
- Keep children and pets away from the appliance when it operates or when it cools down. Accessible parts are hot.
- If the appliance has a child safety device, we recommend you activate it.
- Cleaning and user maintenance shall not be made by children without supervision.
- Children of less than 3 years should be kept away unless continuously supervised.

1.2 General Safety

- Only a qualified person must install this appliance and replace the cable.
- Internally the appliance becomes hot when in operation. Do not touch the heating elements that are in the appliance. Always use oven gloves to remove or put in accessories or ovenware.
- Before maintenance cut the power supply.

- Ensure that the appliance is switched off before replacing the lamp to avoid the possibility of electric shock.
- Do not use a steam cleaner to clean the appliance.
- Do not use harsh abrasive cleaners or sharp metal scrapers to clean the glass door since they can scratch the surface, which may result in shattering of the glass.
- If the supply cord is damaged, it must be replaced by the manufacturer, its Authorised Service Centre or similarly qualified persons in order to avoid a hazard.
- To remove the shelf supports first pull the front of the shelf support and then the rear end away from the side walls. Install the shelf supports in the opposite sequence.
- The means for disconnection must be incorporated in the fixed wiring in accordance with the wiring rules.

2. SAFETY INSTRUCTIONS

2.1 Installation



WARNING!

Only a qualified person must install this appliance.

- Remove all the packaging.
- Do not install or use a damaged appliance.
- Obey the installation instruction supplied with the appliance.
- Always be careful when you move the appliance because it is heavy. Always wear safety gloves.
- Do not pull the appliance by the handle.
- Keep the minimum distance from the other appliances and units.
- Make sure that the appliance is installed below and adjacent safe structures.
- The sides of the appliance must stay adjacent to appliances or to units with the same height.

2.2 Electrical connection



WARNING!

Risk of fire and electrical shock.

- All electrical connections should be made by a qualified electrician.
- The appliance must be earthed.
- Make sure that the electrical information on the rating plate agrees with the power supply. If not, contact an electrician.
- Always use a correctly installed shockproof socket.
- Do not use multi-plug adapters and extension cables.
- Make sure not to cause damage to the mains plug and to the mains cable. Should the mains cable need to be replaced, this must be carried out by our Authorised Service Centre.
- Do not let mains cables touch or come near the appliance door, especially when the door is hot.
- The shock protection of live and insulated parts must be fastened in such a way that it cannot be removed without tools.

- Connect the mains plug to the mains socket only at the end of the installation. Make sure that there is access to the mains plug after the installation.
- If the mains socket is loose, do not connect the mains plug.
- Do not pull the mains cable to disconnect the appliance. Always pull the mains plug.
- Use only correct isolation devices: line protecting cut-outs, fuses (screw type fuses removed from the holder), earth leakage trips and contactors.
- The electrical installation must have an isolation device which lets you disconnect the appliance from the mains at all poles. The isolation device must have a contact opening width of minimum 3 mm.
- This appliance complies with the E.E.C. Directives.
- Do not put flammable products or items that are wet with flammable products in, near or on the appliance.

**WARNING!**

Risk of damage to the appliance.

- To prevent damage or discoloration to the enamel:
 - do not put ovenware or other objects in the appliance directly on the bottom.
 - do not put aluminium foil directly on the bottom of the appliance.
 - do not put water directly into the hot appliance.
 - do not keep moist dishes and food in the appliance after you finish the cooking.
 - be careful when you remove or install the accessories.
- Discoloration of the enamel has no effect on the performance of the appliance. It is not a defect in the sense of the warranty law.
- Use a deep pan for moist cakes. Fruit juices cause stains that can be permanent.
- This appliance is for cooking purposes only. It must not be used for other purposes, for example room heating.
- Always cook with the oven door closed.

2.3 Use

**WARNING!**

Risk of injury, burns and electrical shock or explosion.

- Use this appliance in a household only.
- Do not change the specification of this appliance.
- Make sure that the ventilation openings are not blocked.
- Do not let the appliance stay unattended during operation.
- Deactivate the appliance after each use.
- Be careful when you open the appliance door while the appliance is in operation. Hot air can release.
- Do not operate the appliance with wet hands or when it has contact with water.
- Do not apply pressure on the open door.
- Do not use the appliance as a work surface or as a storage surface.
- Open the appliance door carefully. The use of ingredients with alcohol can cause a mixture of alcohol and air.
- Do not let sparks or open flames to come in contact with the appliance when you open the door.

2.4 Care and cleaning

**WARNING!**

Risk of injury, fire, or damage to the appliance.

- Before maintenance, deactivate the appliance and disconnect the mains plug from the mains socket.
- Make sure the appliance is cold. There is the risk that the glass panels can break.
- Replace immediately the door glass panels when they are damaged. Contact the Service.
- Be careful when you remove the door from the appliance. The door is heavy!
- Clean regularly the appliance to prevent the deterioration of the surface material.

- Remaining fat or food in the appliance can cause fire.
- Clean the appliance with a moist soft cloth. Only use neutral detergents. Do not use abrasive products, abrasive cleaning pads, solvents or metal objects.
- If you use an oven spray, obey the safety instructions on the packaging.
- Do not clean the catalytic enamel (if applicable) with any kind of detergent.

2.5 Internal light

- The type of light bulb or halogen lamp used for this appliance is only for household appliances. Do not use it for house lighting.



WARNING!

Risk of electrical shock.

- Before replacing the lamp, disconnect the appliance from the power supply.
- Only use lamps with the same specifications.

2.6 Disposal



WARNING!

Risk of injury or suffocation.

- Disconnect the appliance from the mains supply.
- Cut off the mains cable and discard it.
- Remove the door catch to prevent children and pets to get closed in the appliance.

3. PRODUCT DESCRIPTION

3.1 General overview

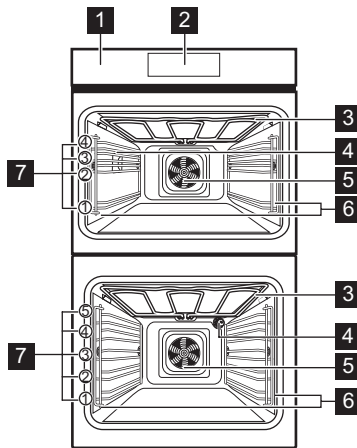

- 1 Control panel
- 2 Electronic programmer
- 3 Heating element
- 4 Lamp
- 5 Fan
- 6 Shelf support, removable
- 7 Shelf positions

3.2 Accessories

- **Wire shelf**
For cookware, cake tins, roasts.
- **Grill- / Roasting pan**
To bake and roast or as pan to collect fat.
- **Trivet**

For roasting and grilling.









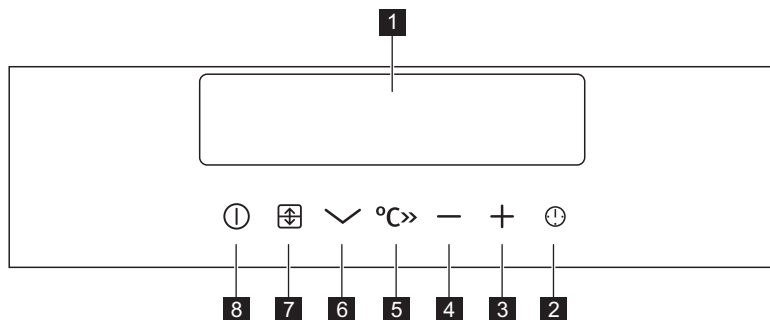

Use the trivet only with the Grill- / roasting pan.

- **Telescopic runners**
For shelves and trays.

4. CONTROL PANEL

4.1 Electronic programmer



Sensor Field	Function	Description
1	-	DISPLAY Shows the current settings of the appliance.
2		CLOCK To set the clock functions.
3		INCREASE To set the value for the temperature and time.
4		DECREASE To set the value for the temperature and time.
5		FAST HEAT UP To turn the Fast heat up function ON or OFF.
6		DOWN To move down in the menu.
7		OVEN SELECTION To switch between top and main oven.
8		ON / OFF To activate and deactivate the appliance.

4.2 Indicators on the display

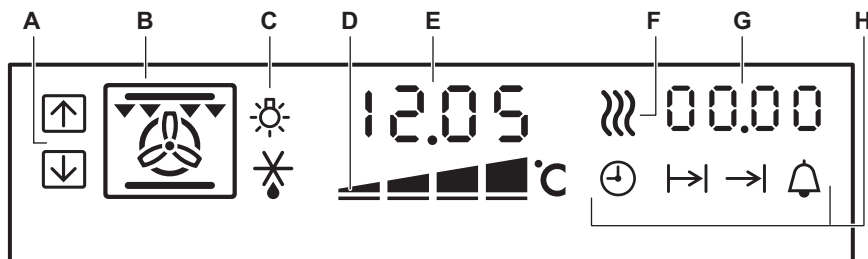

Name	Description
A	Top / Main oven indicator Shows which oven operates.
B	Oven function indicator Shows the function which is active.
C	Lamp / Defrost indicator Shows that the Lamp / Defrost function is active.
D	Heat-up and residual heat indicator Shows that the Heat-up / residual heat is active.
E	Temperature / Clock indicator Shows the temperature and the time in minutes.
F	Keep warm indicator Shows that keep warm function is active.
G	Cooking time / End time / Period of operation Shows the time setting for clock functions.
H	Clock function indicators Shows the clock function which is active.

4.3 Heat-up indicator

When you activate an oven function, the bars on the display come on one by one.

The bars show that the oven temperature increases.

5. BEFORE FIRST USE



WARNING!
Refer to Safety chapters.



Refer to "Care and cleaning" chapter.

5.1 Initial Cleaning

Remove all accessories and removable shelf supports from the appliance.

Clean the appliance before first use. Put the accessories and the removable shelf supports back to their initial position.

5.2 Setting the time



You must set the time before you operate the oven.

When you connect the appliance to the electrical supply or after a power cut, the indicator for the Time function flashes.

Press the **+** or **-** to set the correct time.

After approximately five seconds, the flashing stops and the display shows the time of day you set.

You can only change the time  if:



- The child safety device is not on.
- None of the clock functions Duration  or End  is set.
- No oven function is set.

5.3 Preheating

Preheat the empty appliance to burn off the remaining grease.



Preheat the two ovens. Heat up one oven at a time. Set the functions listed below, if applicable.

1. Set the function  and the temperature to 250°C. Let the appliance operate for 1 hour.
2. Set the function  and the temperature to 250°C. Let the appliance operate for 15 minutes.
3. Set the function  and the temperature to 250°C. Let the appliance operate for 15 minutes.

Accessories can become hotter than usual. The appliance can emit an odour and smoke. This is normal. Make sure that the airflow is sufficient.



6. DAILY USE







WARNING!









Refer to Safety chapters.

6.1 Selecting an oven





















1. To switch on the appliance press .
2. Repeatedly press  until the top / main oven indicator appears on the display.



6.2 Top oven functions

Symbol	Oven function	Application
	Light	To activate the lamp without a cooking function.
	True Fan Cooking	To bake on 1 shelf position and to dry food.
	Pizza Setting	To bake food on 1 shelf position for a more intensive browning and a crispy bottom.
	Slow Cooking	To prepare tender, succulent roasts.
	Turbo Grilling	To roast larger meat joints or poultry with bones on 1 shelf position. Also to make gratins and to brown.

Symbol	Oven function	Application
 	Fast Grilling	To grill flat food in large quantities and to toast bread.
 	Grilling	To grill flat food and to toast bread.
 	Defrost	To defrost frozen food.
 	Bottom Heat	To bake cakes with crispy bottom and to preserve food.
 CATA	Catalysis	To help the self-cleaning catalytic oven layer.

6.3 Main oven functions

Symbol	Oven function	Application
 	Light	To activate the lamp without a cooking function.
 	True Fan Cooking	To bake on up to 3 shelf positions at the same time and to dry food. Set the temperature 20 - 40 °C lower than for Conventional Cooking.
 	Pizza Setting	To bake food on 1 shelf position for a more intensive browning and a crispy bottom. Set the temperature 20 - 40 °C lower than for Conventional Cooking.
 	Slow Cooking	To prepare tender, succulent roasts.
 	Conventional Cooking	To bake and roast food on 1 shelf position.
 	Turbo Grilling	To roast larger meat joints or poultry with bones on 1 shelf position. Also to make gratins and to brown.
 	Fast Grilling	To grill flat food in large quantities and to toast bread.
 	Grilling	To grill flat food and to toast bread.
 	Keep Warm	To keep food warm.
 	Defrost	To defrost frozen food.



Symbol	Oven function	Application
 	Bottom Heat	To bake cakes with crispy bottom and to preserve food.
 CATA	Catalysis	To help the self-cleaning catalytic oven layer.

6.4 Setting the oven function

 You can change the oven function while the oven operates.

Press  to set an oven function. The display shows the recommended temperature. If you do not change the this temperature in less than approximately 5 seconds, the appliance starts to heat.

6.5 Changing the oven temperature

Press  or  to change the temperature.

When the appliance is at the set temperature, an acoustic signal sounds.

6.6 Deactivating the oven function





Press  until no oven function shows in the display.

6.7 Residual heat indicator

When you deactivate the oven, the display shows the residual heat.

7. CLOCK FUNCTIONS

7.1 Clock functions table

Clock function	Application
 Time of day	To set, change or check the time of day.
 Minute Minder	To set countdown time. This function has no effect on the operation of the appliance.
 Duration	To set the cooking time of the oven.
 End	To set the time of day when the oven should deactivate.



You can use the functions Duration \rightarrow and End \rightarrow at the same time to set the time for how long the appliance should operate and when the appliance should deactivate. This lets you activate the appliance with a delay in time. First set the Duration \rightarrow and then the End \rightarrow .

7.2 Setting the clock functions

For Duration \rightarrow and End \rightarrow set the oven function and temperature. This is not necessary for the Minute Minder . Refer to "Setting an oven function".

1. Use again and again until the display shows the necessary clock function.
2. Use $+$ or $-$ to set the necessary time.

The clock function operates. The display shows the indicator for the clock function you set.

When the time ends the indicator of the clock function and "00.00" flashes and an

acoustic signal sounds for 2 minutes. The appliance deactivates.

Touch a sensor field to stop the acoustic signal.



With Duration \rightarrow and End \rightarrow , the oven deactivates automatically.

7.3 Activating Heat + Hold (if applicable)



The temperature for the set oven function must be above 80°C.

The Heat+Hold function keeps prepared food warm for 30 minutes after the cooking is completed.

1. Set the time with the clock functions Duration \rightarrow and/or End \rightarrow .
2. Use again and again until the display shows the symbol Keep warm .
3. Use $+$ and the display shows "00:30".

When the function ends, an acoustic signal sounds. The oven deactivates automatically.

8. USING THE ACCESSORIES



WARNING!

Refer to Safety chapters.

8.1 Inserting the accessories

Wire shelf:

Push the shelf between the guide bars of the shelf support and make sure that the feet point down.

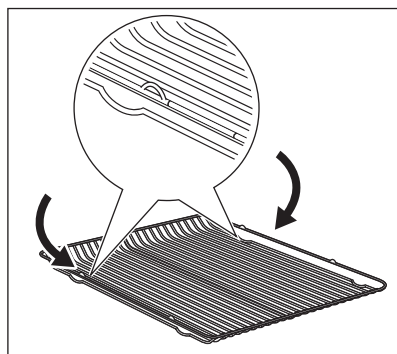

Deep pan:

Push the deep pan between the guide bars of the shelf support.

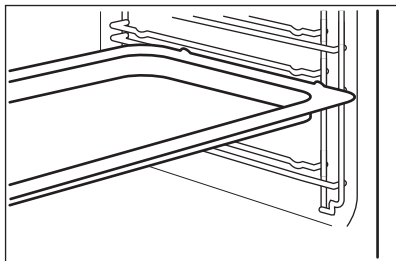

Wire shelf and the deep pan together:

Push the deep pan between the guide bars of the shelf support and the wire shelf on the guide bars above.

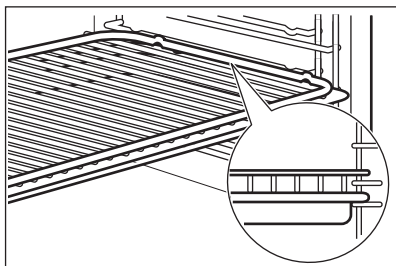

- All accessories have small indentations at the top of the right and left side to increase safety. The indentations are also anti-tip devices.
- The high rim around the shelf is a device which prevents cookware from slipping.

8.2 Telescopic runners - inserting the accessories



CAUTION!

Make sure you push back the telescopic runners fully in the appliance before you close the oven door.

Wire shelf:

Put the wire shelf on the telescopic runners so that the feet point downwards.



The high rim around the wire shelf is a special device to prevent the cookware from slipping.

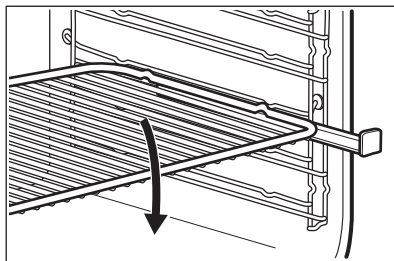

Baking tray or deep pan:

Put the baking tray or deep pan on the telescopic runners.

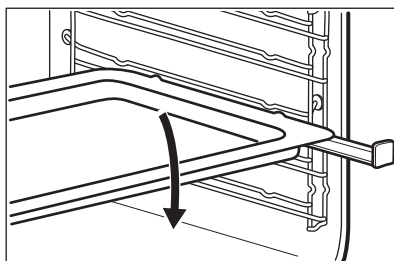

Wire shelf and deep pan together:

Put the wire shelf on the deep pan. Put the wire shelf and the deep pan on the telescopic runners.

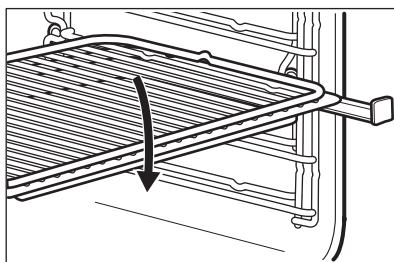

8.3 Trivet and Grill- / Roasting pan



WARNING!

Be careful when you remove the accessories from a hot appliance. There is a risk of burns.

You can use the trivet to roast larger pieces of meat or poultry on one shelf position.

1. Put the trivet into the deep pan so that the supports of the wire shelf point up.

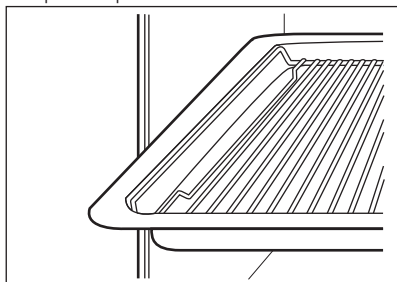

2. Put the deep pan into the oven on the necessary shelf position.

You can use the trivet to grill flat dishes in large quantities and to toast.

1. Put the trivet into the deep pan so that the supports of the wire shelf point down.

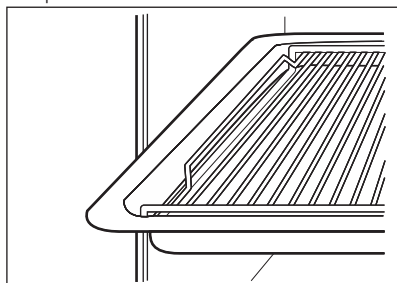

2. Put the deep pan into the oven on the necessary shelf position.

9. ADDITIONAL FUNCTIONS

9.1 Using the Child Lock

The Child Lock prevents an accidental operation of the appliance.

1. To activate the function deactivate the appliance with . Do not set an oven function.
2. Touch and hold and at the same time for 2 seconds.

An acoustic signal sounds.

SAFE comes on in the display.

To deactivate the Child Lock function repeat step 2.

9.2 Using the Function Lock

You can activate the function only when the appliance operates.

The Function Lock prevents an accidental change of the oven function.

1. Activate the oven.
2. Set the oven function.
3. Press and at the same time, until "LOC" comes on in the display.

To deactivate the Function Lock press and at the same time, until the display stops to show "LOC".



You can deactivate the appliance when the Function Lock is on. When you deactivate the appliance, the Function Lock deactivates.

9.3 Oven automatic switch-off

For safety reasons the appliance deactivates automatically after some time if a heating function operates and you do not change any settings.

Temperature	Switch-off time
30 °C - 115 °C	12.5 h
120 °C - 195 °C	8.5 h
200 °C - 245 °C	5.5 h
250 °C - maximum °C	3.0 h

After the Automatic switch-off, press a sensor field to operate the appliance again.



The oven automatic switch-off does not work with the Duration or End function.

9.4 Cooling fan

When the appliance operates, the cooling fan activates automatically to keep the surfaces of the appliance cool.

If you deactivate the appliance, the cooling fan can continue to operate until the appliance cools down.

10. HINTS AND TIPS



WARNING!
Refer to Safety chapters.



The temperature and baking times in the tables are guidelines only. They depend on the recipes and the quality and quantity of the ingredients used.

10.1 Double oven

Top oven

The top oven is the smaller of the two ovens. It has 4 shelf positions. Use it to cook smaller quantities of food. It gives especially good results when used to cook fruitcakes, sweets and savoury flants or quiche.

Main oven

The main oven is the bigger of the two ovens. It is particularly suitable for cooking larger quantities of food.

10.2 Baking

- Your oven can bake or roast differently to the appliance you had

before. Adapt your usual settings (temperature, cooking times) and shelf positions to the values in the tables.

- The manufacturer recommends that you use the lower temperature the first time.
- If you cannot find the settings for a special recipe, look for the one that is almost the same.
- You can extend baking times by 10 – 15 minutes if you bake cakes on more than one shelf position.
- Cakes and pastries at different heights do not always brown equally at first. If this occurs, do not change the temperature setting. The differences equalize during the baking procedure.
- With longer baking times, you can deactivate the oven approximately 10 minutes before the end of the baking time and then use the residual heat.

When you cook frozen food, the trays in the oven can twist during baking. When the trays become cold again, the distortions are gone.

10.3 Tips on baking

Baking results	Possible cause	Remedy
The bottom of the cake is not browned sufficiently.	The shelf position is incorrect.	Put the cake on a lower shelf.
The cake sinks and becomes soggy, lumpy or streaky.	The oven temperature is too high.	The next time you bake, set a slightly lower oven temperature.
The cake sinks and becomes soggy, lumpy or streaky.	The baking time is too short.	Set a longer baking time. You cannot decrease baking times by setting higher temperatures.

Baking results	Possible cause	Remedy
The cake sinks and becomes soggy, lumpy or streaky.	There is too much liquid in the mixture.	Use less liquid. Be careful with mixing times, especially if you use a mixing machine.
The cake is too dry.	The oven temperature is too low.	The next time you bake, set a higher oven temperature.
The cake is too dry.	The baking time is too long.	The next time you bake, set a shorter baking time.
The cake browns unevenly.	The oven temperature is too high and the baking time is too short.	Set a lower oven temperature and a longer baking time.
The cake browns unevenly.	The mixture is unevenly distributed.	Spread the mixture evenly on the baking tray.
The cake is not ready in the baking time given.	The oven temperature is too low.	The next time you bake, set a slightly higher oven temperature.

10.4 Baking

Top oven

Food	Temperature (°C)	Time (min)	Shelf position
Biscuits	170 - 190	10 - 20	2
Bread	200 - 220	30 - 35	1
Bread rolls / buns	170-180	10 - 15	1
Cakes:			
- Small & Queen	160 - 170	18 - 25	2
- Sponges	160 - 175	20 - 30	2
- Victoria Sandwich	160 - 170	18 - 25	2
- Madeira	140 - 150	75 - 90	2
- Rich Fruit	140 - 150	120 - 150	2
- Gingerbread	140 - 150	75 - 90	2
- Meringues	90 - 100	150 - 180	2
- Flapjack	160 - 170	25 - 30	2
- Shortbread	130 - 150	45 - 65	2
Casseroles:			
- Beef / Lamb	160 - 170	150 - 180	1

Food	Temperature (°C)	Time (min)	Shelf position
- Chicken	160 - 180	75 - 90	1
Convenience Foods	Follow manufacturer's instructions.		
Fish	170 - 190	20 - 30	2
Fish Pie (Potato Topped)	190 - 200	20 - 30	2
Fruit Pies, Crumbles	190 - 200	30 - 50	2
Milk Puddings	150 - 170	90 - 120	2
Pasta, Lasagne etc.	170 - 180	40 - 50	2
Pastry:			
- Choux	180 - 190	30 - 40	2
- Eclairs, Profiteroles	180 - 190	30 - 40	2
- Flaky / Puff Pies	210 - 220	30 - 40	2
Shortcrust:			
- Mince Pies	190 - 210	15 - 20	2
- Meat Pies	190 - 210	25 - 35	2
- Quiche, Tarts, Flans	180 - 200	25 - 50	2
Scones	220 - 230	8 - 12	2
Shepard's Pie	180 - 190	30 - 40	2
Souffles	190 - 200	20 - 30	2
Vegetables:			
- Baked Jacket Potatoes	180 - 190	60 - 90	2
- Roast Potatoes	180 - 190	60 - 90	2
Yorkshire Pudding:			
- Large	200 - 210	25 - 40	1
- Individual	210 - 220	15 - 25	1

Main oven

Food	Temperature (°C)		Time (min)	Shelf position
	Conventional Cooking	True Fan Cooking		
Biscuits	180 - 190	180 - 190	10 - 20	2
Bread	200 - 220	190 - 210	30 - 35	2
Cakes:				

Food	Temperature (°C)		Time (min)	Shelf position
	Conventional Cooking	True Fan Cooking		
- Small & Queen	170 - 180	160 - 170	18 - 25	2
- Sponges	170 - 180	160 - 170	20 - 25	2
- Madeira	150 - 160	140 - 160	60 - 75	2
- Rich Fruit	140 - 150	130 - 140	120 - 150	2
- Christmas	140 - 150	130 - 140	180 - 270	2
Fish	170 - 180	160 - 180	20 - 30	3
Fruit Pies, Crumbles	180 - 200	170 - 180	30 - 50	3
Milk Puddings	150 - 170	140 - 160	60 - 90	3
Pastry:				
- Choux	180 - 190	180 - 190	30 - 40	3
- Shortcrust	190 - 200	180 - 190	25 - 35	3
- Flaky	190 - 210	180 - 190	30 - 40	3
- Puff	Follow manufacturer's instructions. Reduce the temperature by 20°C for True Fan Cooking Function.			
Plate Tarts	190 - 200	180 - 190	25 - 45	3
Quiches / Flans	200 - 210	170 - 180	25 - 45	3
Scones	220 - 230	210 - 230	8 - 12	2

10.5 Slow Cooking

Use this function to prepare lean, tender pieces of meat and fish. This function is not applicable to such recipes as pot roast or fatty roast pork.

In the first 10 minutes you can set an oven temperature between 80 °C and 150 °C. The default is 90 °C. After the temperature is set, the oven continues to cook at 80 °C. Do not use this function for poultry.



Always cook without a lid when you use this function.

1. Sear the meat in a pan on the hob on a very high setting for 1 - 2 minutes on each side.
2. Put the meat together with the hot roasting pan into the oven on the wire shelf.
3. Select the function Slow Cooking.

Food	Quantity	Temperature (°C)	Time (min)	Shelf position
Roast beef	1000 - 1500 g	120	120 - 150	1

Food	Quantity	Temperature (°C)	Time (min)	Shelf position
Fillet of beef	1000 - 1500 g	120	90 - 150	3
Roast veal	1000 - 1500 g	120	120 - 150	1
Steaks	200 - 300 g	120	20 - 40	3

10.6 Pizza Setting

Top oven

Food	Temperature (°C)	Time (min)	Shelf position
Apple Pie	160 - 180	160 - 180	1
Plate Tart	160 - 180	25 - 50	1
Pizza	Follow manufacturer's instructions.		1
Quiches / Tarts	160 - 180	25 - 50	1

Main oven

Food	Temperature (°C)	Time (min)	Shelf position
Apple Pie	160 - 180	50 - 60	3
Plate Tart	180 - 200	25 - 50	3
Pizza	Follow manufacturer's instructions.		3
Quiches / Tarts	180 - 200	25 - 50	3

10.7 Roasting

- Use heat-resistant ovenware to roast (refer to the instructions of the manufacturer).
- You can roast large roasting joints directly in the deep pan (if present) or on the wire shelf above the deep pan.
- Roast lean meats in the roasting tin with the lid. This keeps the meat more succulent.
- All types of meat that can be browned or have crackling can be roasted in the roasting tin without the lid.
- We recommend that you cook meat and fish weighing 1 kg and above in the appliance.
- To prevent the meat juices or fat from burning onto the pan, put some liquid into the deep pan.
- If necessary, turn the roast (after 1/2 - 2/3 of the cooking time).
- Baste large roasts and poultry with their juices several times during roasting. This gives better roasting results.
- You can deactivate the appliance approximately 10 minutes before the end of the roasting time, and use the residual heat.

10.8 Roasting tables - Main oven

Beef

Food	Quantity	Temperature (°C)	Time (min)	Shelf position
Roast beef or fillet: rare	per cm. of thickness	190 - 200 ¹⁾	5 - 6	2
Roast beef or fillet: medium	per cm. of thickness	180 - 190 ¹⁾	6 - 8	2
Roast beef or fillet: well done	per cm. of thickness	170 - 180 ¹⁾	8 - 10	2

1) Preheat the oven.

Pork

Food	Quantity	Temperature (°C)	Time (min)	Shelf position
Shoulder, neck, ham	1 - 1.5 kg	160 - 180	90 - 120	2
Pork chop	1 - 1.5 kg	160 - 180	60 - 90	2
Meat loaf	750 g - 1 kg	160 - 170	45 - 60	2
Knuckle of pork (precooked)	750 g - 1 kg	150 - 170	90 - 120	2

Veal

Food	Quantity (kg)	Temperature (°C)	Time (min)	Shelf position
Roast veal	1	160 - 180	90 - 120	2
Knuckle of veal	1.5 - 2	160 - 180	120 - 150	2

Lamb

Food	Quantity (kg)	Temperature (°C)	Time (min)	Shelf position
Leg of lamb, roast lamb	1 - 1.5	150 - 170	75 - 120	2
Saddle of lamb	1 - 1.5	160 - 180	60 - 90	2

Game

Food	Quantity (kg)	Temperature (°C)	Time (min)	Shelf position
Saddle of hare, leg of hare	Up to 1 kg	220-250	25 - 40	2

Food	Quantity (kg)	Temperature (°C)	Time (min)	Shelf position
Loin of Game	1.5-2	210-220	75 - 105	1
Leg of Game	1.5-2	200-210	90 - 135	1

Poultry

Food	Quantity	Temperature (°C)	Time (min)	Shelf position
Poultry pieces	200 - 250 g each	200 - 220	35 - 50	3
Half chicken	400 - 500 g each	190 - 210	35 - 50	3
Poultry	1 - 1.5 kg	190 - 210	45 - 75	1
Duck	1.5 - 2 kg	180 - 200	75 - 100	1
Goose	3.5 - 5 kg	160 - 180	150 - 210	1
Turkey	2.5 - 3.5 kg	160 - 180	105 - 150	1
Turkey	4 - 6 kg	140 - 160	150 - 240	1

Fish (steamed)

Type of meat	Quantity (kg)	Temperature (°C)	Time (min)	Shelf position
Whole fish	1 - 1.5	210 - 220	40 - 60	1

10.9 Grilling

Always grill with the maximum temperature setting.

Set the shelf into the shelf position as recommended in the grilling table.

For grilling in the top oven adjust the shelf position to suit different thicknesses of food.

Always set the pan to collect the fat into the first shelf position.

Grill only flat pieces of meat or fish.

Always preheat the empty oven with the grill functions for 5 minutes.



CAUTION!

Always grill with the oven door closed.

Grilling and Fast Grilling - Top oven

Food	Time (min)
Bacon Rashers	5 - 6
Beefburgers	10 - 20
Chicken Joints	20 - 40
Lamb Chops	15 - 25

Food	Time (min)
Pork Chops	20 - 25
Whole Fish, Trout / Makarel	10 - 12
Filletts, Plaice / Cod	4 - 6
Kebabs	12 - 18
Kidneys, Lamb / Pig	6 - 10
Sausages	20 - 30
Toasted Sandwiches	3 - 4
Steaks:	
- Rare	4 - 6
- Medium	6 - 8
- Well Done	12 - 15

Grilling - Main oven

Food	Temperature (°C)	Time (min)		Shelf position
		1st side	2nd side	
Roast beef	210 - 230	30 - 40	30 - 40	2
Filet of beef	230	20 - 30	20 - 30	3
Back of pork	210 - 230	30 - 40	30 - 40	2
Back of veal	210 - 230	30 - 40	30 - 40	2
Back of lamb	210 - 230	25 - 35	20 - 25	3
Whole Fish, 500 - 1000 g	210 - 230	15 - 30	15 - 30	3 / 4

Fast Grilling - Main oven

Food	Time (min)		Shelf position
	1st side	2nd side	
Burgers / Burgers	8 - 10	6 - 8	4
Pork fillet	10 - 12	6 - 10	4
Sausages	10 - 12	6 - 8	4
Fillet / Veal steaks	7 - 10	6 - 8	4
Toast / Toast ¹⁾	1 - 3	1 - 3	5
Toast with topping	6 - 8	-	4

¹⁾ Preheat the oven.

10.10 Defrost - Main oven

Remove the food packaging and put the food on a plate.

Use the first shelf position from the bottom.

Do not cover the food with a bowl or a plate, as this can extend the defrost time.

Food	Quantity	Defrosting time (min)	Further defrosting time (min)	Comments
Chicken	1 kg	100 - 140	20 - 30	Put the chicken on an upturned saucer in a big plate. Turn halfway through.
Meat	1 kg	100 - 140	20 - 30	Turn halfway through.
Meat	500 g	90 - 120	20 - 30	Turn halfway through.
Trout	150 g	25 - 35	10 - 15	-
Strawberries	300 g	30 - 40	10 - 20	-
Butter	250 g	30 - 40	10 - 15	-
Cream	2 x 200 g	80 - 100	10 - 15	Whip the cream when still slightly frozen in places.
Gateau	1.4 kg	60	60	-

11. CARE AND CLEANING



WARNING!

Refer to Safety chapters.

11.1 Notes on cleaning

- Clean the front of the appliance with a soft cloth with warm water and a cleaning agent.
- To clean metal surfaces, use a usual cleaning agent.
- Clean the appliance interior after each use. Fat accumulation or other food remains may result in a fire. The risk is higher for the grill pan.
- Clean stubborn dirt with a special oven cleaner.
- Clean all accessories after each use and let them dry. Use a soft cloth with warm water and a cleaning agent.
- If you have nonstick accessories, do not clean them using aggressive agents, sharp-edged objects or a

dishwasher. It can cause damage to the nonstick coating.

11.2 Stainless steel or aluminium appliances



Clean the oven door with a wet sponge only. Dry it with a soft cloth. Do not use steel wool, acids or abrasive materials as they can damage the oven surface. Clean the oven control panel with the same precautions.

11.3 Removing the shelf supports

To clean the oven, remove the shelf supports.

1. Pull the front of the shelf support away from the side wall.

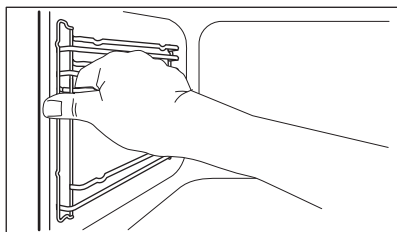

2. Pull the rear end of the shelf support away from the side wall and remove it.

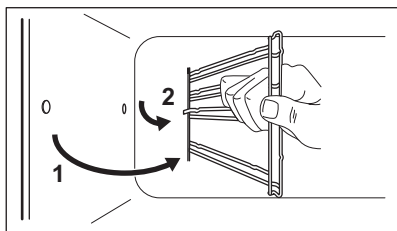

Install the shelf supports in the opposite sequence.

- i** The retaining pins on the telescopic runners must point to the front.

11.4 Catalytic cleaning

- !** **CAUTION!** Do not clean the catalytic surface with oven sprays, abrasive cleaning agents, soap or other cleaning agents. This will damage the catalytic surface.

- i** Spots or discolouration of the catalytic surface have no effect on catalytic properties.

- !** **WARNING!** Keep children away when you clean the oven at a high temperature. The oven surface becomes very hot and there is a risk of burns.

- !** **CAUTION!** Always turn the oven light on while using the catalytic cleaning (if applicable).

- i** Before activating the catalytic cleaning remove all the accessories from the oven.

The walls with a catalytic coating are self-cleaning. They absorb fat which collects on the walls while the appliance operates.

To support the self-cleaning procedure, heat the empty oven on a regular basis.

1. Clean the oven floor with warm water and washing up liquid, then dry it.
2. Set the CATA function. Oven will switch off after one hour.
3. When the appliance is cool, clean it with a soft and moist sponge.

11.5 Removing and installing the door

You can remove the door and the internal glass panels to clean it. The number of glass panels is different for different models.

- !** **WARNING!** Be careful when you remove the door from the appliance. The door is heavy.

1. Open the door fully.
2. Fully lift up the clamping levers (A) on the two door hinges.

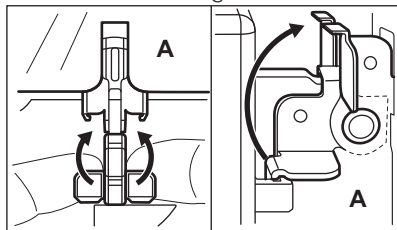

3. Close the door until it is at an angle of approximately 45°.

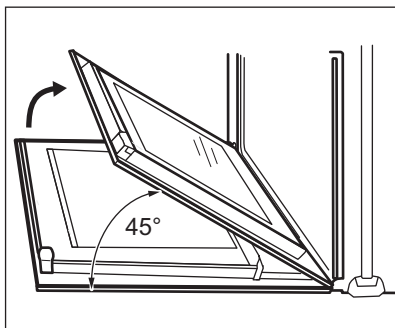

4. Hold the door with one hand on each side and pull it away from the appliance at an upwards angle.
5. Put the door with the outer side down on a soft cloth on a stable surface. This is to prevent scratches.
6. Hold the door trim (B) on the top edge of the door at the two sides and push inwards to release the clip seal.

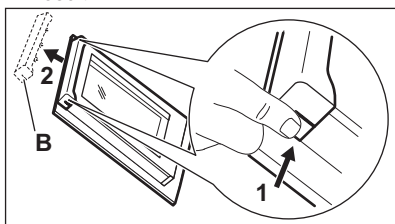
**CAUTION!**

Rough handling of the glass, especially around the edges of the front panel, can cause the glass to break.

7. Pull the door trim to the front to remove it.
8. Hold the door glass panels on their top edge one by one and pull them up out of the guide.

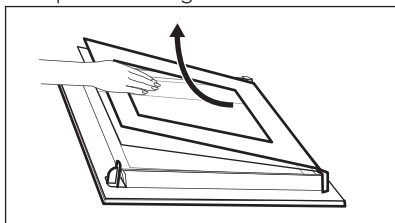

9. Clean the glass panel with water and soap. Dry the glass panel carefully.

When the cleaning is completed, install the glass panels and the door. Do the above steps in the opposite sequence. Install the smaller panel first, then the larger.

11.6 Replacing the lamp

Put a cloth on the bottom of the interior of the appliance. It prevents damage to the lamp glass cover and the cavity.

**WARNING!**

Danger of electrocution!
Disconnect the fuse before you replace the lamp. The lamp and the lamp glass cover can be hot.

1. Deactivate the appliance.
2. Remove the fuses from the fuse box or deactivate the circuit breaker.

The back lamp



The lamp glass cover is at the back of the cavity.

1. Turn the lamp glass cover counterclockwise to remove it.
2. Clean the glass cover.
3. Replace the oven lamp with a suitable 300 °C heat-resistant oven lamp.
Use the same oven lamp type.
4. Install the glass cover.

The side lamp

1. Remove the left shelf support to get access to the lamp.
2. Use a narrow, blunt object (e.g. a teaspoon) to remove the glass cover.

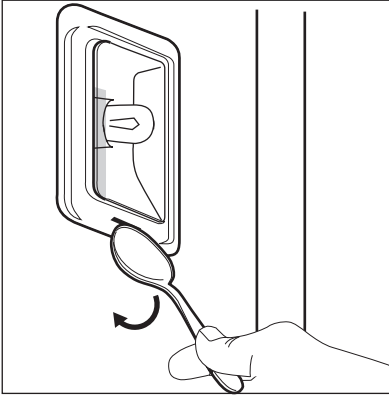

3. Clean the glass cover.
4. Replace the lamp with a suitable 300 °C heat-resistant lamp.
5. Install the glass cover.
6. Install the left shelf support.

12. TROUBLESHOOTING



WARNING!

Refer to Safety chapters.

12.1 What to do if...

Problem	Possible cause	Remedy
The oven does not heat up.	The oven is deactivated.	Activate the oven.
The oven does not heat up.	The clock is not set.	Set the clock.
The oven does not heat up.	The necessary settings are not set.	Make sure that the settings are correct.
The oven does not heat up.	The automatic switch-off is activated.	Refer to "Automatic switch-off".
The oven does not heat up.	The Child Lock is on.	Refer to "Using the Child Lock".
The oven does not heat up.	The fuse is released.	Make sure that the fuse is the cause of the malfunction. If the fuse releases again and again, contact a qualified electrician.
The lamp does not operate.	The lamp is defective.	Replace the lamp.
It takes too long to cook the dishes or they cook too quickly.	The temperature is too low or too high.	Adjust the temperature if necessary. Follow the advice in the user manual.

Problem	Possible cause	Remedy
Steam and condensation settle on the food and in the cavity of the oven.	You left the dish in the oven for too long.	Do not leave the dishes in the oven for longer than 15 - 20 minutes after the cooking process ends.
The display shows an error code that is not in this table.	There is an electrical fault.	<ul style="list-style-type: none"> Deactivate the oven with the house fuse or the safety switch in the fuse box and activate it again. If the display shows the error code again, contact the Customer Care Department.

12.2 Service data



If you cannot find a solution to the problem yourself, contact your dealer or an Authorised Service Centre.

The necessary data for the service centre is on the rating plate. The rating plate is

on the front frame of the appliance cavity. Do not remove the rating plate from the appliance cavity.

We recommend that you write the data here:	
Model (MOD.)
Product number (PNC)
Serial number (S.N.)

13. ENVIRONMENTAL CONCERNS

Recycle the materials with the symbol . Put the packaging in applicable containers to recycle it. Help protect the environment and human health and to recycle waste of electrical and electronic appliances. Do not dispose appliances marked with the symbol  with the household waste. Return the product to your local recycling facility or contact your municipal office.

www.aeg.com/shop



867300124-B-142014



 **AEG**
perfekt in form und funktion