



CONTENTS

1. SAFETY INFORMATION.....	3
2. SAFETY INSTRUCTIONS.....	5
3. PRODUCT DESCRIPTION.....	7
4. CONTROL PANEL.....	7
5. PROGRAMMES	8
6. CONSUMPTION VALUES.....	13
7. OPTIONS.....	13
8. SETTINGS.....	15
9. BEFORE FIRST USE.....	15
10. DAILY USE - WASHING ONLY.....	15
11. DAILY USE - DRYING ONLY.....	19
12. DAILY USE - WASHING & DRYING.....	20
13. HINTS AND TIPS.....	22
14. CARE AND CLEANING.....	24
15. TROUBLESHOOTING.....	28
16. EMERGENCY DOOR OPENING.....	30
17. TECHNICAL DATA.....	31

WE'RE THINKING OF YOU

Thank you for purchasing an Electrolux appliance. You've chosen a product that brings with it decades of professional experience and innovation. Ingenious and stylish, it has been designed with you in mind. So whenever you use it, you can be safe in the knowledge that you'll get great results every time.

Welcome to Electrolux.

Visit our website for:



Get usage advice, brochures, trouble shooter, service information:

www.electrolux.com



Register your product for better service:

www.registerelectrolux.com



Buy Accessories, Consumables and Original spare parts for your appliance:

www.electrolux.com/shop

CUSTOMER CARE AND SERVICE

Always use original spare parts.

When contacting our Authorised Service Centre, ensure that you have the following data available: Model, PNC, Serial Number.

The information can be found on the rating plate.



Warning / Caution-Safety information



General information and tips



Environmental information

Subject to change without notice.

1. SAFETY INFORMATION

Before the installation and use of the appliance, carefully read the supplied instructions. The manufacturer is not responsible if an incorrect installation and use causes injuries and damages. Always keep the instructions with the appliance for future reference.

1.1 Children and vulnerable people safety



WARNING!

Risk of suffocation, injury or permanent disability.

- This appliance can be used by children aged from 8 years and above and persons with reduced physical, sensory or mental capabilities or lack of experience and knowledge if they have been given supervision or instruction concerning use of the appliance in a safe way and understand the hazards involved.
- Do not let children play with the appliance.
- Children of less than 3 years should be kept away unless continuously supervised.
- Keep all packaging away from children.
- Keep all detergents away from children.
- Keep children and pets away from the appliance door when it is open.
- Cleaning and user maintenance shall not be made by children without supervision.

1.2 General Safety

- Do not change the specification of this appliance.
- The appliance can be installed as freestanding or below the kitchen counter with correct space.
- Do not install the appliance behind a lockable door, a sliding door or a door with a hinge on the opposite side, where the appliance door can not be fully opened.

- Connect the mains plug to the mains socket only at the end of the installation. Make sure that there is access to the mains plug after the installation.
- The ventilation openings in the base (if applicable) must not be obstructed by a carpet.
- Ensure you have good ventilation in the installation room to avoid the back flow of gases into the room from appliances burning other fuels, including open fires.
- Exhaust air must not be discharged into a flue which is used for exhausting fumes from appliances burning gas or other fuels (if applicable).
- The operating water pressure (minimum and maximum) must be between 0,5 bar (0,05 MPa) and 8 bar (0,8 MPa).
- Obey the maximum load volume of 8 kg (refer to the “Programme chart” chapter).
- The appliance is to be connected to the water mains using the new supplied hose-sets. Old hose sets must not be reused.
- If the supply cord is damaged, it must be replaced by the manufacturer, its Authorised Service Centre or similarly qualified persons in order to avoid a hazard.
- Wipe away lint that has accumulated around the appliance.
- Items that have been soiled with substances such as cooking oil, acetone, alcohol, petrol, kerosene, spot removers, turpentine, waxes and wax removers should be washed in hot water with an extra amount of detergent before being dried in the wash dryer.
- Do not use the appliance if industrial chemicals have been used for cleaning.
- Do not dry unwashed items in the wash dryer.
- Items such as foam rubber (latex foam), shower caps, waterproof textiles, rubber backed articles and clothes or pillows fitted with foam rubber pads should not be dried in the wash dryer.

- Fabric softeners, or similar products, should be used as specified by the fabric softener instructions.
- Remove all objects from pockets such as lighters and matches.
- Never stop the wash dryer before the end of the drying cycle unless all items are quickly removed and spread out so that the heat is dissipated.
- The final part of a wash dryer cycle occurs without heat (cool down cycle) to ensure that the items are left at a temperature that ensures that the items will not be damaged.
- Do not use water spray and steam to clean the appliance.
- Clean the appliance with a moist soft cloth. Only use neutral detergents. Do not use abrasive products, abrasive cleaning pads, solvents or metal objects.
- Before maintenance, deactivate the appliance and disconnect the mains plug from the mains socket.

2. SAFETY INSTRUCTIONS

2.1 Installation

- Obey the installation instruction supplied with the appliance.
- Do not install or use the appliance where the temperature is less than 0 °C or where it is exposed to the weather.
- Always move the appliance vertically.
- Make sure that there is air circulation between the appliance and the floor.
- Remove all the packaging and the transit bolts.
- Make sure that the floor where you install the appliance is flat, stable, heat resistant and clean.
- Keep the transit bolts. When you move the appliance again you must block the drum.
- Always be careful when you move the appliance because it is heavy. Always wear safety gloves.
- Do not install or use a damaged appliance.

- Do not install or use the appliance where the temperature is less than 0 °C or where it is exposed to the weather.
- Do not install the appliance where the appliance door can not be fully opened.
- Adjust the feet to have the necessary space between the appliance and the carpet.
- When the appliance is put in its permanent position, check if it is fully level with the aid of a spirit level. If it is not, adjust the feet until it is.

2.2 Electrical Connection



WARNING!

Risk of fire and electrical shock.

- The appliance must be earthed.
- Always use a correctly installed shockproof socket.

- Do not use multi-plug adapters and extension cables.
- Do not pull the mains cable to disconnect the appliance. Always pull the mains plug.
- Do not touch the mains cable or the mains plug with wet hands.
- Only for UK and Ireland: The appliance has a 13 amp mains plug. If it is necessary to change the fuse in the mains plug, use a 13 amp ASTA (BS 1362) fuse.
- This appliance complies with the E.E.C. Directives.
- Do not touch the glass of the door while a programme operates. The glass can be hot.
- Do not dry the damaged items which contain padding or fillings.
- If you have washed your laundry with a stain remover start an extra rinse cycle before you start a drying cycle.
- Make sure that you remove all metal objects from the laundry.
- Only dry fabrics which are applicable to dry in the washer-dryer. Follow the instructions on the fabric label.
- Plastic items are not heat resistant.
 - If you use a detergent ball, remove it before you set the drying programme.
 - Do not use a detergent ball when you set a non-stop programme.

2.3 Water Connection

- Make sure not to cause damage to the water hoses.
- Before you connect the appliance to new pipes or pipes not used for a long time, let the water flow until it is clean.
- The first time you use the appliance, make sure that there is no leakage.

2.4 Use



WARNING!

Risk of injury, electrical shock, fire, burns or damage to the appliance.

- Use this appliance in a household only.
- Do not change the specification of this appliance.
- Do not put flammable products or items that are wet with flammable products in, near or on the appliance.



WARNING!

Risk of injury or damage to the appliance.

- Do not sit or stand on the open door.
- Do not dry dripping wet clothes in the appliance.

2.5 Disposal

- Disconnect the appliance from the mains supply.
- Cut off the mains cable and discard it.
- Remove the door catch to prevent children and pets to get closed in the appliance.

3. PRODUCT DESCRIPTION

3.1 Appliance overview

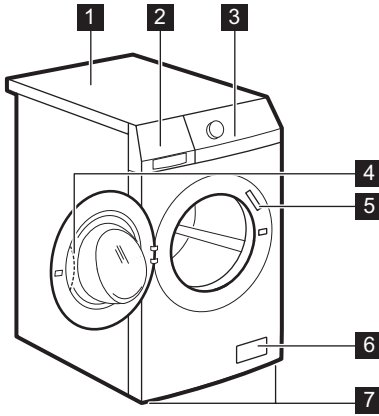

- 1** Worktop
- 2** Detergent dispenser
- 3** Control panel
- 4** Door handle
- 5** Rating plate
- 6** Drain pump filter
- 7** Feet for the appliance level

3.2 Fixing plate kit (4055171146)

Available from your authorized dealer.
If you install the appliance on a plinth, secure the appliance in the fixing plates.



Read carefully the instructions supplied with the accessory.



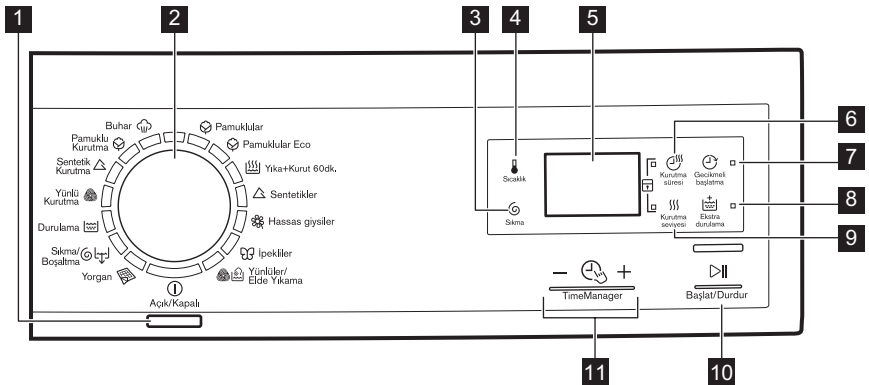

4. CONTROL PANEL

4.1 Control panel description











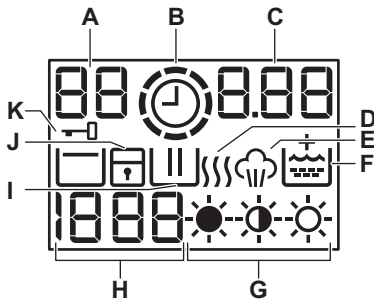

- 1** On Off button (Açık/Kapalı)
- 2** Programme knob
- 3** Spin reduction touchpad (Sıkma)
- 4** Temperature touchpad (Sıcaklık)

- 5 Display
- 6 Drying time touchpad  (Kurutma süresi)
- 7 Delay start touchpad  (Gecikmeli başlatma)
- 8 Extra rinse touchpad  (Ekstra durulama)

- 9 Drying level touchpad  (Kurutma seviyesi)
- 10 Start/Pause touchpad  (Başlat/Durdur)
- 11 Time Manager touchpads -  +  (Time Manager)

4.2 Display

















- A) The Temperature area:
 - 88: Temperature indicator
 - : Cold water indicator
- B) : Time Manager indicator.
- C) The time area:
 - 1.25: the programme duration
 - 2h: the delay start
 - E20: the alarm codes
 - Err: the message of error
 - 0: the programme is completed.
- D) : The drying phase.
- E) : The steam phase.
- F) : The Extra rinse permanent option.
- G) : The indicators of dryness level.
- H) The spin area:
 - 1888: the Spin speed indicator
 - : the No Spin indicator
 - : the Rinse Hold indicator
- I) : The washing phase.
- J) : The child safety lock indicator.
- K) : The door locked indicator

5. PROGRAMMES

5.1 Programme Chart

Programme Temperature range	Maximum load Maximum spin speed	Programme description (Type of load and soil level)
Washing programmes		

Programme Temperature range	Maximum load Maximum spin speed	Programme description (Type of load and soil level)
 Pamuklular 90°C - Cold	8 kg 1600 rpm	White cotton and coloured cotton. Normal soil and light soil.
 Pamuklular Eco ¹⁾ 60°C - 40°C	8 kg 1600 rpm	White cotton and colour-fast cotton. Normal soil. The energy consumption decreases and the time of the washing programme is extended.
 Yıka+Kurut 60dk. 40°C - 30°C	1 kg 1200 rpm	Complete programme composed of washing phase and of drying phase for a small load size of mixed fabrics (cottons and synthetics items).
 Sentetikler 60°C - Cold	3.5 kg 1200 rpm	Synthetic items or mixed fabric items. Normal soil.
 Hassas giysiler 40°C - Cold	3.5 kg 1200 rpm	Delicate fabrics as acrylics, viscose, polyester items. Normal soil.
 İpekliler 30°C	1 kg 1000 rpm	Special programme for silk and mixed synthetic items.
 Yünlüler/Elde yıkama 40°C - Cold	1.5 kg 1200 rpm	Machine washable wool, hand washable wool and delicate fabrics with «hand washing» care symbol. ²⁾
 Yorgan 60°C - Cold	2.5 kg 800 rpm	Special programme for one synthetic blanket, duvet, bedspread and so on.
 Sıkma/Boşaltma ³⁾	8 kg 1600 rpm	To spin the laundry and to drain the water in the drum. All fabrics.
 Durulama Cold	8 kg 1600 rpm	To rinse and spin the laundry. All fabrics.
Drying programmes)))		
 Yünlü Kurutma	1 kg	Drying programme for woollen.

Programme Temperature range	Maximum load Maximum spin speed	Programme description (Type of load and soil level)
 Sentetik Kurutma	2 kg	Drying programme for synthetic items .
 Pamuklu Kurutma	4 kg	Drying programme for cotton items .
Steam programmes⁴⁾		
<p>Steam can be used for dried, washed or worn once laundry. These programmes can reduce creases and odours and make your laundry more soft.</p> <p>Do not use any detergent. If necessary, remove stains by washing or using localized stain removal.</p> <p>Steam programmes do not perform any hygienic cycle.</p> <p>Do not set a Steam programme with these types of items:</p> <ul style="list-style-type: none"> • items where it is not specified on the care label as being suitable for tumble drying. • all items with plastic, metal, wooden parts or alike. 		
 Buhar 40°C	1.5 kg	Steam programme for cotton and synthetic items . This cycle helps to dewrinkle the laundry.









1) Cottons energy saving programme. This programme at a 60°C with a load of 8 is the reference programme for data entered in the energy label, in compliance with EEC 92/75 standards. Set this programme to have a good washing results and decrease the energy consumption. The time of the washing programme is extended.















2) During this cycle the drum rotates slowly to ensure a gentle washing. It can seem that the drum doesn't rotate or doesn't rotate properly. Consider this as a normal functioning of the appliance.

3) Set the spin speed. Make sure it agrees with the laundry. If you set No Spin option the only drain phase is available.

4) If you set a Steam programme with dried laundry, at the end of the cycle the laundry could be humid. It is better to expose the items to the fresh air for about 10 minutes to let the humidity dry. When the programme is completed, quickly remove the laundry from the drum. After a steam cycle, items may to be ironed anyway, but with less effort!



Programme options compatibility

Programme					
Pamuklular 	■	■	■	■	■
Pamuklular Eco 	■	■	■	■	■
Yıka+Kurut 60dk. 				■	

Programme					
Sentetikler 	■	■	■	■	■
Hassas giysiler 	■	■	■	■	■
İpekliler 	■	■		■	
Yünlüler/Elde yıkama  	■	■	■	■	
Yorgan 	■			■	
Sıkma/Boşaltma   1)	■	■		■	
Durulama 	■	■	■	■	■

1) Set the spin speed. Make sure it agrees with the laundry. If you set No Spin option the only drain phase is available.

5.2 Automatic drying

Dryness Level	Type of fabric	Load
 Extra Dry For towelling materials	Cottons and Linen (bathrobes, bath towels, etc)	up to 4 kg
 Cupboard Dry ¹⁾ For items to put away	Cottons and Linen (bathrobes, bath towels, etc)	up to 4 kg
	Synthetics and mixed fabrics (jumpers, blouses, underwear, household linen)	up to 2 kg
	Silk items (blouse, shirt, clothing..)	up to 1 kg
	Wool items (woolen jumper)	up to 1 kg
 Iron Dry Suitable for ironing	Cottons and Linen (sheets, tablecloths, shirts, etc)	up to 4 kg

1) **Hints for test institute** The test performance, in accordance with EN 50229, must be carried out with a FIRST drying load of the maximum declared drying capacity (load composition according to EN61121) by setting the AUTOMATIC CUPBOARD DRY programme for Cotton. The SECOND drying load with the residual load must be tested by setting the AUTOMATIC CUPBOARD DRY programme for Cotton.

5.3 Timed drying

Dryness Level	Type of fabric	Load (kg)	Spin speed (rpm)	Suggested duration (mins)
Extra Dry For towelling materials	Cottons and Linen (bathrobes, bath towels, etc)	4	1600	165 - 180
		2	1600	90 - 100
		1	1600	60 - 70
Cupboard Dry For items to put away	Cottons and Linen (bathrobes, bath towels, etc)	4	1600	155 - 170
		2	1600	80 - 90
		1	1600	50 - 60
Cupboard Dry For items to put away	Synthetics and mixed fabrics (jumpers, blouses, underwear, household linen)	2	1200	90 - 105
		1	1200	40 - 50
	Wool (wool jumpers)	1	1200	80 - 100
	Silk (blouses, shirts, clothes etc)	1	1000	80
Iron Dry Suitable for ironing	Cottons and Linen (sheets, tablecloths, shirts, etc)	4	1600	110 - 125
		2	1600	65 - 75
		1	1600	40 - 50

5.4 Woolmark Apparel Care - Blue



- The wool wash cycle of this machine has been approved by The Woolmark Company for the washing of wool garments labelled as «hand wash» provided that the garments are

washed according to the instructions issued by the manufacturer of this washing machine. Follow the garment care label for drying and other laundry instructions. M1380

- The wool drying cycle of this machine has been approved by The Woolmark Company for the drying of wool garments labelled as «hand wash» provided that the garments are dried according to the instructions issued by the manufacturer of this machine. Follow the garment care label for other laundry instructions. M1381

In UK, Eire, Hong Kong and India the Woolmark symbol is a certification trademark.

6. CONSUMPTION VALUES



The data of this table are approximate. Different causes can change the data: the quantity and type of laundry, the water and ambient temperature.



At programme start the display shows the duration programme for the maximum load capacity.
During the washing phase the programme duration is automatically calculated and can be greatly reduced if the laundry load is lower than the maximum load capacity (e.g. Cotton 60°C, maximum load capacity 8 kg, the programme duration exceeds 2 hours; real load 1 kg, the programme duration don't reach 1 hour).
When the appliance is calculating the real programme duration a dot blinks in the display.

Programmes	Load (kg)	Energy consumption (kWh)	Water consumption (litre)	Approximate programme duration (minutes)
Cottons 60 °C	8	1.35	67	175
Pamuklular Eco Cotton Energy Saving Programme 60 °C ¹⁾	8	1.07	63	241
Cottons 40 °C	8	0.85	67	170
Synthetics 40 °C	3.5	0.40	48	115
Delicates 40 °C	3.5	0.50	55	80
Wool/Handwash 30 °C	1.5	0.25	45	60

¹⁾ «Cotton Energy Saving programme » at 60°C with a load of 8 kg is the reference programme for the data entered in the energy label, in compliance with EEC 92/75 standards.

7. OPTIONS

7.1 Sıcaklık

Set this option to change the default temperature.

Indicator — — = cold water.

The display shows the set temperature.

7.2 Sıkma

With this option you can decrease the default spin speed.

The display shows the indicator of the set speed.

Additional spin options:

No Spin

- Set this option to remove all spin phases.
- Set it for very delicate fabrics.
- The rinse phase uses more water for some washing programmes.
- The display shows the indicator

— — — .

Rinse Hold

- Set this option to prevent the laundry creases.
- The washing programme stops with the water in the drum. The drum turns regularly to prevent the laundry creases.
- The door stays locked. You must drain the water to unlock the door.
- The display shows the indicator .



To drain the water refer to 'At the end of the programme'.

7.3 Kurutma süresi

With this option you can set the time for the fabrics you have to dry. The display shows the set value.

Each time you press this touchpad the time value increases by 5 minutes.



You cannot set all time values for different types of fabrics.

7.4 Gecikmeli başlatma

With this option you can delay the start of a programme from 30 minutes to 20 hours.

The display shows the related indicator.

7.5 Ekstra durulama



With this option you can add some rinses to a washing programme.

Use this option for persons allergic to detergents and in areas where the water is soft.

The related indicator comes on.



7.6 Kurutma seviyesi

With this option you can set an automatic level of dryness for the laundry. The display shows the symbol of the set level.













-  **Extra dry** level for cotton items
-  **Cupboard dry** level for cotton, synthetic, silk and wool items
-  **Iron dry** level for cotton items

7.7 Time Manager +

When you set a washing programme, the display shows the default duration.

Press  or  to decrease or increase the programme duration.

The Time Manager is available only with the programmes in the table.

Indicator				Pamuklular Eco	 1)	 1)
 2)	■	■		■		
	■	■	■		■	■
	■	■			■	
	■	■	■	■	■	■
	■	■			■	
	■ 3)	■ 3)	■		■ 3)	■
	■	■			■	
 4)	■	■	■ 3)	■ 3)	■	■ 3)

1) If available.

2) Shortest: to fresh the laundry.



3) Programme default duration.

4) Longest: Increasing the programme duration gradually decreases the energy consumption. The optimized heating phase saves energy and the longer duration maintains the same washing results (specially for normal soil).



8. SETTINGS

8.1 Child Lock

With this option you can prevent that the children play with the control panel.



- To **activate/deactivate** this option, press  and  at the same time until the indicator  **comes on/goes off**.

You can activate this option:

- After you press : the options and the programme knob are locked.
- Before you press : the appliance cannot start.

8.2 Permanent Extra Rinse



With this option you can permanently have an extra rinse when you set a new programme.

- To **activate/deactivate** this option press  and  at the same time until the indicator  **comes on/goes off**.

8.3 Acoustic signals

The acoustic signals operate when:

- The programme is completed.
- The appliance has a malfunction.

To **deactivate/activate** the acoustic signals, press  and  at the same time for 6 seconds.



If you deactivate the acoustic signals, they continue operate when the appliance has a malfunction.

9. BEFORE FIRST USE

1. Put 2 litre of water in the detergent compartment for washing phase. This activates the drain system.
2. Put a small quantity of detergent in the compartment for washing phase.
3. Set and start a programme for cotton at the highest temperature without laundry. This removes all possible dirt from the drum and the tub.

10. DAILY USE - WASHING ONLY

10.1 Loading the laundry

1. Open the appliance door
2. Put the laundry in the drum, one item at a time.
3. Shake the items before you put them in the appliance.
Make sure not to put too much laundry in the drum.
4. Close the door firmly.

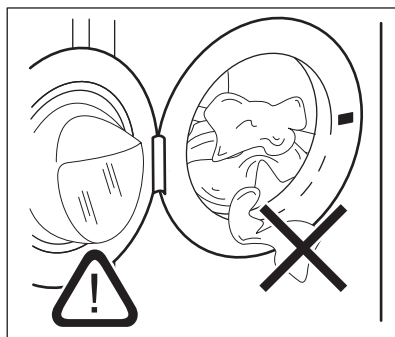

CAUTION!

Make sure that no laundry stays between the seal and the door. There is a risk of water leakage or damage to the laundry.

10.2 Using detergent and additives

1. Measure out the detergent and the fabric conditioner.
2. Put the detergent and the fabric conditioner into the compartments.
3. Carefully close the detergent drawer.

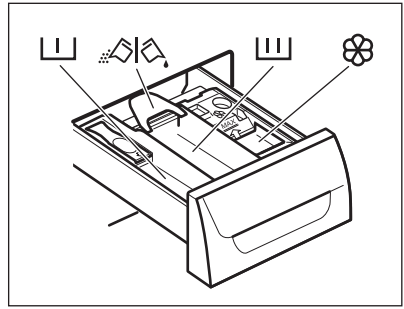

10.3 Detergent compartments







CAUTION!

Use only specified detergents for washing machine.



Always obey the instructions that you find on the packaging of the detergent products.

	Detergent compartment for prewash phase.
	Detergent compartment for washing phase.
	Compartment for liquid additives (fabric conditioner, starch).
	Flap for powder or liquid detergent.

10.4 Liquid or powder detergent

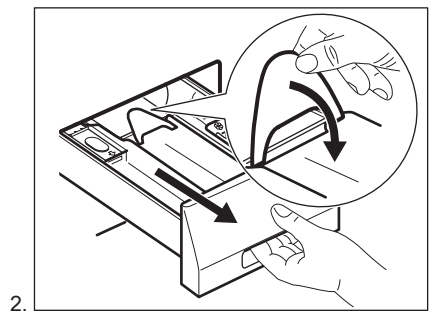
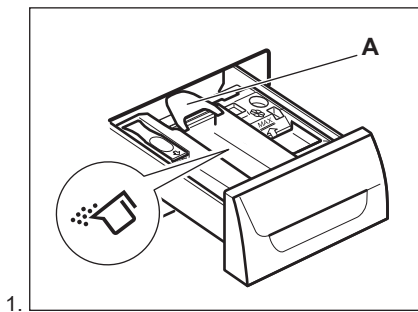

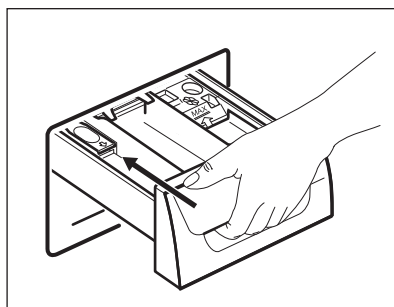
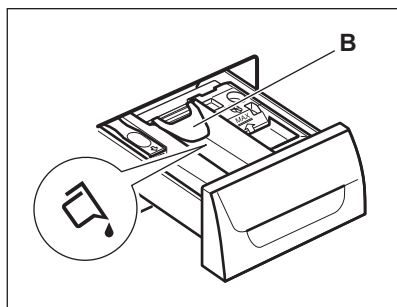

- 3.
- Position **A** for powder detergent (factory setting).
 - Position **B** for liquid detergent.



When you use the liquid detergent:

- Do not use gelatinous or thick liquid detergents.
- Do not put more liquid than the maximum level.
- Do not set the prewash phase.
- Do not set the delay start.

10.5 Activating the appliance

Press the  button to activate or deactivate the appliance. A tune sounds when the appliance is activated.

10.6 Setting a programme



1. Turn the programme knob and set the programme:
 - The related programme indicator comes on.
 - The indicator of the  flashes.
 - The display shows the level of the Time Manager, the programme duration and the indicators of the programme phases.
2. If necessary, change the temperature, the spin speed, the cycle duration or add available options. When you activate an option, the indicator of the set option comes on.



If you set something incorrect, the display shows the message .

10.7 Starting a programme without the delay start

Press .

- The indicator of  stops to flash and stays on.
- The indicator  starts to flash on the display.
- The programme starts, the door locks, the display shows the indicator .
- The drain pump can operate for a short time when the appliance fills water.





After approximately 15 minutes from the start of the programme:

- The appliance adjusts automatically the programme duration agree with the laundry load.
- The display shows the new value.

10.8 Starting a programme with the delay start





1. Press  again and again until the display shows the delay you want to set.

The related indicator comes on the display.

2. Press :
 - The appliance starts the countdown.
 - The door locks, the display shows the indicator .
 - When the countdown is completed, the programme starts automatically.





You can cancel or change the set of the delay start before you press the . To cancel the delay start:

- Press  to set the appliance to pause.
- Press  until the display shows .
- Press  again to start the programme immediately.

10.9 Interrupting a programme and changing the options

You can change only some options before they operate.

1. Press .
The indicator flashes.
2. Change the options.
3. Press  again.
The programme continues.

10.10 Cancelling a running programme

1. Press the button  for some seconds to cancel the programme and to deactivate the appliance.
2. Press the same button again to activate the appliance. Now, you can set a new washing programme.



Before starting the new programme the appliance could drain the water. In this case, make sure that the detergent is still in the detergent compartment, if not fill the detergent again.

10.11 Opening the door





CAUTION!





If the temperature and level of the water in the drum are too high and the drum still rotates, you cannot open the door.

While a programme or the delay start operates, the appliance door is locked and the display shows the indicator .

Open the appliance door when the programme or the delay start operates:

1. Press  to pause the appliance.
2. Wait until the door lock indicator  goes off.
3. Open the door.
4. Close the door and press again . The programme or delay start continues to operate.





10.12 At the end of the programme

- The appliance stops automatically.
- The acoustic signal operates (if it is activated).
- In the display  comes on.
- The indicator of the  goes off.
- The door lock indicator  goes off.
- You can open the door.
- Remove the laundry from the appliance. Make sure that the drum is empty.
- Close the water tap.
- Press the button  for some seconds to deactivate the appliance.
- Keep the door ajar, to prevent the mildew and odours.

The washing programme is completed, but there is water in the drum:

- The drum turns regularly to prevent the creases in the laundry.
- The door lock indicator  is on. The door stays locked.
- You must drain the water to open the door.



To drain the water:

1. Press . The appliance drains the water and spins.
2. To make the appliance drain only, set . If necessary, decrease the spin speed.
3. When the programme is completed, and the door lock indicator  goes off, you can open the door.
4. Press the button  for some seconds to deactivate the appliance.

 The appliance drains and spins automatically after approximately 18 hours (except for Wool programme).

10.13 AUTO Stand-by option

The AUTO Stand-by function automatically deactivates the appliance to decrease the energy consumption when:

- You do not use the appliance for 5 minutes before you press . Press the button  to activate the appliance again.
- After 5 minutes from the end of the washing programme Press the button  to activate the appliance again. The display shows the end of the last set programme. Turn the programme knob to set a new cycle.

 If you set a programme or an option that ends with water in the drum, the AUTO Stand-by function **doesn't deactivate** the appliance to remind you to drain the water.

11. DAILY USE - DRYING ONLY

 **WARNING!**
Refer to Safety chapters.

11.1 Drying setting



 **WARNING!**
Make sure that the water tap is open.



1. Press Açık/Kapalı for some seconds to activate the appliance.
2. Load the laundry one item at a time.
3. Turn the programme dial to the programme applicable for the items to dry. The display shows the drying indicator .

 To have a good drying performance **do not** exceed the maximum drying loads recommended in the user manual. **Do not** set a spin speed lower than the automatic speed of the set programme.



11.2 Drying at automatic levels

The laundry can be dried at pre-defined levels of dryness:

1. Press  again and again until the display shows one of the dryness level indicator:
 - : IRON DRY level indicator for cotton items

-  CUPBOARD DRY level indicator for cotton, synthetic, silk and wool items
-  EXTRA DRY level indicator for cotton items

The display shows a time value, calculated on the default load size. If the amount of your laundry is more or less than the default size, the appliance adjusts automatically the time value during the cycle.



2. Press  to start the programme. The display shows the door locked indicator . The drying indicator  starts to flash.





You cannot set all dryness levels for any type of laundry.

11.3 Timed drying

The laundry can also be dried with a manual timed drying:

1. Press  again and again to set the time value (see the «Programmes for timed drying» table).
 - The display shows 10 minutes. Each time you press this touchpad the time value increases by 5 minutes.
 - The display shows the set time value: for example – 40.
 - After some seconds the display shows a new time value: 43. The appliance calculates also the duration of the anti-crease and the cooling phases.
2. Press  to start the programme.



- The display shows regularly a new time value.
- The drying indicator  starts to flash.
- The display shows the door locked indicator .





If you set only 10 minutes of drying, the appliance performs only a cooling phase. If the laundry is not sufficient dry, set again a short drying time.

11.4 End of the drying programme

The appliance stops automatically.

- The acoustic signals operate (if they are active).
- In the display  comes on.
- The indicator  goes off.
- The last minutes of the drying cycle the appliance performs a cooling and anti-crease phase. The door is still locked.

When the door locked  goes off in the display, you can open the door.

1. Press the button  for some seconds to deactivate the appliance. After some minutes from the end of the programme, the energy saving function automatically deactivates the appliance.
2. Remove the laundry from the appliance. Make sure that the drum is empty.
3. Keep the door ajar, to prevent mildew and odours.
4. Close the water tap.

12. DAILY USE - WASHING & DRYING



WARNING!
Refer to Safety chapters.



12.1 Non-Stop programme

1. Press Açık/Kapalı for some seconds to activate the appliance.

2. Load the laundry one item at a time.

- i** To have a good drying performance **do not** exceed the maximum drying loads recommended in the user manual. **Do not** set a spin speed lower than the automatic speed of the set programme.
- Put the detergent and the additives in the appropriate compartment.
 - Turn the programme dial to the washing programme.
- The display shows the indicators of the different washing phases.
- Set the available options.

12.2 Washing & Automatic drying

- Press **|||** again and again until the display shows one of the dryness level indicator:
 - : IRON DRY level indicator for cotton items
 - : CUPBOARD DRY level indicator for cotton, synthetic, wool and silk items
 - : EXTRA DRY level indicator for cotton items

The display shows the indicator **|||**. The time value on the display is the duration of the washing + drying cycles, calculated on a default load size.

- i** To have a good drying the appliance does not let you set a too low spin speed for the items to be washed and dried.
- Press **▷|||** to start the programme. In the display the indicator of the set dryness level stays on.
- The door locked indicator **⏻** goes on. The display shows regularly a new time value.

- i** The last minutes of the drying cycle the appliance performs the anti-crease and the cooling phases.

12.3 Washing & Timed Drying

To have a good drying the appliance does not let you set a too low spin speed for the items to be washed and dried.

- Press **⌚** to set the drying time value. The display shows 10 minutes.

The indicator **|||** comes on in the display. The display shows the set drying value time. for example: **40**. After some seconds the display shows the final time value **203**, that is the total duration of the washing and drying cycles (washing + drying + anti-crease + cooling phases).

- i** If you set only 10 minutes of drying after washing, the appliance calculates also the duration of the anti-crease and the cooling phases.
- Press **▷|||** to start the programme.

In the display the indicator **⏻** comes on. The door is locked. The display shows regularly a new time value.

12.4 End of the programme

The appliance stops automatically. The acoustic signals operate (if they are active).

For more information see 'At the end of the drying programme' of the previous chapter.

- Remove the laundry from the appliance. Make sure that the drum is empty.
- Keep the door ajar, to prevent mildew and odours.
- Close the water tap.

12.5 Fluff in the fabrics

During the washing and/or drying phase, some types of fabric, (sponge, wool, sweatshirt) could release fluff.

The released fluff could stick to the fabrics during the next cycle.



This inconvenient increases with technical fabrics.

To prevent the fluff in your laundry, we recommend that you:

- To do not wash dark fabrics after you washed and dried light coloured fabrics (new sponge, wool, sweatshirt) and the contrary.
- To dry this type of fabrics at open air when they are washed the first time.
- To clean the drain filter.
- After the drying phase, clean the empty drum, the gasket and the door with a wet cloth.

12.6 How to remove the fluff in the garments

To remove the fluff inside the drum, set a special programme:

1. Empty the drum.
2. Clean the drum, the gasket and the door with a wet cloth.
3. Set the rinse programme.
4. Press at the same time  and  to activate the cleaning function until the display shows **CLE**.
5. Press  to start the programme.

13. HINTS AND TIPS



WARNING!
Refer to Safety chapters.

13.1 The laundry load

- Divide the laundry in: white, coloured, synthetics, delicates and wool.
- Obey the washing instructions that are on the laundry care labels.
- Do not wash together white and coloured items.
- Some coloured items can discolour with the first wash. We recommend that you wash them separately for the first times.
- Button up pillowcases, close zippers, hooks and poppers. Tie up belts.
- Empty the pockets and unfold the items.
- Turn inside out multilayered fabrics, wool and items with painted illustrations.
- Remove hard stains.
- Wash with a special detergent heavy soil stains.
- Be careful with the curtains. Remove the hooks or put the curtains in a washing bag or pillowcase.
- Do not wash in the appliance laundry without hems or with cuts. Use a washing bag to wash small and/or delicate items (e.g. underwired bras, belts, tights, etc.).
- A very small load can cause balance problems with the spin phase. If this

occurs, adjust manually the items in the tub and start the spin phase again.

13.2 Stubborn stains

For some stains, water and detergent is not sufficient.

We recommend that you remove these stains before you put the items in the appliance.

Special stain removers are available. Use the special stain remover that is applicable to the type of stain and fabric.

13.3 Detergents and additives

- Only use detergents and additives specially made for washing machines:
 - powder detergents for all types of fabric,
 - powder detergents for delicate fabrics (40 °C max) and woollens,
 - liquid detergents, preferably for low temperature wash programmes (60 °C max) for all types of fabric, or special for woollens only.
- Do not mix different types of detergents.
- To help the environment, do not use more than the correct quantity of detergent.
- Obey the instructions that you find on the on packaging of these products.

- Use the correct products for the type and colour of the fabric, the programme temperature and the level of soil.
- If your appliance has not the detergent dispenser with the flap device, add the liquid detergents with a dosing ball (supplied by the detergent's manufacturer).
- Synthetic curtains.
- Pieces of clothing with metal inserts.
- Nylon stockings.
- Quilts.
- Bed covers.
- Duvets.
- Anoraks.
- Sleeping bags
- Fabrics with residue of hair sprays, nail solvents or similar.
- Garments with foam-rubber or materials similar to foam-rubber.

13.4 Ecological hints

- Set a programme without the prewash phase to wash laundry with normal soil.
- Always start a washing programme with the maximum load of laundry.
- If necessary, use a stain remover when you set a programme with a low temperature.
- To use the correct quantity of the detergent, check the water hardness of your domestic system

13.5 Water hardness

If the water hardness in your area is high or moderate, we recommend that you use a water softener for washing machines. In areas where the water hardness is soft it is not necessary to use a water softener.

To know the water hardness in your area, contact your local water authority.

Use the correct quantity of the water softener. Obey the instructions that you find on the packaging of the product.

13.6 Drying hints

Prepare the drying cycle

- Open the water tap.
- Do a check if the connection of the drain hose is correct. Refer to installation chapter for more information.
- For the maximum laundry load of the drying programmes, refer to the drying programmes table.





13.7 Items not to dry

Do not set a drying programme for this laundry:

- Very delicate items.

13.8 Garment labels

When you dry the laundry, obey the indications on the labels of the manufacturers:

-  = The item can be tumble dried
-  = The drying cycle is at high temperature
-  = The drying cycle is at reduced temperature
-  = The item can not be tumble dried.

13.9 Drying cycle duration

The drying time can change depending on:

- speed of the last spin
- dryness level
- type of laundry
- weight of the load size

13.10 Additional drying

If, at the end of the drying programme, the laundry is still damp, set a short drying cycle again.



WARNING!

To avoid creases of fabrics or shrinks of the clothing do not over dry the laundry.

13.11 General Tips

Refer to the «Drying programmes» table to find the **average** drying times.

The experience will help you to dry the laundry in a more correct way. Take note

of the duration drying time of the cycles done before.

To avoid the static charge at the end of the drying cycle:

1. Use fabric conditioner in the washing cycle.

2. Use special fabric conditioner for tumble dryers.

When the drying programme is completed remove the laundry in a short time.

14. CARE AND CLEANING



WARNING!
Refer to Safety chapters.

14.1 External cleaning

Clean the appliance only with soap and warm water. Fully dry all the surfaces.



CAUTION!
Do not use alcohol, solvents or chemical products.

14.2 Descaling

If the water hardness in your area is high or moderate, we recommend that you use a water descaling product for washing machines.

Regularly examine the drum to prevent limescale and rust particles.

To remove rust particles use only special products for washing machine. Do this separately from the laundry wash.



Always obey the instructions that you find on the packaging of the product.

14.3 Maintenance wash

With the low temperature programmes it is possible that some detergent stays in the drum. Make regularly a maintenance wash. To do this:

- Remove the laundry from the drum.
- Set the cotton programme with the highest temperature with a small quantity of detergent.

14.4 Door seal

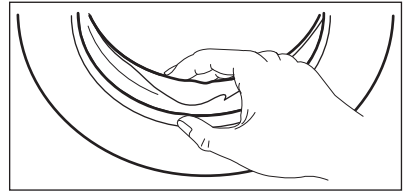

Regularly examine the seal and remove all objects from the inner part.

14.5 Cleaning the detergent dispenser

1.

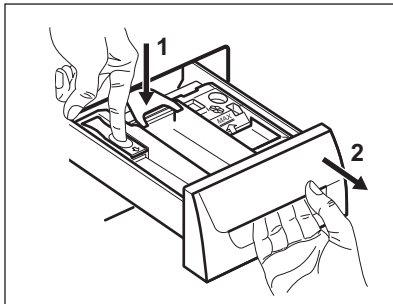

2.

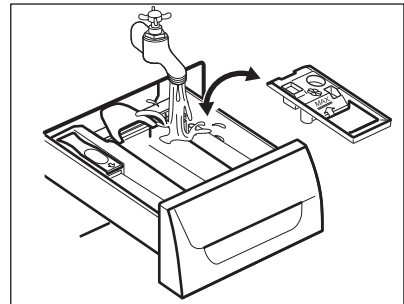

3.

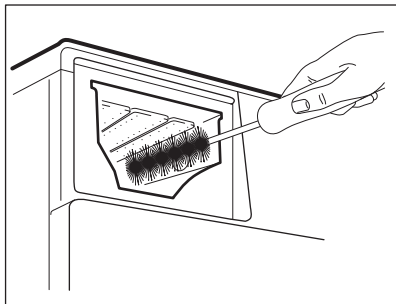

4.

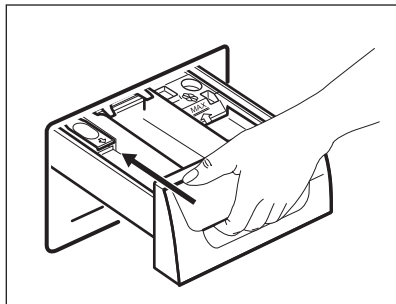

14.6 Cleaning the drain filter



Do not clean the drain filter if the water in the appliance is hot.

1.

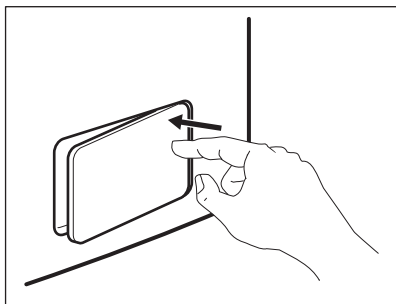

2.

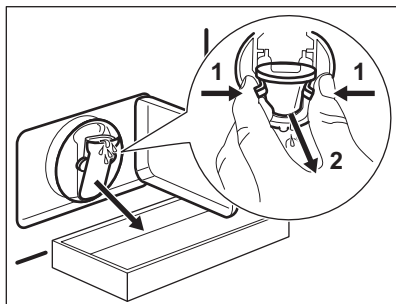

3.

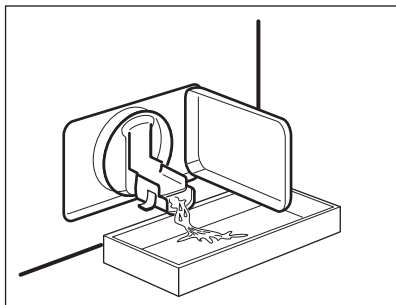

4.

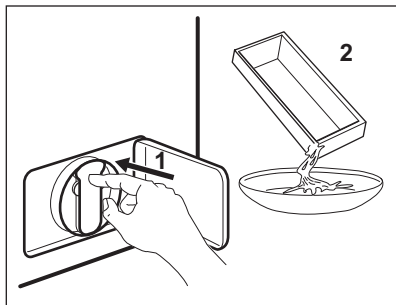

5.

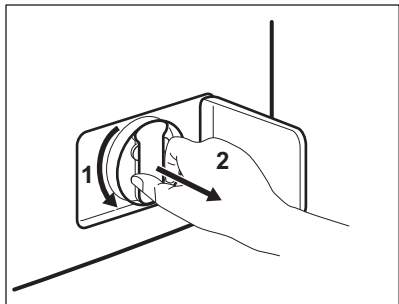

6.

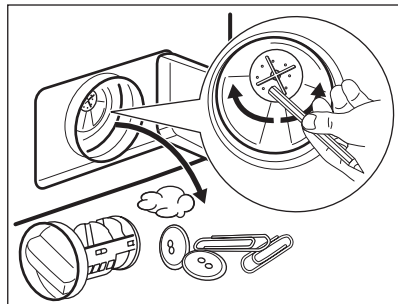

7.

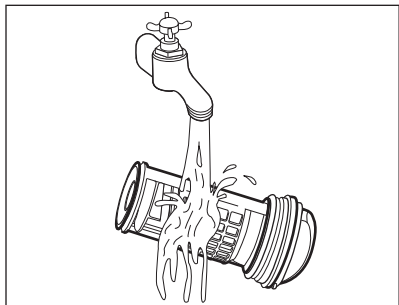

8.

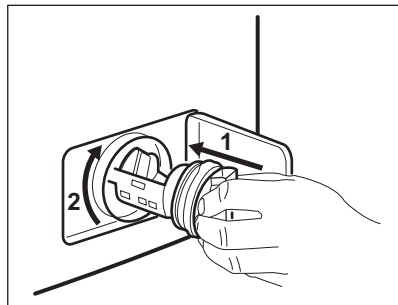

9.

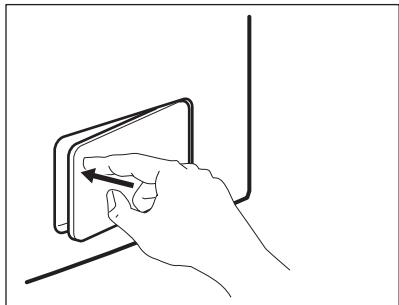

14.7 Cleaning the inlet hose and the valve filter

1.

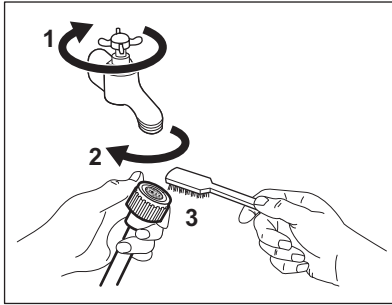

2.

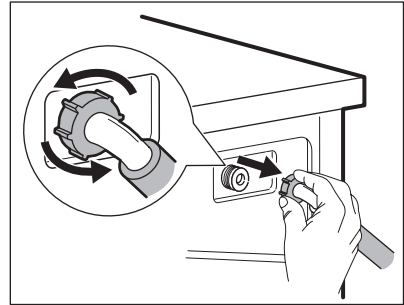

3.

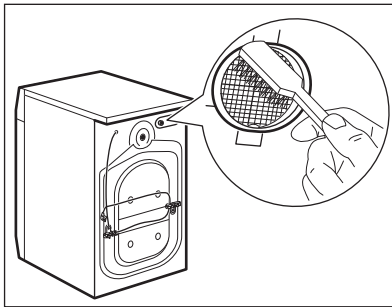

4.

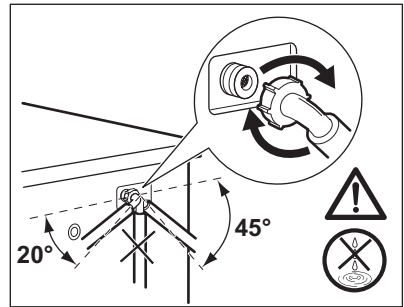

14.8 Emergency drain

Because of a malfunction, the appliance cannot drain the water.

If this occurs, do steps (1) through (9) of 'Cleaning the drain filter'. If necessary, clean the pump.

When you drain the water with the emergency drain procedure, you must activate again the drain system:

1. When you drain the water with the emergency drain procedure, you must activate again the drain system: Put 2 litres of water in the main wash compartment of the detergent dispenser.
2. Start the programme to drain the water

14.9 Frost precautions

If the appliance is installed in an area where the temperature can be less than

0° C, remove the remaining water from the inlet hose and the drain pump.

1. Disconnect the mains plug from the mains socket.
2. Close the water tap.
3. Put the two ends of the inlet hose in a container and let the water flow out of the hose.
4. Empty the drain pump. Refer to the emergency drain procedure.
5. When the drain pump is empty, install the inlet hose again.



WARNING!

Make sure that the temperature is more than 0 °C before you use the appliance again. The manufacturer is not responsible for damages caused by low temperatures.

15. TROUBLESHOOTING



WARNING!
Refer to Safety chapters.

15.1 Introduction

The start of the appliance does not occur or it stops during operation.

First try to find a solution to the problem (refer to the table). If not, contact the Authorised Service Centre.

With some problems, the acoustic signals operate and the display shows an alarm code:

- **E10** - The appliance does not fill with water properly.

- **E20** - The appliance does not drain the water.
- **E40** - The appliance door is open or not closed correctly. Please check the door!
- **E80** - The mains supply is unstable. Wait until the mains supply is stable.
- **E91** - No communication between electronic elements of the appliance. Switch off and switch on again.



WARNING!
Deactivate the appliance before you do the checks.

15.2 Possible failures

Problem	Possible solution
The programme does not start.	Make sure that the mains plug is connected to the mains socket.
	Make sure that the appliance door is closed.
	Make sure that there is not a damaged fuse in the fuse box.
	Make sure that the Start/Pause has been pressed.
	If the delay start is set, cancel the setting or wait for the end of countdown.
	Deactivate the Child Lock function if it is on.
The appliance does not fill with water properly.	Make sure that the water tap is open.
	Make sure that the pressure of the water supply is not too low. For this information, contact your local water authority.
	Make sure that the water tap is not clogged.
	Make sure that the filter of the inlet hose and the filter of the valve are not clogged. Refer to "Care and cleaning".
	Make sure that the inlet hose has no kinks or bends.
The appliance does not fill with water and drain immediately.	Make sure that the connection of the water inlet hose is correct.
	Make sure that the drain hose is in the correct position. The hose may be too low.

Problem	Possible solution
The appliance does not drain the water.	Make sure that the sink spigot is not clogged.
	Make sure that the drain hose has no kinks or bends.
	Make sure that the drain filter is not clogged. Clean the filter, if necessary. Refer to 'Care and cleaning'.
	Make sure that the connection of the drain hose is correct.
	Set the drain programme if you set a programme without drain phase.
The spin phase does not operate or the washing cycle lasts longer than usually.	Set the drain programme if you set an option which ends with water in the tub.
	Set the spin programme.
	Make sure that the drain filter is not clogged. Clean the filter, if necessary. Refer to 'Care and cleaning'.
There is water on the floor.	Adjust manually the items in the tub and start the spin phase again. This problem may be caused by balance problems.
	Make sure that the couplings of the water hoses are tight and there is not water leakages.
You cannot open the appliance door.	Make sure that the drain hose have no damages.
	Make sure you use the correct detergent and the correct quantity of it.
	Make sure that the washing programme is finished.
The appliance makes an unusual noise.	Set the drain or the spin programme if there is water in the drum.
	Make sure that the appliance receives electrical power.
	This problem may be caused by a failure of the appliance. Contact the Authorised Service Centre. If you need to open the door, please read carefully «Emergency door opening».
The appliance makes an unusual noise.	Make sure the levelling of the appliance is correct. Refer to 'Installation'.
	Make sure that the packaging and/or the transit bolts are removed. Refer to 'Installation'.
	Add more laundry in the drum. The load may be too small.

Problem	Possible solution
The cycle is shorter than the time displayed.	The appliance calculates a new time according to the laundry load. See the 'Consumption Values' chapter.
The cycle is longer than the time displayed.	An unbalanced laundry load increases the duration time. This is a normal behaviour of the appliance.
The washing results are not satisfactory.	Increase the detergent quantity or use a different detergent. Use special products to remove the stubborn stains before you wash the laundry.
	Make sure that you set the correct temperature.
	Decrease the laundry load.
You cannot set an option.	Make sure that you press only the wanted button(s).
The appliance does not dry or does not dry correctly.	Turn the water tap on. Make sure the drain filter is not clogged. Reduce the laundry load. Make sure you have set the correct cycle. if necessary ,set again a short drying time.
The laundry is full of different colours fluff.	The fabrics washed in the previous cycle released fluff of a different colour: <ul style="list-style-type: none"> • The drying phase helps to eliminate some fluff. • Clean the clothes with a fluff remover. <p>In case of an excessive amount of fluff in the drum run the special programme to clean it (refer to "Fluff in the fabrics" for more details).</p>

After the check, activate the appliance. The programme continues from the point of interruption.

If the problem occurs again, contact the Authorised Service Centre.

If the display shows other alarm codes. Deactivate and activate the appliance. If the problem continues, contact the Authorised Service Centre.

16. EMERGENCY DOOR OPENING

In case of power failure or appliance failure the appliance door remains locked. The washing programme continues, when the power is restored. If the door remains locked in case of failure, it is possible to open it using the emergency unlock feature.

Before opening the door:



CAUTION!
Make sure that the water temperature and the laundry are not hot. Wait till they cool down, if necessary.



CAUTION!
Make sure that the drum is not rotating. Wait till the drum stops rotating, if necessary.



Make sure that the water level inside the drum is not too high. Proceed with an emergency drain, if necessary (refer to «Emergency drain» in «Care and cleaning» chapter).

To open the door, proceed as follows:

1. Press the button Açık/Kapalı to switch the appliance off.
2. Disconnect the mains plug from the mains socket.

3. Open the filter flap.
4. Keep the emergency unlock trigger pulled downward and, at the same time, open the appliance door.

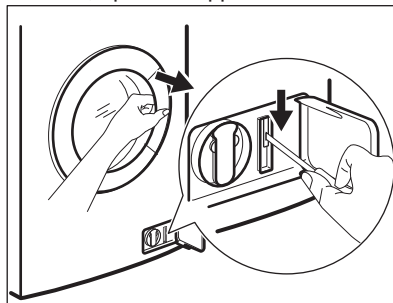



5. Take out the laundry and then close the appliance door.
6. Close the filter flap.

17. TECHNICAL DATA

Dimension	Width/ Height/ Depth/ Total depth	600 mm/ 850 mm/ 522 mm/ 555 mm
Electrical connection	Voltage Overall power Fuse Frequency	230 V 2200 W 10 A 50 Hz
Level of protection against ingress of solid particles and moisture ensured by the protective cover, except where the low voltage equipment has no protection against moisture		IPX4
Water supply pressure	Minimum Maximum	0,5 bar (0,05 MPa) 8 bar (0,8 MPa)
Maximum wash load	Cotton	8 kg
Maximum dry load	Cotton Synthetics	4 kg 2 kg
Spin Speed	Maximum	1600 rpm

18. ENVIRONMENT CONCERNS

Recycle the materials with the symbol . Put the packaging in applicable containers to recycle it. Help protect the environment and human health and to recycle waste of electrical and electronic appliances. Do not dispose appliances

marked with the symbol  with the household waste. Return the product to your local recycling facility or contact your municipal office.

www.electrolux.com/shop



132896590-A-232015

