



## CONTENTS

1. SAFETY INFORMATION.....	3
2. SAFETY INSTRUCTIONS.....	5
3. PRODUCT DESCRIPTION.....	7
4. CONTROL PANEL.....	8
5. PROGRAMMES .....	10
6. CONSUMPTION VALUES.....	14
7. OPTIONS.....	15
8. SETTINGS.....	16
9. BEFORE FIRST USE.....	16
10. DAILY USE.....	17
11. DAILY USE - DRYING ONLY.....	20
12. DAILY USE - WASHING & DRYING.....	21
13. HINTS AND TIPS.....	23
14. CARE AND CLEANING.....	25
15. TROUBLESHOOTING.....	28
16. TECHNICAL DATA.....	32

## FOR PERFECT RESULTS

Thank you for choosing this AEG product. We have created it to give you impeccable performance for many years, with innovative technologies that help make life simpler features you might not find on ordinary appliances. Please spend a few minutes reading to get the very best from it.

Visit our website for:



Get usage advice, brochures, trouble shooter, service information:  
**[www.aeg.com](http://www.aeg.com)**



Register your product for better service:  
**[www.registreaeg.com](http://www.registreaeg.com)**



Buy Accessories, Consumables and Original spare parts for your appliance:  
**[www.aeg.com/shop](http://www.aeg.com/shop)**

## CUSTOMER CARE AND SERVICE

Always use original spare parts.

When contacting our Authorised Service Centre, ensure that you have the following data available: Model, PNC, Serial Number.

The information can be found on the rating plate.



Warning / Caution-Safety information



General information and tips



Environmental information

Subject to change without notice.

## 1. SAFETY INFORMATION

Before the installation and use of the appliance, carefully read the supplied instructions. The manufacturer is not responsible if an incorrect installation and use causes injuries and damages. Always keep the instructions with the appliance for future reference.

### 1.1 Children and vulnerable people safety

**WARNING!**

Risk of suffocation, injury or permanent disability.

- This appliance can be used by children aged from 8 years and above and persons with reduced physical, sensory or mental capabilities or lack of experience and knowledge if they have been given supervision or instruction concerning use of the appliance in a safe way and understand the hazards involved.
- Do not let children play with the appliance.
- Children of less than 3 years should be kept away unless continuously supervised.
- Keep all packaging away from children.
- Keep all detergents away from children.
- Keep children and pets away from the appliance door when it is open.
- If the appliance has a child safety device, we recommend you activate it.
- Cleaning and user maintenance shall not be made by children without supervision.

### 1.2 General Safety

- Do not change the specification of this appliance.
- The appliance can be installed as freestanding or below the kitchen counter with correct space.
- Do not install the appliance behind a lockable door, a sliding door or a door with a hinge on the opposite

side, where the appliance door can not be fully opened.

- Connect the mains plug to the mains socket only at the end of the installation. Make sure that there is access to the mains plug after the installation.
- The ventilation openings in the base (if applicable) must not be obstructed by a carpet.
- Ensure you have good ventilation in the installation room to avoid the back flow of gases into the room from appliances burning other fuels, including open fires.
- Exhaust air must not be discharged into a flue which is used for exhausting fumes from appliances burning gas or other fuels (if applicable).
- The operating water pressure (minimum and maximum) must be between 0,5 bar (0,05 MPa) and 8 bar (0,8 MPa).
- Obey the maximum load volume of 7 kg (refer to the "Programme chart" chapter).
- The appliance is to be connected to the water mains using the new supplied hose-sets. Old hose sets must not be reused.
- If the supply cord is damaged, it must be replaced by the manufacturer, its Authorised Service Centre or similarly qualified persons in order to avoid a hazard.
- Wipe away lint that has accumulated around the appliance.
- Items that have been soiled with substances such as cooking oil, acetone, alcohol, petrol, kerosene, spot removers, turpentine, waxes and wax removers should be washed in hot water with an extra amount of detergent before being dried in the wash dryer.
- Do not use the appliance if industrial chemicals have been used for cleaning.
- Do not dry unwashed items in the wash dryer.
- Items such as foam rubber (latex foam), shower caps, waterproof textiles, rubber backed articles and clothes

or pillows fitted with foam rubber pads should not be dried in the wash dryer.

- Fabric softeners, or similar products, should be used as specified by the fabric softener instructions.
- Remove all objects from pockets such as lighters and matches.
- Never stop the wash dryer before the end of the drying cycle unless all items are quickly removed and spread out so that the heat is dissipated.
- The final part of a wash dryer cycle occurs without heat (cool down cycle) to ensure that the items are left at a temperature that ensures that the items will not be damaged.
- Do not use water spray and steam to clean the appliance.
- Clean the appliance with a moist soft cloth. Only use neutral detergents. Do not use abrasive products, abrasive cleaning pads, solvents or metal objects.
- Before maintenance, deactivate the appliance and disconnect the mains plug from the mains socket.

## 2. SAFETY INSTRUCTIONS

### 2.1 Installation

- Remove all the packaging and the transit bolts.
- Keep the transit bolts. When you move the appliance again you must block the drum.
- Always be careful when you move the appliance because it is heavy. Always wear safety gloves.
- Do not install or use a damaged appliance.
- Obey the installation instruction supplied with the appliance.
- Do not install or use the appliance where the temperature is less than 0 °C or where it is exposed to the weather.
- Make sure that the floor where you install the appliance is flat, stable, heat resistant and clean.
- Do not install the appliance where the appliance door can not be fully opened.
- Always move the appliance vertically.
- The rear surface of the appliance must be put against the wall.
- Make sure that there is air circulation between the appliance and the floor.
- Adjust the feet to have the necessary space between the appliance and the carpet.
- When the appliance is put in its permanent position, check if it is fully level with the aid of a spirit level. If it is not, adjust the feet until it is.

### 2.2 Electrical Connection



#### **WARNING!**

Risk of fire and electrical shock.

- The appliance must be earthed.

- Always use a correctly installed shockproof socket.
- Do not use multi-plug adapters and extension cables.
- Do not pull the mains cable to disconnect the appliance. Always pull the mains plug.
- Do not touch the mains cable or the mains plug with wet hands.
- Only for UK and Ireland: The appliance has a 13 amp mains plug. If it is necessary to change the fuse in the mains plug, use a 13 amp ASTA (BS 1362) fuse.
- This appliance complies with the E.E.C. Directives.

## 2.3 Water Connection

- Make sure not to cause damage to the water hoses.
- Before you connect the appliance to new pipes or pipes not used for a long time, let the water flow until it is clean.
- The first time you use the appliance, make sure that there is no leakage.

## 2.4 Use



### **WARNING!**

Risk of injury, electrical shock, fire, burns or damage to the appliance.

- Use this appliance in a household only.
- Do not change the specification of this appliance.

- Do not put flammable products or items that are wet with flammable products in, near or on the appliance.
- Do not touch the glass of the door while a programme operates. The glass can be hot.
- Do not dry the damaged items which contain padding or fillings.
- If you have washed your laundry with a stain remover start an extra rinse cycle before you start a drying cycle.
- Make sure that you remove all metal objects from the laundry.
- Only dry fabrics which are applicable to dry in the washer-dryer. Follow the instructions on the fabric label.
- Plastic items are not heat resistant.
  - If you use a detergent ball, remove it before you set the drying programme.
  - Do not use a detergent ball when you set a non-stop programme.



### **WARNING!**

Risk of injury or damage to the appliance.

- Do not sit or stand on the open door.
- Do not dry dripping wet clothes in the appliance.

## 2.5 Disposal

- Disconnect the appliance from the mains supply.
- Cut off the mains cable and discard it.
- Remove the door catch to prevent children and pets to get closed in the appliance.

## 3. PRODUCT DESCRIPTION

### 3.1 Appliance overview

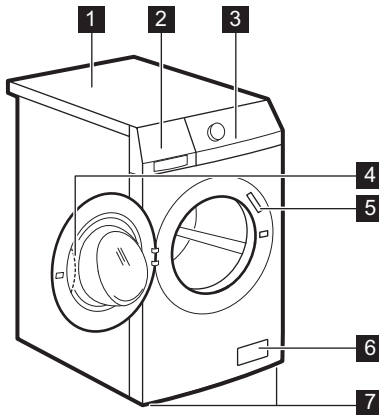

- 1** Worktop
- 2** Detergent dispenser
- 3** Control panel
- 4** Door handle
- 5** Rating plate
- 6** Drain pump filter
- 7** Feet for the appliance level

### 3.2 How to activate the child safety device

This device prevents children or pets to be closed in the drum.

Turn the device clockwise, until the groove is horizontal.  
You cannot close the door.

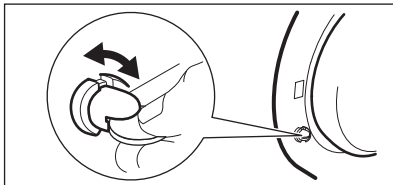

To close the door, turn the device anticlockwise until the groove is vertical.

### 3.3 Installation on suspended flooring

Suspended wooden floors are particularly susceptible to vibration.

To help prevent vibration we recommend you place a waterproof wood panel, at least 15 mm thick under the appliance, secured to at least 2 floor beams with screws, the wood panel must extend beyond the front feet.

If possible install the appliance in one of the corners of the room, where the floor is more stable.

### 3.4 Fixing plate kit (4055171146)

Available from your authorized dealer.

If you install the appliance on a plinth, secure the appliance in the fixing plates.

Read carefully the instructions supplied with the accessory.

## 4. CONTROL PANEL

### 4.1 Control panel description

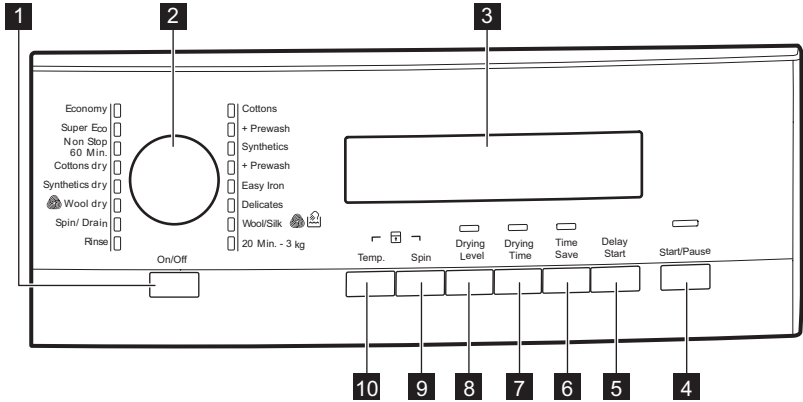

- |                             |                              |
|-----------------------------|------------------------------|
| <b>1</b> On/Off button      | <b>7</b> Drying time button  |
| <b>2</b> Programme knob     | <b>8</b> Drying level button |
| <b>3</b> Display            | <b>9</b> Spin button         |
| <b>4</b> Start/Pause button | <b>10</b> Temperature button |
| <b>5</b> Delay Start button |                              |
| <b>6</b> Time Save button   |                              |

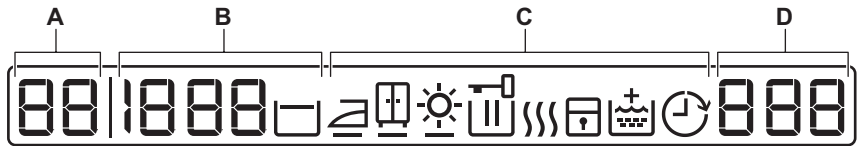

### 4.2 Display











Temperature area:

A	88	Temperature indicator
	--	Cold water indicator.



Spin area:	
B	 Spin speed indicator
	 No Spin indicator <sup>1)</sup>
	 Rinse Hold indicator

<sup>1)</sup> Only available for Spin/Drain programme.

Dryness level symbols <sup>1)</sup> :	
	 Iron dry
	 Cupboard dry
	 Extra dry
Display indicators <sup>2)</sup> :	
C	 Door locked - You <b>cannot</b> open the door when this symbol is on. You <b>can</b> open the door only when the symbol goes off.
	 Washing phase
	 Drying phase
	 Child safety lock
	 Extra rinse
	 Delay start

<sup>1)</sup> They come on when you set an automatic drying programme.



<sup>2)</sup> The symbols appear on the display when the related phase or function is set.

Time area:	
1:25	Programme duration (washing and/or drying phase) When the programme starts, the time decreases with steps of 1 minute.
2h	Delay start When you press the delay start button, the display shows the delay start time.
D E20	Alarm codes If the appliance has a malfunction, the display shows alarm codes. Refer to 'Troubleshooting' chapter.
Err	Message of error The display shows this message for some seconds when: <ul style="list-style-type: none"> <li>You cannot set a function with the washing programme.</li> <li>You try to change the washing programme while it operates.</li> </ul>
□	Programme is completed

## 5. PROGRAMMES

### 5.1 Programme Chart

Programme Temperature range	Maximum load Maximum spin speed	Programme description (Type of load and soil level)
<b>Washing programmes</b>		
Cottons 95°C - Cold	7 kg 1600 rpm	<b>White cotton and coloured cotton.</b> Normal soil and light soil.
Cottons + Pre-wash 95°C - Cold	7 kg 1600 rpm	<b>White cotton and coloured cotton.</b> Heavy soil and normal soil.
Synthetics 60°C - Cold	3 kg 1200 rpm	<b>Synthetic items or mixed fabric items.</b> Normal soil.
Synthetics + Pre-wash 60°C - Cold	3 kg 1200 rpm	<b>Synthetic items or mixed fabric items.</b> Heavy soil and normal soil.

Programme Temperature range	Maximum load Maximum spin speed	Programme description (Type of load and soil level)
Easy Iron 60°C - Cold	3 kg 800 rpm	<b>Synthetic items to be gentle washed.</b> Normal and light soil. <sup>1)</sup>
Delicates 40°C - Cold	3 kg 1200 rpm	<b>Delicate fabrics as acrylics, viscose, polyester items.</b> Normal soil.
 Wool/Silk 40°C - Cold	1.5 kg 1200 rpm	<b>Machine washable wool, hand washable wool and delicate fabrics</b> with «hand washing» care symbol. <sup>2)</sup>
20 Min. - 3 Kg 40°C - 30°C	3 kg 1200 rpm	<b>Cottons and synthetics items with light soil level</b> or worn only once.
Rinse	7 kg 1600 rpm	To rinse and spin the laundry. <b>All fabrics.</b>
Spin/Drain <sup>3)</sup>	7 kg 1600 rpm	To spin the laundry and to drain the water in the drum. <b>All fabrics.</b>
<b>Drying programmes</b>		
 Wool dry	1 kg	Drying programme for <b>woollen.</b>
Synthetics dry	2 kg	Drying programme for <b>synthetic items.</b>
Cottons dry	4 kg	Drying programme for <b>cotton items.</b>
Non Stop 60 Min. 30°C	1 kg 1200 rpm	Complete programme composed of washing phase + drying phase for a small load size of mixed fabrics (cottons and synthetics items).
<b>Saving energy programmes</b>		
Super Eco Cold	3 kg 1200 rpm	<b>Mixed fabric</b> (cotton and synthetic items). <sup>4)</sup>

Programme Temperature range	Maximum load Maximum spin speed	Programme description (Type of load and soil level)
Economy <sup>5)</sup> 60°C - 40°C	7 kg 1600 rpm	<b>White cotton and colour-fast cotton.</b> Normal soil. The energy consumption decreases and the time of the washing programme is extended.

1) To reduce the creases of the laundry, this cycle regulates the water temperature and performs a soft wash and spin phase. The appliance adds some rinses. This programme is not compatible with drying.

2) During this cycle the drum rotates slowly to ensure a gentle washing. It can seem that the drum doesn't rotate or doesn't rotate properly. Consider this as a normal functioning of the appliance.

3) Set the spin speed. Make sure it agrees with the laundry. If you set No Spin option the only drain phase is available.

4) This programme is for daily use and has lowest energy and water consumption maintaining a good washing performance.

5) The washing programme Economy at 60°C with a load of 7 kg and the drying programme Cottons dry are the reference programmes for the data entered in the energy label, in compliance with EEC 92/75 standards.



The water temperature of the washing phase may differ from the temperature declared for the selected programme.

#### Programme options compatibility

Programme	Spin	- - -		Extra Rinse <sup>1)</sup>	Time Save <sup>2)</sup>	Delay Start
Cottons	■		■	■	■	■
Cottons + Prewash	■		■	■	■	■
Synthetics	■		■	■	■	■
Synthetics + Prewash	■		■	■	■	■
Easy Iron	■		■	■	■	■
Delicates	■		■	■	■	■
Wool/Silk	■		■			■
20 Min. - 3 Kg	■					■
Rinse	■		■	■		■
Spin/Drain <sup>3)</sup>	■	■				■
Super Eco	■		■			■

Programme	Spin	---		Extra Rinse <sup>1)</sup>	Time Save <sup>2)</sup>	Delay Start
Economy	■		■	■	■ <sup>4)</sup>	■



<sup>1)</sup> If the Permanent Extra Rinse option is activated, the appliance adds some additional rinses. In the Rinse programme, if you set a low spin speed the appliance performs delicate rinses and a short spin.

<sup>2)</sup> If you set a shorter duration, we recommend that you decrease the quantity of the load. It is possible to load fully the appliance, however the washing results are reduced.

<sup>3)</sup> Set the spin speed. Make sure it agrees with the laundry. If you set No Spin option the only drain phase is available.

<sup>4)</sup> For this programme you can set only the Extra Quick duration.

## 5.2 Programmes for automatic drying

Dryness Level	Type of fabric	Load
 <b>Extra Dry</b> For towelling materials	<b>Cottons and Linen</b> (bathrobes, bath towels, etc)	up to 4 kg
 <b>Cupboard Dry<sup>1)</sup></b> For items to put away	<b>Cottons and Linen</b> (bathrobes, bath towels, etc)	up to 4 kg
	<b>Synthetics and mixed fabrics</b> (jumpers, blouses, underwear, household linen)	up to 2 kg
 <b>Iron Dry</b> Suitable for ironing	<b>Cottons and Linen</b> (sheets, tablecloths, shirts, etc)	up to 4 kg

<sup>1)</sup> **Hints for test institute** The test performance, in accordance with EN 50229, must be carried out with a FIRST drying load of the maximum declared drying capacity (load composition according to EN61121) by setting the AUTOMATIC CUPBOARD DRY programme for Cotton. The SECOND drying load with the residual load must be tested by setting the AUTOMATIC CUPBOARD DRY programme for Cotton.

## 5.3 Programmes for timed drying

Dryness Level	Type of fabric	Load (kg)	Spin speed (rpm)	Suggested duration (mins)
<b>Extra Dry</b> For towelling materials	<b>Cottons and Linen</b> (bathrobes, bath towels, etc)	4	1600	140 - 155
		2	1600	75 - 90
		1	1600	50 - 60

Dryness Level	Type of fabric	Load (kg)	Spin speed (rpm)	Suggested duration (mins)
<b>Cupboard Dry</b> For items to put away	<b>Cottons and Linen</b> (bathrobes, bath towels, etc)	4	1600	130 - 145
		2	1600	65 - 80
		1	1600	40 - 50
<b>Cupboard Dry</b> For items to put away	<b>Synthetics and mixed fabrics</b> (jumpers, blouses, underwear, household linen)	2	1200	95 - 110
		1	1200	45 - 55
<b>Iron Dry</b> Suitable for ironing	<b>Cottons and Linen</b> (sheets, tablecloths, shirts, etc)	4	1600	95 - 110
		2	1600	50 - 60
		1	1600	30 - 40
<b>Wool dry</b>	<b>Wool</b> (wool jumpers)	1	1200	80 - 100

## 5.4 Woolmark Apparel Care - Blue



- The wool wash cycle of this machine has been approved by The Woolmark Company for the washing of wool garments labelled as «hand wash» provided that the garments are

washed according to the instructions issued by the manufacturer of this washing machine. Follow the garment care label for drying and other laundry instructions. M1380

- The wool drying cycle of this machine has been approved by The Woolmark Company for the drying of wool garments labelled as «hand wash» provided that the garments are dried according to the instructions issued by the manufacturer of this machine. Follow the garment care label for other laundry instructions. M1381
- In UK, Eire, Hong Kong and India the Woolmark symbol is a certification trademark.

## 6. CONSUMPTION VALUES



The data of this table are approximate. Different causes can change the data: the quantity and type of laundry, the water and ambient temperature.



At programme start the display shows the duration programme for the maximum load capacity.  
 During the washing phase the programme duration is automatically calculated and can be greatly reduced if the laundry load is lower than the maximum load capacity (e.g. Cotton 60°C, maximum load capacity 7 kg, the programme duration exceeds 2 hours; real load 1 kg, the programme duration don't reach 1 hour).  
 When the appliance is calculating the real programme duration a dot blinks in the display.

Programmes	Load (kg)	Energy consumption (kWh)	Water consumption (litre)	Approximate programme duration (minutes)
Cottons 60 °C	7	1.30	62	157
Economy Cotton Energy Saving Programme 60 °C <sup>1)</sup>	7	1.02	55	258
Cottons 40 °C	7	0.80	62	154
Synthetics 40 °C	3	0.50	66	110
Delicates 40 °C	3	0.53	50	100
Wool/Handwash 30 °C	1.5	0.25	45	56

<sup>1)</sup> «Cotton Energy Saving programme » at 60°C with a load of 7 kg is the reference programme for the data entered in the energy label, in compliance with EEC 92/75 standards.

## 7. OPTIONS

### 7.1 Temperature

Set this option to change the default temperature.

Indicator **--** = cold water.

The display shows the set temperature.

### 7.2 Spin

With this option you can decrease the default spin speed.

The display shows the indicator of the set speed.

#### Additional spin options:

##### No Spin

- Set this option to remove all spin phases.
- Set it for very delicate fabrics.

- The rinse phase uses more water for some washing programmes.
- The display shows the indicator **---**.

#### Rinse Hold



- Set this option to prevent the laundry creases.
- The washing programme stops with the water in the drum. The drum turns regularly to prevent the laundry creases.
- The door stays locked. You must drain the water to unlock the door.
- The display shows the indicator .



To drain the water refer to 'At the end of the programme'.

## 7.3 Drying level

Press this button to set one of 3 automatic dryness levels proposed by the appliance. The display shows the symbol of the set level:

-  **Iron dry** – laundry to be ironed
-  **Cupboard dry** – laundry to be put in store
-  **Extra dry** – laundry to be fully dried

 You **cannot** set all automatic levels for each type of fabrics.

## 7.4 Drying time

Press this button to set the time that suits the fabrics you have to dry. The display shows the set value.

Each time you press this button the time value increases by 5 minutes.

 You **cannot** set all time values for different types of fabrics.

## 7.5 Time Save

With this option you can decrease the programme duration.

- Press this button one time to set 'Shortened duration' for items with daily soil.
- Press this button two times to set 'Extra Quick' for items with almost no soil.

 Some programmes accept only one of the two options.

## 7.6 Delay Start

With this option you can delay the start of a programme from 30 minutes to 20 hours.

The display shows the related indicator and delay time.

# 8. SETTINGS

## 8.1 Acoustic signals

The acoustic signals operate when:

- You activate the appliance.
- You deactivate the appliance.
- You press the buttons.
- The programme is completed.
- The appliance has a malfunction.

To **deactivate/activate** the acoustic signals, press Drying Level and Drying Time at the same time for 6 seconds.

 If you deactivate the acoustic signals, they continue operate when the appliance has a malfunction.

## 8.2 Child Lock

With this option you can prevent that the children play with the control panel.

- To **activate/deactivate** this option, press Temp. and Spin at the same time until the indicator  **comes on/goes off**.

You can activate this option:

- After you press Start/Pause : the options and the programme knob are locked.
- Before you press Start/Pause : the appliance cannot start.

## 8.3 Permanent Extra Rinse

With this option you can permanently have an extra rinse when you set a new programme.

- To **activate/deactivate** this option press Time Save and Delay Start at the same time until the indicator Extra Rinse **comes on/goes off**.

# 9. BEFORE FIRST USE

1. Put 2 litre of water in the detergent compartment for washing phase.

This activates the drain system.



- Put a small quantity of detergent in the compartment for washing phase.
- Set and start a programme for cotton at the highest temperature without laundry.

This removes all possible dirt from the drum and the tub.

## 10. DAILY USE

### 10.1 Loading the laundry

- Open the appliance door
- Put the laundry in the drum, one item at a time.
- Shake the items before you put them in the appliance.

Make sure not to put too much laundry in the drum.

- Close the door firmly.

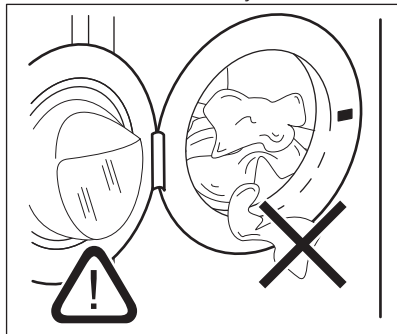



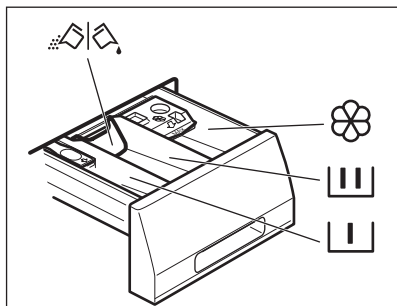

#### CAUTION!

Make sure that no laundry stays between the seal and the door. There is a risk of water leakage or damage to the laundry.

### 10.2 Filling the detergent and additives



-  Compartment for prewash phase, soak programme or stain remover.
-  Compartment for washing phase.
-  Compartment for liquid additives (fabric conditioner, starch).
- MAX** Maximum level for quantity of liquid additives.
-  Flap for powder or liquid detergent.



Always obey the instructions that you find on the packaging of the detergent products.

### 10.3 Check the position of the flap

- Pull out the detergent dispenser until it stops.
- Press the lever down to remove the dispenser.

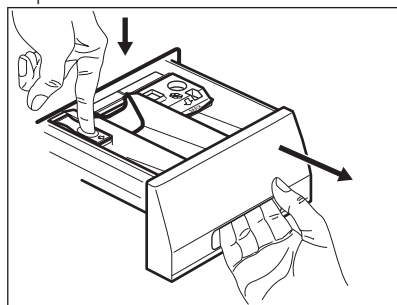

- To use powder detergent, turn the flap up.

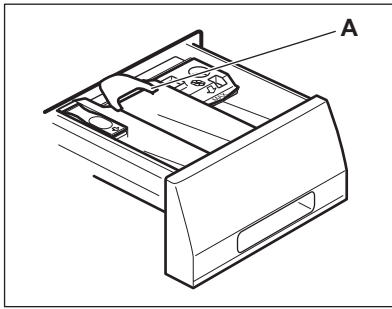

4. To use liquid detergent, turn the flap down.

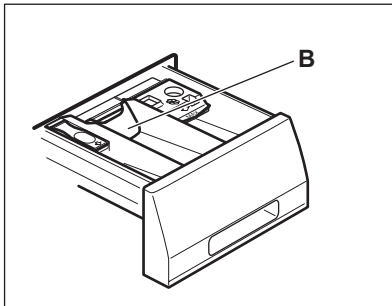

**With the flap in the position DOWN:**

- Do not use gelatinous or thick liquid detergents.
  - Do not put more liquid detergent than the limit showed in the flap.
  - Do not set the prewash phase.
  - Do not set the delay start function.
5. Measure out the detergent and the fabric conditioner.
  6. Carefully close the detergent dispenser.

Make sure that the flap does not cause a blockage when you close the drawer.

## 10.4 Activating the appliance

1. Open the water tap.
2. Connect the mains plug to the mains socket.

3. Press button On/Off to activate the appliance.

A short tune sounds.

## 10.5 Setting a programme

1. Turn the programme knob and set the programme:
  - The related programme indicator comes on.
  - The indicator of Start/Pause flashes.
  - The display shows: the default temperature, the spin speed, the indicators of the programme phases and the programme duration.
2. If necessary, change the temperature, the spin speed, the cycle duration, or add available options. When you activate an option, the indicator of the set option comes on.



If you set something incorrect, the display shows the message **Err**.

## 10.6 Starting a programme without the delay start

Press button Start/Pause to start the programme.

The relevant indicator stops to flash and stays on.

On the display the indicator of the phase is operation starts to flash.

The programme starts, the door is locked. The display show the indicator



The drain pump can operate for a short time when the appliance fills water.

## 10.7 Behaviour of the appliance

 After approximately 15 minutes from the start of the programme:

- The appliance adjusts automatically the cycle time to the laundry you have put in the drum to have perfect washing results in the minimum necessary time.
- The display shows the new time value.

## 10.8 Starting a programme with the delay start

1. Press button Delay Start again and again until the display shows the number of minutes or hours of delay.

The related indicator comes on.

2. Press button Start/Pause.

The appliance starts the countdown of the delay start.

When the countdown is completed, the programme starts automatically.

 Before you press button Start/Pause to start the appliance, you can cancel or change the set of the delay start.

## 10.9 Cancelling the delay start

To cancel the delay start:

1. Press button Start/Pause to set the appliance to pause.

The related indicator flashes.

2. Press button Delay Start repeatedly until the display shows .
3. Press button Start/Pause again to start the programme immediately.

## 10.10 Interrupting a programme and changing a function

You can change only some options before they operate.

1. Press button Start/Pause. The related indicator flashes.

2. Change the function set.
3. Press the button Start/Pause again. The programme continues.

## 10.11 Cancelling a running programme

1. Press button On/Off to cancel the programme and to deactivate the appliance.
2. Press button On/Off again to activate the appliance.

Now, you can set a new washing programme.

 Before starting the new programme the appliance could drain the water. In this case, make sure that the detergent is still in the detergent compartment, if not fill the detergent again.

## 10.12 Opening the door

 If the temperature and level of the water in the drum are too high and the drum still rotates you cannot open the door.

While a programme or the delay start operates, the appliance door is locked.

1. Press button Start/Pause. In the display the related door lock indicator goes off.
2. Open the appliance door.
3. Close the door and press button Start/Pause.

The programme or the delay start continues.

## 10.13 End of cycle

When the programme has finished, the appliance stops automatically. The acoustic signal operates (if it is active).

In the display  comes on and the door locked indicator  goes off.

The indicator of Start/Pause button goes off.

1. Press button On/Off to deactivate the appliance.

After five minutes from the end of the programme, the energy saving function automatically deactivates the appliance.



When you activate the appliance again, the display show the end of the last set programme. Turn the programme knob to set a new cycle.

2. Remove the laundry from the appliance.
3. Make sure that the drum is empty.
4. Keep the door ajar, to prevent mildew and odours

## 10.14 Draining water out after end of cycle

### The washing programme is completed, but there is water in the drum:

The drum turns regularly to prevent the creases in the laundry.

The door lock indicator  is on. The door stays locked.

You must drain the water to open the door:

1. If necessary, decrease the spin speed.
2. Press the Start/Pause button. The appliance drains the water and spins.
3. When the programme is completed and the door lock indicator  goes off, you can open the door .

4. Press On/Off some seconds to deactivate the appliance.



The appliance drains and spins automatically after approximately 18 hours.

## 10.15 AUTO Stand-by option

The AUTO Stand-by function automatically deactivates the appliance to decrease the energy consumption when:

- You do not use the appliance for 5 minutes before you press Start/Pause button. Press the button On/Off to activate the appliance again.
- After 5 minutes from the end of the washing programme Press the button On/Off to activate the appliance again. The display shows the end of the last set programme. Turn the programme knob to set a new cycle.



If you set a programme or an option that ends with water in the drum, the AUTO Stand-by function **doesn't deactivate** the appliance to remind you to drain the water.

# 11. DAILY USE - DRYING ONLY



**WARNING!**  
Refer to Safety chapters.

## 11.1 Drying setting



**WARNING!**  
**Make sure that the water tap is open.**

1. Press On/Off for some seconds to activate the appliance.
2. Load the laundry one item at a time.
3. Turn the programme dial to the programme applicable for the items



to dry. The display shows the drying indicator .



To have a good drying performance **do not** exceed the maximum drying loads recommended in the user manual. **Do not** set a spin speed lower than the automatic speed of the set programme.



## 11.2 Drying at automatic levels

The laundry can be dried at pre-defined levels of dryness:

- Press Drying level again and again until the display shows one of the dryness level indicator:
  - : IRON DRY level indicator for cotton items
  - : CUPBOARD DRY level indicator for cotton and synthetic items
  - : EXTRA DRY level indicator for cotton items

The display shows a time value, calculated on the default load size. If the amount of your laundry is more or less than the default size, the appliance adjusts automatically the time value during the cycle.



- Press Start/Pause to start the programme.

The display shows the door locked indicator . The drying indicator  starts to flash.



 You cannot set all dryness levels for any type of laundry.

## 11.3 Timed Drying

The laundry can also be dried with a manual timed drying:

- Press Drying time again and again to set the time value (see the «Programmes for timed drying» table).
  - The display shows the set time value: e.g. . Each time you press this button the time value increases by 5 minutes.
  - After some seconds the display shows a new time value: e.g. .

The appliance calculates also the duration of the anti-crease and the cooling phases.

- Press Start/Pause to start the programme.
  - The display shows regularly a new time value.
  - The drying indicator  starts to flash.
  - The display shows the door locked indicator .

 If you set only 10 minutes of drying, the appliance performs only a cooling phase. If the laundry is not sufficient dry, set again a short drying time.

## 11.4 End of the drying programme

The appliance stops automatically.

- The acoustic signals operate (if they are active).
- In the display  comes on.
- The indicator Start/Pause goes off.
- The last minutes of the drying cycle the appliance performs a cooling and anti-crease phase. The door is still locked.

When the door locked  goes off in the display, you can open the door.

- Press the button On/Off for some seconds to deactivate the appliance. After some minutes from the end of the programme, the energy saving function automatically deactivates the appliance.
- Remove the laundry from the appliance. Make sure that the drum is empty.
- Keep the door ajar, to prevent mildew and odours.

# 12. DAILY USE - WASHING & DRYING



**WARNING!**  
Refer to Safety chapters.

## 12.1 Non-Stop programme

- Press On/Off for some seconds to activate the appliance.

2. Load the laundry one item at a time.



To have a good drying performance **do not** exceed the maximum drying loads recommended in the user manual. **Do not** set a spin speed lower than the automatic speed of the set programme.

3. Put the detergent and the additives in the appropriate compartment.
4. Turn the programme dial to the washing programme.

The display shows the indicators of the different washing phases.

5. Set the available options.

## 12.2 Washing & Automatic drying

1. Press Drying level again and again until the display shows one of the dryness level indicator:
  - : IRON DRY level indicator for cotton items
  - : CUPBOARD DRY level indicator for cotton and synthetic items
  - : EXTRA DRY level indicator for cotton items

The display shows the indicator . The time value on the display is the duration of the washing + drying cycles, calculated on a default load size.



To have a good drying the appliance does not let you set a too low spin speed for the items to be washed and dried.

2. Press Start/Pause to start the programme.

In the display the indicator of the set dryness level stays on.

The door locked indicator goes on. The display shows regularly a new time value.



The last minutes of the drying cycle the appliance performs the anti-crease and the cooling phases.

## 12.3 Washing & Timed Drying

To have a good drying the appliance does not let you set a too low spin speed for the items to be washed and dried.

1. Press Drying time to set the drying time value. The display shows 10 minutes.

The indicator comes on in the display. The display shows the set drying value time. for example: . After some seconds the display shows the final time value , that is the total duration of the washing and drying cycles (washing + drying + anti-crease + cooling phases).



If you set only 10 minutes of drying after washing, the appliance calculates also the duration of the anti-crease and the cooling phases.

2. Press Start/Pause to start the programme.

In the display the indicator comes on. The door is locked. The display shows regularly a new time value.

## 12.4 End of the programme

The appliance stops automatically. The acoustic signals operate (if they are active).

For more information see 'At the end of the drying programme' of the previous chapter.

1. Remove the laundry from the appliance.
2. Keep the door ajar, to prevent mildew and odours.

## 12.5 Fluff in the fabrics

During the washing and/or drying phase, some types of fabric, (sponge, wool, sweatshirt) could release fluff.

The released fluff could stick to the fabrics during the next cycle.

This inconvenient increases with technical fabrics.

To prevent the fluff in your laundry, we recommend that you:

- To do not wash dark fabrics after you washed and dried light coloured fabrics (new sponge, wool, sweatshirt ) and the contrary.
  - To dry this type of fabrics at open air when they are washed the first time.
  - To clean the drain filter.
  - After the drying phase, clean the empty drum, the gasket and the door with a wet cloth.
1. Empty the drum.
  2. Clean the drum, the gasket and the door with a wet cloth.
  3. Set the rinse programme.
  4. Press at the same time Spin and Drying Time to activate the cleaning function until the display shows **CLE**.
  5. Press Start/Pause to start the programme.

## 12.6 How to remove the fluff in the garments

To remove the fluff inside the drum, set a special programme:

# 13. HINTS AND TIPS



### WARNING!

Refer to Safety chapters.

## 13.1 The laundry load

- Divide the laundry in: white, coloured, synthetics, delicates and wool.
- Obey the washing instructions that are on the laundry care labels.
- Do not wash together white and coloured items.
- Some coloured items can discolour with the first wash. We recommend that you wash them separately for the first times.
- Button up pillowcases, close zippers, hooks and poppers. Tie up belts.
- Empty the pockets and unfold the items.
- Turn inside out multilayered fabrics, wool and items with painted illustrations.
- Remove hard stains.
- Wash with a special detergent heavy soil stains.
- Be careful with the curtains. Remove the hooks or put the curtains in a washing bag or pillowcase.
- Do not wash in the appliance laundry without hems or with cuts. Use a washing bag to wash small and/or delicate items (e.g. underwired bras, belts, tights, etc. ).
- A very small load can cause balance problems with the spin phase. If this occurs, adjust manually the items in

the tub and start the spin phase again.

## 13.2 Stubborn stains

For some stains, water and detergent is not sufficient.

We recommend that you remove these stains before you put the items in the appliance.

Special stain removers are available. Use the special stain remover that is applicable to the type of stain and fabric.

## 13.3 Detergents and additives

- Only use detergents and additives specially made for washing machines:
  - powder detergents for all types of fabric,
  - powder detergents for delicate fabrics (40 °C max) and woollens,
  - liquid detergents, preferably for low temperature wash programmes (60 °C max) for all types of fabric, or special for woollens only.
- Do not mix different types of detergents.
- To help the environment, do not use more than the correct quantity of detergent.
- Obey the instructions that you find on the on packaging of these products.
- Use the correct products for the type and colour of the fabric, the

programme temperature and the level of soil.

- If your appliance has not the detergent dispenser with the flap device, add the liquid detergents with a dosing ball (supplied by the detergent's manufacturer).

### 13.4 Ecological hints

- Set a programme without the prewash phase to wash laundry with normal soil.
- Always start a washing programme with the maximum load of laundry.
- If necessary, use a stain remover when you set a programme with a low temperature.
- To use the correct quantity of the detergent, check the water hardness of your domestic system

### 13.5 Water hardness

If the water hardness in your area is high or moderate, we recommend that you use a water softener for washing machines. In areas where the water hardness is soft it is not necessary to use a water softener.

To know the water hardness in your area, contact your local water authority.

Use the correct quantity of the water softener. Obey the instructions that you find on the packaging of the product.

### 13.6 Drying hints

#### Prepare the drying cycle

- Open the water tap.
- Do a check if the connection of the drain hose is correct. Refer to installation chapter for more information.
- For the maximum laundry load of the drying programmes, refer to the drying programmes table.

### 13.7 Items not to dry





#### Do not set a drying programme for this laundry:

- Very delicate items.
- Synthetic curtains.
- Pieces of clothing with metal inserts.
- Nylon stockings.

- Quilts.
- Bed covers.
- Duvets.
- Anoraks.
- Sleeping bags
- Fabrics with residue of hair sprays, nail solvents or similar.
- Garments with foam-rubber or materials similar to foam-rubber.

### 13.8 Garment labels

When you dry the laundry, obey the indications on the labels of the manufacturers:

-  = The item can be tumble dried
-  = The drying cycle is at high temperature
-  = The drying cycle is at reduced temperature
-  = The item can not be tumble dried.

### 13.9 Drying cycle duration

The drying time can change depending on:

- speed of the last spin
- dryness level
- type of laundry
- weight of the load size

### 13.10 Additional drying

If, at the end of the drying programme, the laundry is still damp, set a short drying cycle again.



#### WARNING!

**To avoid creases of fabrics or shrinks of the clothing do not over dry the laundry.**

### 13.11 General Tips

Refer to the «Drying programmes» table to find the **average** drying times. The experience will help you to dry the laundry in a more correct way. Take note of the duration drying time of the cycles done before.



To avoid the static charge at the end of the drying cycle:

1. Use fabric conditioner in the washing cycle.
2. Use special fabric conditioner for tumble dryers.

When the drying programme is completed remove the laundry in a short time.

## 14. CARE AND CLEANING



### WARNING!

Refer to Safety chapters.

### 14.1 External cleaning

Clean the appliance only with soap and warm water. Fully dry all the surfaces.



### CAUTION!

Do not use alcohol, solvents or chemical products.

### 14.2 Descaling

If the water hardness in your area is high or moderate, we recommend that you use a water descaling product for washing machines.

Regularly examine the drum to prevent limescale and rust particles.

To remove rust particles use only special products for washing machine. Do this separately from the laundry wash.



Always obey the instructions that you find on the packaging of the product.

### 14.3 Maintenance wash

With the low temperature programmes it is possible that some detergent stays in the drum. Make regularly a maintenance wash. To do this:

- Remove the laundry from the drum.
- Set the cotton programme with the highest temperature with a small quantity of detergent.

### 14.4 Door seal

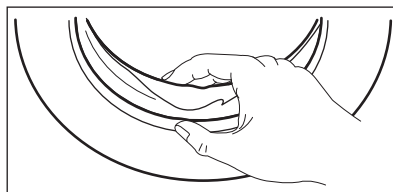

Regularly examine the seal and remove all objects from the inner part.

### 14.5 Cleaning the detergent dispenser

1.

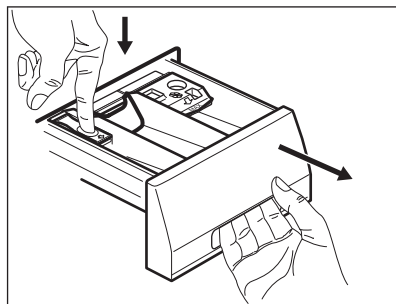

2.

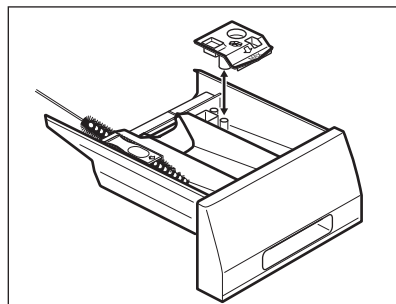

3.

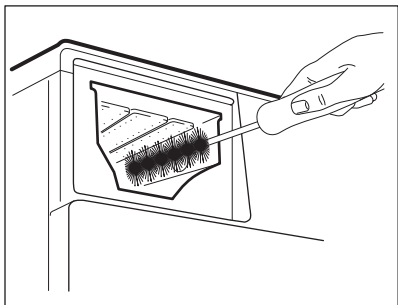

4.

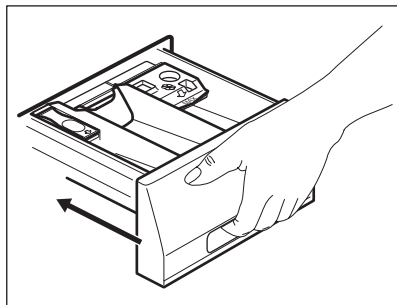

### 14.6 Cleaning the inlet hose and the valve filter

1.

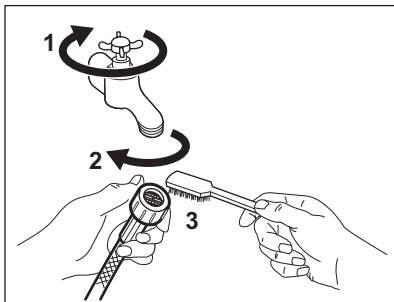

2.

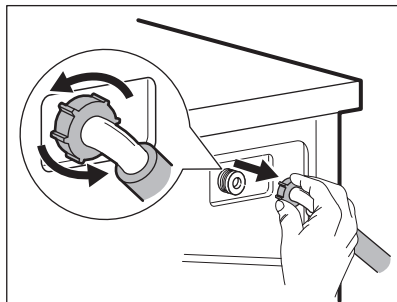

3.

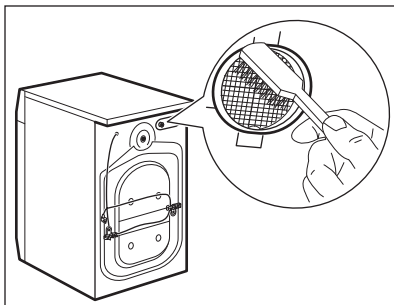

4.

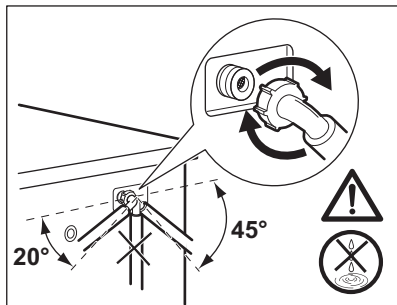

### 14.7 Cleaning the drain filter



#### **WARNING!**

Do not clean the drain filter if the water in the appliance is hot.

1.

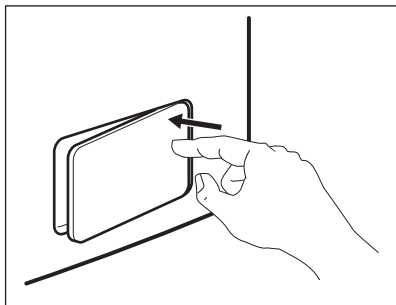

2.

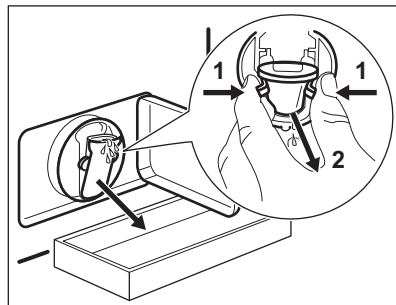

3.

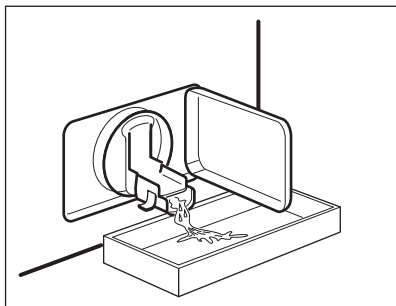

4.

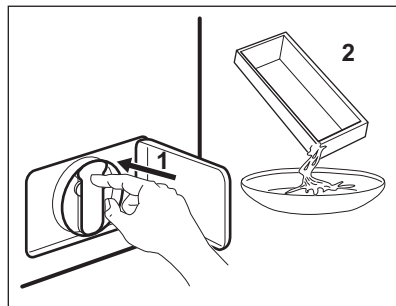

5.

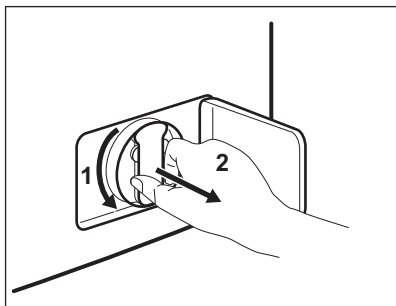

6.

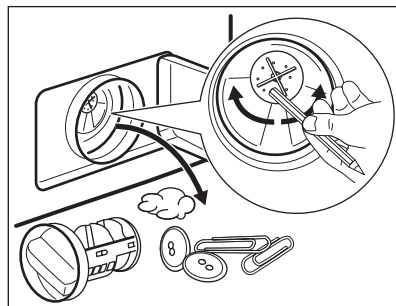

7.

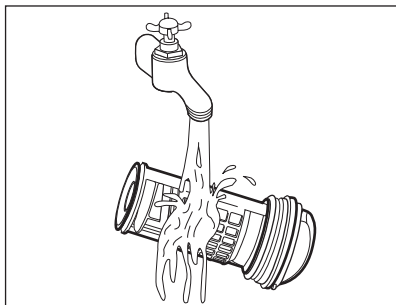

8.

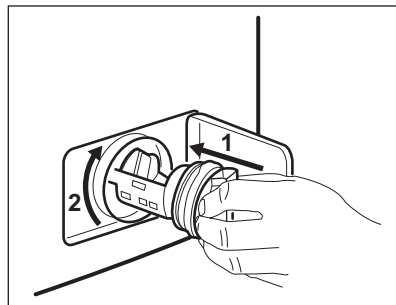

9.

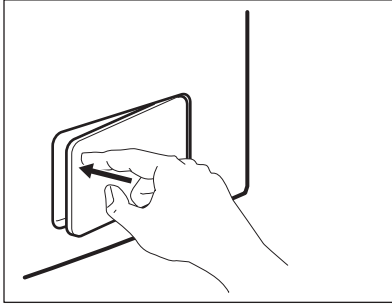

## 14.8 Emergency drain

Because of a malfunction, the appliance cannot drain the water.

If this occurs, do steps (1) through (9) of 'Cleaning the drain filter'. If necessary, clean the pump.

When you drain the water with the emergency drain procedure, you must activate again the drain system:

1. When you drain the water with the emergency drain procedure, you must activate again the drain system: Put 2 litres of water in the main wash compartment of the detergent dispenser.
2. Start the programme to drain the water

## 14.9 Frost precautions

If the appliance is installed in an area where the temperature can be less than

0° C, remove the remaining water from the inlet hose and the drain pump.

1. Disconnect the mains plug from the mains socket.
2. Close the water tap.
3. Put the two ends of the inlet hose in a container and let the water flow out of the hose.
4. Empty the drain pump. Refer to the emergency drain procedure.
5. When the drain pump is empty, install the inlet hose again.



### WARNING!

Make sure that the temperature is more than 0 °C before you use the appliance again. The manufacturer is not responsible for damages caused by low temperatures.

# 15. TROUBLESHOOTING



### WARNING!

Refer to Safety chapters.

## 15.1 Introduction

The start of the appliance does not occur or it stops during operation.

First try to find a solution to the problem (refer to the table). If not, contact the Authorised Service Centre.

**With some problems, the acoustic signals operate and the display shows an alarm code:**

- **E10** - The appliance does not fill with water properly.
- **E20** - The appliance does not drain the water.
- **E40** - The appliance door is open or not closed correctly. Please check the door!
- **E40** - The mains supply is unstable. Wait until the mains supply is stable.

- **E91** - No communication between electronic elements of the appliance. Switch off and switch on again.
- **EFO** - The anti-flood device is on. Disconnect the appliance and close the water tap. Contact the Authorised Service Centre.

**WARNING!**

Deactivate the appliance before you do the checks.

## 15.2 Possible failures

Problem	Possible solution
The programme does not start.	Make sure that the mains plug is connected to the mains socket.
	Make sure that the appliance door is closed.
	Make sure that there is not a damaged fuse in the fuse box.
	Make sure that the Start/Pause has been pressed.
	If the delay start is set, cancel the setting or wait for the end of countdown.
	Deactivate the Child Lock function if it is on.
The appliance does not fill with water properly.	Make sure that the water tap is open.
	Make sure that the pressure of the water supply is not too low. For this information, contact your local water authority.
	Make sure that the water tap is not clogged.
	Make sure that the filter of the inlet hose and the filter of the valve are not clogged. Refer to "Care and cleaning".
	Make sure that the inlet hose has no kinks or bends.
	Make sure that the connection of the water inlet hose is correct.
The appliance does not fill with water and drain immediately.	Make sure that the drain hose is in the correct position. The hose may be too low.
The appliance does not drain the water.	Make sure that the sink spigot is not clogged.
	Make sure that the drain hose has no kinks or bends.
	Make sure that the drain filter is not clogged. Clean the filter, if necessary. Refer to 'Care and cleaning'.
	Make sure that the connection of the drain hose is correct.
	Set the drain programme if you set a programme without drain phase.

Problem	Possible solution
	Set the drain programme if you set an option which ends with water in the tub.
The spin phase does not operate or the washing cycle lasts longer than usually.	Set the spin programme.
	Make sure that the drain filter is not clogged. Clean the filter, if necessary. Refer to 'Care and cleaning'.
	Adjust manually the items in the tub and start the spin phase again. This problem may be caused by balance problems.
There is water on the floor.	Make sure that the couplings of the water hoses are tight and there is not water leakages.
	Make sure that the drain hose have no damages.
	Make sure you use the correct detergent and the correct quantity of it.
You cannot open the appliance door.	Make sure that the washing programme is finished.
	Set the drain or the spin programme if there is water in the drum.
	Make sure that the appliance receives electrical power.
	This problem may be caused by a failure of the appliance. Contact the Authorised Service Centre. If you need to open the door, please read carefully «Emergency door opening».
The appliance makes an unusual noise.	Make sure the levelling of the appliance is correct. Refer to 'Installation'.
	Make sure that the packaging and/or the transit bolts are removed. Refer to 'Installation'.
	Add more laundry in the drum. The load may be too small.
The cycle is shorter than the time displayed.	The appliance calculates a new time according to the laundry load. See the 'Consumption Values' chapter.
The cycle is longer than the time displayed.	An unbalanced laundry load increases the duration time. This is a normal behaviour of the appliance.
The washing results are not satisfactory.	Increase the detergent quantity or use a different detergent.
	Use special products to remove the stubborn stains before you wash the laundry.
	Make sure that you set the correct temperature.

Problem	Possible solution
	Decrease the laundry load.
You cannot set an option.	Make sure that you press only the wanted button(s).
The appliance does not dry or does not dry correctly.	Turn the water tap on.
	Make sure the drain filter is not clogged.
	Reduce the laundry load.
	Make sure you have set the correct cycle. if necessary ,set again a short drying time.
The laundry is full of different colours fluff.	<p>The fabrics washed in the previous cycle released fluff of a different colour:</p> <ul style="list-style-type: none"> <li>• The drying phase helps to eliminate some fluff.</li> <li>• Clean the clothes with a fluff remover.</li> </ul> <p>In case of an excessive amount of fluff in the drum run the special programme to clean it (refer to "Fluff in the fabrics" for more details).</p>

After the check, activate the appliance. The programme continues from the point of interruption.

If the problem occurs again, contact the Authorised Service Centre.

If the display shows other alarm codes. Deactivate and activate the appliance. If the problem continues, contact the Authorised Service Centre.

## 15.3 Emergency door opening

In case of power failure or appliance failure the appliance door remains locked. The washing programme continues, when the power is restored. If the door remains locked in case of failure, it is possible to open it using the emergency unlock feature.

Before opening the door:



**CAUTION!**  
**Make sure that the water temperature and the laundry are not hot. Wait till they cool down, if necessary.**



**CAUTION!**  
**Make sure that the drum is not rotating. Wait till the drum stops rotating, if necessary.**



**Make sure that the water level inside the drum is not too high. Proceed with an emergency drain, if necessary (refer to «Emergency drain» in «Care and cleaning» chapter).**

To open the door, proceed as follows:

1. Press the button On/Off to switch the appliance off.
2. Disconnect the mains plug from the mains socket.
3. Open the filter flap.
4. Keep the emergency unlock trigger pulled downward and, at the same time, open the appliance door.

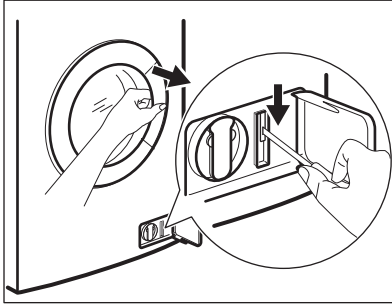

5. Take out the laundry and then close the appliance door.
6. Close the filter flap.

## 16. TECHNICAL DATA

Dimension	Width/ Height/ Depth/ Total depth	600 mm/850 mm/ 522 mm/ 540 mm
Electrical connection	Voltage Overall power Fuse Frequency	230-240 V 2200 W 13 A 50 Hz
Level of protection against ingress of solid particles and moisture ensured by the protective cover, except where the low voltage equipment has no protection against moisture		IPX4
Water supply pressure 1)	Minimum Maximum	0,5 bar (0,05 MPa) 8 bar (0,8 MPa)
Maximum wash load	Cotton	7 kg
Maximum dry load	Cotton Synthetics	4 kg 2 kg
Spin Speed	Maximum	1600 rpm

1) The appliance works correctly if the water pressure is not less than 0.05 MPa (0.5 bar). If you can not connect the water inlet hose to the cold water tap of the primary hydraulic system, connect it to your domestic cold water storage system. Make sure not to have more than a distance of 5.02 m (16.5 ft) between the appliance inlet hose and the bottom of the water storage tank.

## 17. ENVIRONMENT CONCERNS

Recycle the materials with the symbol . Put the packaging in applicable containers to recycle it. Help protect the environment and human health and to recycle waste of electrical and electronic appliances. Do not dispose appliances

marked with the symbol  with the household waste. Return the product to your local recycling facility or contact your municipal office.









[www.aeg.com/shop](http://www.aeg.com/shop)



132906831-A-062015



 **AEG**  
perfekt in form und funktion