

EWX147410W



EN Washer Dryer

User Manual



CONTENTS

1. SAFETY INFORMATION.....	3
2. SAFETY INSTRUCTIONS.....	5
3. PRODUCT DESCRIPTION.....	7
4. CONTROL PANEL.....	8
5. PROGRAMMES	10
6. CONSUMPTION VALUES.....	13
7. OPTIONS.....	14
8. SETTINGS.....	15
9. BEFORE FIRST USE.....	16
10. DAILY USE - WASHING ONLY.....	16
11. DAILY USE - DRYING ONLY.....	18
12. DAILY USE - WASHING & DRYING.....	19
13. HINTS AND TIPS.....	20
14. CARE AND CLEANING.....	22
15. TROUBLESHOOTING.....	26
16. INSTALLATION.....	29
17. TECHNICAL DATA.....	37

WE'RE THINKING OF YOU

Thank you for purchasing an Electrolux appliance. You've chosen a product that brings with it decades of professional experience and innovation. Ingenious and stylish, it has been designed with you in mind. So whenever you use it, you can be safe in the knowledge that you'll get great results every time. Welcome to Electrolux.

Visit our website for:



Get usage advice, brochures, trouble shooter, service information:
www.electrolux.com/webselfservice



Register your product for better service:
www.registerelectrolux.com



Buy Accessories, Consumables and Original spare parts for your appliance:
www.electrolux.com/shop

CUSTOMER CARE AND SERVICE

Always use original spare parts.

When contacting our Authorised Service Centre, ensure that you have the following data available: Model, PNC, Serial Number.

The information can be found on the rating plate.

 Warning / Caution-Safety information

 General information and tips

 Environmental information

Subject to change without notice.

1. SAFETY INFORMATION

Before the installation and use of the appliance, carefully read the supplied instructions. The manufacturer is not responsible for any injuries or damages that are the result of incorrect installation or usage. Always keep the instructions in a safe and accessible location for future reference.

1.1 Children and vulnerable people safety



WARNING!

Risk of suffocation, injury or permanent disability.

- This appliance can be used by children aged 8 years and above and by persons with reduced capabilities provided that they have been given instruction and/or supervision regarding the safe use of the appliance and understand the potential hazards involved.
- Do not let children play with the appliance.
- Children under 3 years of age should be kept away from the appliance unless continuously supervised.
- Keep all packaging away from children and dispose of it appropriately.
- Keep detergents away from children.
- Keep children and pets away from the appliance door when it is open.
- If the appliance has a child safety device, this should be activated.
- Children shall not carry out cleaning and user maintenance of the appliance without supervision.

1.2 General Safety

- Do not change the specification of this appliance.
- The appliance shall be installed as a freestanding product or below the kitchen worktop if space margins permit.

- Do not install the appliance behind a lockable door, a sliding door or a door with a hinge on the opposite side, that would prevent the appliance door from being fully opened.
- Connect the mains plug to the mains socket only at the end of the installation process. Make sure that the mains plug is accessible after installation..
- The ventilation opening in the base (if applicable) must not be covered by a carpet, mat, or any floor covering.
- Ensure good air ventilation in the located room to avoid the back flow of gases into the room from appliances burning gas or other fuels, including open fires.
- Exhaust air must not be discharged into a flue which is used for exhausting fumes from any appliances burning gas or other fuels.
- The operating water pressure at the water entry point from the outlet connection must be between 0.5 bar (0.05 MPa) and 8 bar (0.8 MPa).
- Do not exceed the maximum load of 7 kg (refer to the "Programme chart" chapter).
- The appliance must be connected to the water mains using the new supplied hose sets, or other new hose sets supplied by the Authorised Service Centre.
- Old hose sets must not be reused.
- If the mains power supply cable is damaged, it must be replaced by the manufacturer, its Authorised Service Centre or similarly qualified persons to avoid an electrical hazard.
- Wipe away lint or packaging debris that has accumulated around the appliance.
- Items that have been soiled with substances such as vegetable or mineral oil, acetone, alcohol, petrol, kerosene, spot removers, turpentine, waxes and wax removers should be washed separately with an extra amount of detergent before being dried in the washer dryer.

- Do not use the appliance if items have been soiled with industrial chemicals.
- Do not dry unwashed items in the wash dryer.
- Items such as foam rubber (latex foam), shower caps, waterproof textiles, and rubber backed articles and clothes, or pillows fitted with foam rubber pads should not be dried in the washer dryer.
- Fabric softeners, or similar products, should only be used as specified by the product manufacturer's instructions.
- Remove all objects from items that could be a source of fire ignition such as lighters or matches.
- Never stop the washer dryer before the end of the drying cycle unless all items are quickly removed and separated so that residual heat can dissipate.
- The final part of the washer dryer cycle takes place without heat (cool down cycle) to ensure that items reach a temperature that will not cause damage to them.
- Do not use high pressure water sprays and/or steam to clean the appliance.
- Clean the appliance with a moist cloth. Use only neutral, detergents. Do not use abrasive products, abrasive cleaning pads, solvents or metal objects.
- Before any maintenance operation, deactivate the appliance and disconnect the mains plug from the socket.

2. SAFETY INSTRUCTIONS

2.1 Installation

- Follow the installation instruction supplied with the appliance.
- Do not install or use the appliance where the temperature can be less than 0°C or where it is exposed to the weather.
- Always keep the appliance vertical when being moved.
- Make sure that there is air circulation between the appliance and the floor.
- Remove all the packaging and the transit bolts.
- The floor area where the appliance is to be installed must be flat, stable, heat resistant and clean.
- Keep the transit bolts in a safe place. If the appliance is to be moved in future they must be reattached to lock the drum to prevent internal damage.
- Always take care when moving the appliance as it is heavy. Always use safety gloves and enclosed footwear.

- Do not install or use a damaged appliance.
- Do not install the appliance where the appliance door cannot be fully opened.
- Adjust the feet to have the necessary space between the appliance and the flooring.
- When the appliance is in its permanent position, check that it is fully level with the aid of a spirit level. If it is not, adjust the feet accordingly.

2.2 Electrical Connection



WARNING!

Risk of fire and electrical shock.

- The appliance must be earthed.
- Always use a correctly installed shockproof socket.
- Do not use multi-plug adapters and extension cables.
- Do not pull the mains cable to disconnect the appliance. Always pull the mains plug.
- Do not touch the mains cable or the mains plug with wet hands.
- This appliance complies with the E.E.C. Directives.

2.3 Water Connection

- Do not cause damage to the water hoses.
- Before connection to new pipes, pipes not used for a long time, where repair work has been carried out or new devices fitted (water meters, etc.), let the water flow until it is clean and clear.
- Ensure that there are no visible water leaks during and after the first use of the appliance.

2.4 Use



WARNING!

Risk of injury, electrical shock, fire, burns or damage to the appliance.

- This appliance is for household use only.
- Do not put flammable products or items that are wet with flammable products in, near or on the appliance.
- Do not touch the glass door while a programme is in operation. The glass can get hot.
- Do not dry damaged (torn, frayed) items that contain padding or fillings.
- If laundry has been washed with a stain remover, carry out an additional rinse cycle before starting a drying cycle.
- Make sure that all metal objects are removed from the laundry.
- Only dry fabrics that are suitable to dry in the washer dryer. Follow the cleaning instruction on the item label.
- Plastic items are not heat resistant.
 - If a detergent ball is used, remove it before starting a drying programme.
 - Do not use a detergent ball if setting a non-stop programme.



WARNING!

Risk of injury or damage to the appliance.

- Do not sit or stand on the open door.
- Do not dry dripping wet clothes in the appliance.

2.5 Disposal

- Disconnect the appliance from the mains electrical and water supplies.
- Cut off the mains electrical cable close to the appliance and dispose of it.
- Remove the door catch to prevent children or pets from becoming trapped in the drum.
- Dispose of the appliance in accordance with local requirements for the disposal of Waste Electrical and Electronic Equipment (WEEE).

3. PRODUCT DESCRIPTION

3.1 Appliance overview

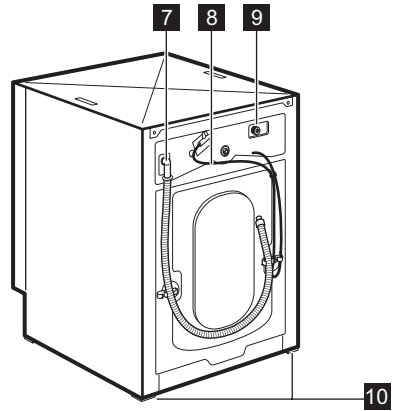
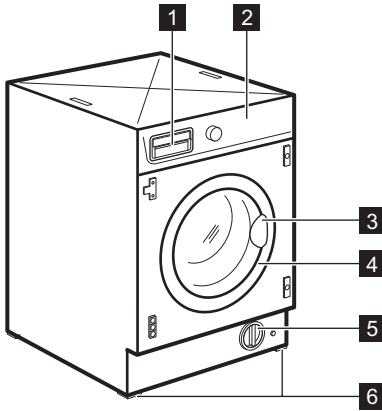

- 1** Detergent dispenser
- 2** Control panel
- 3** Door handle
- 4** Rating plate
- 5** Drain pump filter
- 6** Feet for levelling the appliance
- 7** Water drain hose
- 8** Mains cable
- 9** Water inlet hose connection
- 10** Feet for levelling the appliance

Turn the device clockwise, until the groove is horizontal.
You cannot close the door.

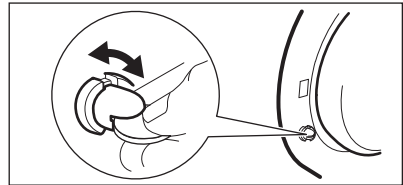

To close the door, turn the device anticlockwise until the groove is vertical.

3.2 How to activate the child safety device

This device prevents children or pets from being closed in the drum.

4. CONTROL PANEL

4.1 Control panel description

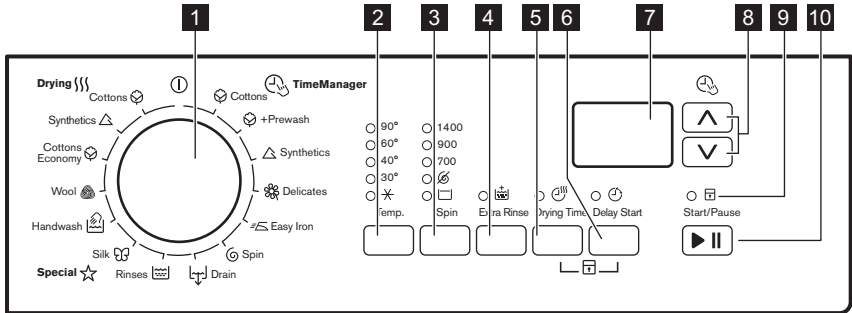





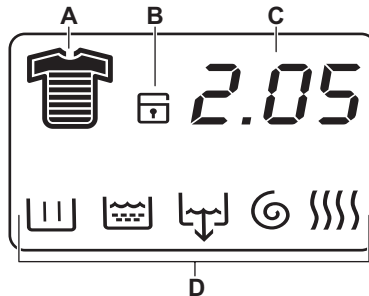

- | | |
|--|--|
| <p>1 Programme knob</p> <p>2 Temperature button - Temperature</p> <p>Cold position ✖</p> <p>3 Spin reduction button - Spin</p> <ul style="list-style-type: none"> • No spin function • Rinse hold function <p>4 Extra rinse button - Extra Rinse</p> | <p>5 Drying time button - Drying time</p> <p>6 Delay start button - Delay Start</p> <p>7 Display</p> <p>8 Time Manager buttons</p> <p>9 Door locked indicator</p> <p>10 Start/Pause button - Start/Pause</p> |
|--|--|

4.2 Display



The display shows the following information:





A Soil degree indicators:

	Intensive
	Normal
	Daily
	Light
	Quick
	Quick
	Refresh
	Super Refresh

When you select a programme, the display shows the indicator of the soil degree automatically proposed by the appliance.

B  Child safety lock (see chapter «Settings»).**C** Digit area:





- **Duration of the selected programme**
After you select a programme, the duration is displayed in hours and minutes (for example *2.05*). The duration is calculated automatically on the basis of the maximum recommended load for each type of fabric. After the programme start, the time remaining is updated every minute.
- **Selected drying time**
After you select the drying programme, the drying time is displayed in minutes or in hours and minutes. After the programme start, the time remaining is updated every minute.
- **Delayed start**
The selected delay appears for few seconds, then the display shows the duration of the selected programme again.
- **Alarm codes**
In the event of operating problems, some alarm codes can be displayed, for example *E20* (see chapter «Troubleshooting»).
- **Incorrect option selection**
If you set an option not compatible with the selected wash programme, the message *E r r* shows up for a few seconds and the red indicator of button Start/Pause starts flashing.
- **End of programme**
When the programme has finished, the flashing value *0.00* is displayed. The indicator of Start/Pause button goes out.
If the indicator  goes off, you can open the door.









D Washing programme phase indicators:	
	Wash
	Rinses
	Drain
	Spin
	Drying

By selecting the wash programme, the washing programme indicators corresponding to the various phases making up the programme are shown. After you have pressed the Start/Pause button, only the indicator of the running phase stays on.

5. PROGRAMMES

5.1 Programme Chart

Programme Temperature range	Maximum load Reduced load ¹⁾ Maximum spin speed	Programme description (Type of load and soil level)
Washing programmes		
 Cottons 90°C - ✖ (Cold)	7 kg 3.5 kg 1400 rpm	White cotton and coloured cotton. Normal soil and light soil.
 Cottons + Prewash 90°C - ✖ (Cold)	7 kg 3.5 kg 1400 rpm	White cotton and coloured cotton. Heavy soil and normal soil.
 Synthetics 60°C - ✖ (Cold)	3 kg 1.5 kg 900 rpm	Synthetic items or mixed fabric items. Normal soil.
 Delicates 40°C - ✖ (Cold)	3 kg 1.5 kg 700 rpm	Delicate fabrics such as acrylics, viscose, polyester items. Normal soil.
 Easy Iron 60°C - ✖ (Cold)	1.5 kg 900 rpm	Synthetic items requiring a gentle wash. Normal and light soil. ²⁾

Programme Temperature range	Maximum load Reduced load ¹⁾ Maximum spin speed	Programme description (Type of load and soil level)
 Spin	7 kg 1400 rpm	To spin the laundry and to drain the water in the drum. All fabrics, except woollens and delicate fabrics.
 Drain	7 kg	To drain the water in the drum. All fabrics.
 Rinses	7 kg 1400 rpm	To rinse and spin the laundry. All fabrics , except woollens and very delicate fabrics. Reduce the spin speed accordingly to the type of laundry.
 Silk 30°C	1 kg 700 rpm	Special programme for silk and mixed synthetic items.
 Handwash 40°C - ❄️ (Cold)	2 kg 900 rpm	Machine washable wool, hand washable wool and delicate fabrics with «hand washing» care symbol. ³⁾
 Wool 40°C - ❄️ (Cold)	2 kg 900 rpm	Machine washable wool, hand washable wool and delicate fabrics with «hand washing» care symbol. ³⁾
 Cottons Economy 90°C - 40°C	7 kg 1400 rpm	White cotton and fast-coloured cotton. Normal soil. The energy consumption decreases and the time of the washing programme is extended. This programme at 60 °C is the reference programme for energy label data, in compliance with UAE. S 5010 2:2013.
Drying programmes		
 Drying -Synthetics	2 kg	Drying programme for synthetic items.

















Programme Temperature range	Maximum load Reduced load ¹⁾ Maximum spin speed	Programme description (Type of load and soil level)
 Cottons	4 kg	Drying programme for cotton items .

1) If you select the Super Quick, Refresh or Super Refresh option by pressing buttons Time Manager, we recommend that you reduce the maximum load as indicated in the programmes for cottons, synthetics and delicates. Full loading is possible however with somewhat reduced cleaning results.

2) To reduce creasing, this cycle regulates the water temperature and performs a soft wash and spin phase. The appliance adds some rinses.

3) During this cycle the drum rotates slowly to ensure a gentle wash. It can seem that the drum doesn't rotate or doesn't rotate properly, but this is normal for this programme.

Programme options compatibility

Programme					
Cottons 	■	■	■	■	■
Cottons + Prewash 	■	■	■	■	■
Synthetics 	■	■	■	■	■
Delicates 		■	■	■	■
Easy Iron 	■	■	■	■	
Spin ¹⁾ 	■				
Drain 					
Rinses 	■	■	■	■	
Silk 		■	■		
Handwash 	■	■	■		
Wool 	■	■	■		
Cottons Economy 	■	■	■	■	

1) Set the spin speed. Make sure it is suitable for the type of fabric being washed. If you set the No Spin option then only the drain phase is available.

5.2 Programmes for timed drying

Dryness Level	Type of fabric	Load (kg)	Spin speed (rpm)	Suggested duration (mins)
Extra Dry For towelling materials	Cottons and Linen (bathrobes, bath towels, etc)	4	1400	215 - 220
		3	1400	160 - 180
		1.5	1400	95 - 105
Cupboard Dry¹⁾ For items to be stored	Cottons and Linen (bathrobes, bath towels, etc)	4	1400	205 - 210
		3	1400	150 - 170
		1.5	1400	85 - 95
Cupboard Dry For items to be stored	Synthetics and mixed fabrics (jumpers, blouses, underwear, household linen)	2	900	90 - 100
		1	900	55 - 65
Iron Dry Suitable for ironing	Cottons and Linen (sheets, tablecloths, shirts, etc)	4	1400	140 - 150
		3	1400	90 - 100
		1.5	1400	60 - 70

¹⁾ In compliance with **UAE.S 5010 2:2013**, the cotton reference programme for the data entered in the Energy Label must be tested dividing the maximum washing load by two equal parts and drying with DRYING TIME each of them.

6. CONSUMPTION VALUES



The data in this table are approximate. Different variables can affect the data: the quantity and type of laundry, the water and ambient temperature.

Programmes	Load (kg)	Energy consumption (kWh)	Water consumption (litre)	Approximate programme duration (minutes)
Cottons 60°C	7	1.35	67	150
Cottons Economy 60°C ¹⁾	7	1.05	57	219
Cottons 40°C	7	0.85	67	140
Synthetics 40°C	3	0.55	42	90
Delicates 40°C	3	0.55	63	65
Wool/Handwash 30°C	2	0.25	55	60

¹⁾ This programme at 60 °C is the reference programme for energy label data, in compliance with UAE. S 5010 2:2013.

7. OPTIONS

7.1 Programme knob

This knob allows you to select a programme, to reset a programme and/or to switch the appliance on/off .

The knob can be turned either clockwise or counterclockwise.

At the end of the programme, turn the knob to position On/Off to deactivate the appliance.

7.2 Temperature

Press this button to increase or decrease the default washing temperature.

If you set the position , the appliance performs the washing with cold water.

The indicator of the set temperature illuminates.

7.3 Spin

Press this button to increase or decrease the default spin speed or to select the additional spin options.

The indicator of the set speed illuminates.

Additional spin options:

NO SPIN

- Set this option to remove all spin phases.
- Set it for extremely delicate fabrics.
- The rinse phase uses more water for some washing programmes.

RINSE HOLD

- Set this option to prevent the laundry from creases.
- The washing programme stops with the water in the drum. The drum turns regularly to prevent the laundry creases.
- The door stays locked. You must drain the water before opening the door.



To drain the water refer to 'At the end of the programme'.

7.4 Extra Rinse

Press this button to add some rinses to the washing programme.

Use this option for persons allergic to detergents and in areas where the water is soft.

The related indicator comes on.

7.5 Drying time

Press this button to set the time for the fabrics you have to dry. The display shows the set value.

For Cottons you can select a drying time from 10 minutes to 250 minutes (4.10 in the digit area).

For Synthetics you can select a drying time from 10 minutes to 130 minutes (2.10 in the digit area).

Each time you press the button, the time value increases by 5 minutes.



You cannot set all time values for different types of fabrics.

7.6 Delay Start

Press this button to delay the start of the programme by 30 min - 60 min - 90 min, 2 hours and then by 1 hour up to a maximum of 20 hour.

The button indicator illuminates. The display shows the selected delay value.

7.7 Time Manager

Press this button to increase or decrease the programme duration proposed by the appliance.

The indicator of the chosen degree will appear on the display.

This option is available only with Cottons, Synthetics and Delicate programmes.

Washing cycle	Soil level	Type of fabrics
Intensive		Heavy soiled items
Normal		Normal soiled items
Daily		Daily soiled items
Light		Slightly soiled items
Quick		Very slightly soiled items
Super Quick ¹⁾		Items used or worn for a short time
Refresh ¹⁾		To refresh items only
Super Refresh ¹⁾		To refresh few items only

¹⁾ It is recommended to reduce the load sizes.

²⁾ When you select this option the relevant indicator appears just for a while and then it disappears immediately.

8. SETTINGS

8.1 Acoustic signals

The acoustic signals sound when:

- The programme is completed.
- The appliance has a malfunction.

To **deactivate/activate** the acoustic signals, press button Extra Rinse and button Drying Time at the same time for about 6 seconds.



If you deactivate the acoustic signals, they continue operate when the appliance has a malfunction.

8.2 Child Lock function

With this function you can leave the appliance unattended and prevent that the children play with the control panel.



The availability of the soil degree changes according to the type of fabric and temperature.

7.8 Door locked indicator

The indicator illuminates when the programme starts and indicates when the door can be opened:

- The indicator is on: the door **cannot** be opened.
The appliance is working or has stopped with water left in the tub.
- The indicator flashes: the door is opening in some minutes.
The programme is finished or the water has been emptied out.
- The indicator is off: the door can be opened.

7.9 Start/Pause

Press this button to start or to interrupt the selected programme.

- To **activate/deactivate** this function, press Delay Start and Drying Time at the same time until the indicator **comes on/goes off** in the display.

You can activate this option in two ways:

- After you press Start/Pause: the options and the programme knob are locked.
- Before you press Start/Pause : the appliance cannot start.

9. BEFORE FIRST USE

1. Put 2 litre of water in the detergent compartment for washing phase.
This activates the drain system.
2. Put a small quantity of detergent in the compartment for washing phase.
3. Set and start a programme for cotton at the highest temperature without laundry.
This removes all possible dirt from the drum and the tub.

10. DAILY USE - WASHING ONLY

10.1 Loading the laundry

1. Open the appliance door
2. Put the laundry in the drum, one item at a time.
3. Shake the items before you put them in the appliance.

Make sure not to put too much laundry in the drum.

4. Close the door firmly.

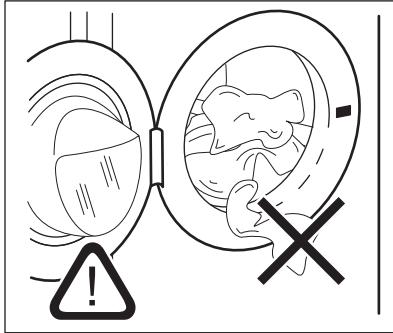

CAUTION!

Make sure that no laundry stays between the seal and the door. There is a risk of water leakage or damage to the laundry.

10.2 Using detergent and additives

1. Measure out the detergent and the fabric conditioner.
2. Put the detergent and the fabric conditioner into the compartments.
3. Carefully close the detergent drawer

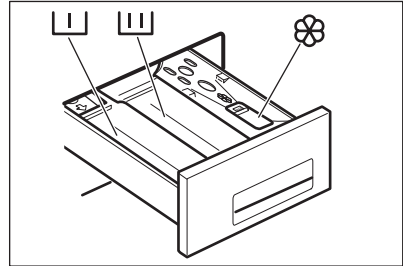

10.3 Detergent compartments



CAUTION!

Use only specified detergents for washing machine.



Always obey the instructions that you find on the packaging of the detergent products.



Detergent compartment for pre-wash phase.



Detergent compartment for washing phase.



Compartment for liquid additives (fabric conditioner, starch).

10.4 Switching the appliance on and setting a programme

1. Turn the programme knob to switch the appliance on and to set the required programme:

- The display shows the default level of Time Manager, the programme duration and the programme phases indicators of the selected programme.
 - The indicator of Start/Pause button flashes in green.
2. If necessary, change the temperature, the spin speed, the cycle duration or add available options. When you activate an option, the related indicator comes on.

i If you set something not compatible with the selected programme, the display shows the message . The Start/Pause button indicator flashes in red 3 times.

10.5 Starting a programme with the delay start

1. Press the Delay Start button repeatedly until the display shows the delay you want to set. The related indicator illuminates.

The selected delay time value (up to 20 hours) will appear on the display a few seconds, then the duration of the programme will appear again.

2. Press the Start/Pause button.
 - The door is locked and the indicator  is on.
 - The appliance starts the countdown.
 - When the countdown is completed, the programme starts automatically.

i You can cancel or change the set of the Delay Start before you press the Start/Pause button. After pressing the Start/Pause button you can only cancel the Delay Start.

To cancel the Delay Start:

- a. Press the Start/Pause button to set the appliance to pause. The related indicator flashes.
- b. Press the Delay Start button until the display shows . Press the Start/Pause button again to start the programme immediately.

i The Delay Start can not be selected with the draining programme.

10.6 Starting a programme without the delay start

Press the Start/Pause button.

- The green Start/Pause indicator stops flashing and stays on.
- The programme starts, the door locks, the indicator  illuminates and stays on.
- The programme time on the display decreases with steps of one minute.

i The drain pump can operate for a short time at the beginning of the washing cycle.

10.7 Interrupting a programme and changing the options

You can change only some options before the programme carries them out.

1. Press the Start/Pause button to interrupt the running programme. The related indicator flashes.
2. Change the options (if you wish to change the Time Manager option, you must cancel the running programme and make your selection again).
3. Press the Start/Pause button again. The programme continues.

10.8 Cancelling a running programme

1. Turn the programme knob to On/Off position to cancel the programme. The appliance is deactivated.

- Now, you can set a new washing programme and the available options.



Before starting the new programme the appliance could drain the water. In this case, make sure that the detergent is still in the detergent compartment; if not, fill the detergent again.

10.9 Opening the door

While a programme is running or during the Delay Start, the appliance door is locked. The indicator  is on.



CAUTION!

If the temperature and level of the water in the drum are too high and the drum still rotates, you cannot open the door.

To open the door during the first minutes of the cycle or when the Delay Start operates:

- Press the Start/Pause button to pause the appliance.
- Wait until the indicator  goes off.
- You can open the door.
- Close the door and press the Start/Pause button again.
The programme (or the Delay Start) continues.

10.10 At the end of the programme

- The appliance stops automatically. Some acoustic signals sound (if they are activated).
- In the display the value **0.00** come on. The Start/Pause indicator goes off.

- When the door lock indicator  goes off, you can open the door.
- Remove the laundry from the appliance. Make sure that the drum is empty. Close the water tap.
- Turn the programme knob to On/Off position to deactivate the appliance.
- Keep the door ajar, to prevent the mildew and odours.

The washing programme is completed, but there is water in the drum:

- The drum turns regularly to prevent the creases in the laundry.
- The door lock indicator  is on. The door stays locked.
- You must drain the water to open the door.

To drain the water:

- Turn the programme knob to On/Off position and then select a spinning or draining programme.
- Press the Start/Pause button. If necessary, decrease the spin speed. The appliance spins and drains or only drains.
- When the programme is completed and the indicator  goes off, you can open the door.
- Turn the programme knob to On/Off position to deactivate the appliance.

10.11 Stand-by

Once the programme has finished, after a few minutes the energy saving system will be enabled.

The brightness of the display is reduced.

By pressing any button the appliance will come out of the energy saving status.

11. DAILY USE - DRYING ONLY



WARNING!

Refer to Safety chapters.

11.1 Timed drying



WARNING!
Make sure that the water tap is open.

The recommended load size is 4 kg for cottons and 2 kg for synthetic items.

1. Load the laundry one item at a time.
2. Turn the programme knob in the Drying sector to the programme suitable to the items to dry (cotton or synthetic).



To have a good drying performance **do not** exceed the maximum drying loads recommended in the user manual.

Do not set a spin speed lower than the automatic speed proposed by the selected programme.

3. Press the Drying time button to set the desired drying time (see the « Programmes for timed drying» paragraph). Every time you press this button the drying time increases by 5 minutes.



On the display the programme time will automatically increase by some minutes. This is quite normal.

4. Press Start/Pause button to start the programme.

The display shows the drying indicator  and updates regularly the drying time value.

The indicator  illuminates. The door is locked.



If you set only 10 minutes of drying phase, the appliance performs only a cooling phase.

If the laundry is not sufficiently dry, set a short drying time again.

11.2 End of the drying programme

The appliance stops automatically.

- The acoustic signals sound (if they are active). In the display the value **0.00** comes on.
- The Start/Pause indicator goes off.
- The last minutes of the drying cycle the appliance performs a cooling and anti-crease phase. Through this time the door is still locked. The display keeps showing the value **0.00**. If you wish to open the door before or during the anti-crease phase or to interrupt it, press any button or turn the programme selector dial to any programme position.

When the door locked indicator  goes off, you can open the door.

1. Turn the selector dial to On/Off position to deactivate the appliance.
2. Remove the laundry from the appliance.

Make sure that the drum is empty.

3. Keep the door ajar, to prevent mildew and odours.
4. Close the water tap.

12. DAILY USE - WASHING & DRYING



WARNING!
Refer to Safety chapters.

12.1 Drying setting



WARNING!
Make sure that the water tap is open.



CAUTION!
Do not use a dosing device/ ball when carrying out a washing and drying programme.

The recommended load size is 4 kg for cottons and 2 kg for synthetic items.

12.2 Non-Stop programme - Washing and Timed Drying

1. Load the laundry one item at a time. Turn the programme knob to the set washing programme.
2. Add detergent and fabric softener.
3. Press the relevant buttons to select the required options.



To have a good drying performance do not exceed the maximum drying loads recommended in the user manual. Do not set a spin speed lower than the automatic speed proposed by the selected programme.

4. Press Tempo di asciugatura button to set the drying time. Every time you press this button the drying time increases by 5 minutes.

The display shows the whole duration of the washing and the selected drying cycles.



On the display the programme time will automatically increase by some minutes. This is quite normal.

The display shows the drying indicator and updates regularly the drying time value.

5. Press Start/Pause button to start the programme.

The indicator  illuminates. The door is locked.



If you set only 10 minutes as drying phase, the appliance performs only a cooling phase.

12.3 End of the programme

The appliance stops automatically. The acoustic signals sound (if they are active).

For more information see 'At the end of the drying programme' of the previous chapter.

1. Turn the programme knob to the On/Off position to deactivate the appliance.
2. Remove the laundry from the appliance.

Make sure that the drum is empty.

3. Keep the door ajar, to prevent mildew and odours.
4. Close the water tap.

12.4 Fluff in the fabrics

During the washing and/or drying phase, some types of fabric, (sponge, wool, sweatshirt) could release fluff.

The released fluff could stick to the fabrics during the next cycle.

To prevent the fluff in your laundry, we recommend that you:

- Do not wash dark fabrics after you have washed and dried light coloured fabrics (new sponge, wool, sweatshirt) and the contrary.
- Line dry this type of fabrics at open air when they are washed the first time.
- Clean the drain filter.
- After the drying phase, clean the empty drum, the gasket and the door with a wet cloth.

13. HINTS AND TIPS



WARNING!
Refer to Safety chapters.

13.1 The laundry load

- Divide the laundry in: white, coloured, synthetics, delicates and wool.

- Obey the washing instructions that are on the laundry care labels.
- Do not wash white and coloured items together.
- Some coloured items can discolour with the first wash. We recommend that you wash them separately for the first times.

- Button up pillowcases, close zippers, hooks and poppers. Tie up belts.
- Empty the pockets and unfold the items.
- Turn multilayered fabrics, wool and items with painted illustrations inside out.
- Remove hard stains.
- Wash heavy soil stains with a special detergent.
- Be careful with the curtains. Remove the hooks or put the curtains in a washing bag or pillowcase.
- Do not wash laundry without hems or with cuts. Use a washing bag to wash small and/or delicate items (e.g. underwired bras, belts, tights, etc.).
- A very small load can cause balance problems with the spin phase. If this occurs, adjust manually the items in the tub and start the spin phase again.

13.2 Stubborn stains

For some stains, water and detergent is not sufficient.

We recommend that you pre-treat these stains before you put the items in the appliance.

Special stain removers are available. Use the special stain remover that is applicable to the type of stain and fabric.

13.3 Detergents and additives

- Only use detergents and additives specially made for washing machines:
 - powder detergents for all types of fabric,
 - powder detergents for delicate fabrics (40 °C max) and woollens,
 - liquid detergents, preferably for low temperature wash programmes (60 °C max) for all types of fabric, or special for woollens only.
- Do not mix different types of detergents.
- To help the environment, do not use more than the correct quantity of detergent.
- Obey the instructions that you find on the on packaging of these products.

- Use the correct products for the type and colour of the fabric, the programme temperature and the level of soil.
- If your appliance does not have the detergent dispenser with the flap device, add the liquid detergents with a dosing ball (supplied by the detergent's manufacturer).

13.4 Ecological hints

- Set a programme without the prewash phase to wash laundry with normal soil.
- Always start a washing programme with the maximum load of laundry allowed.
- If necessary, use a stain remover when you set a programme with a low temperature.
- To use the correct quantity of detergent, check the water hardness of your domestic system. Refer to "Water hardness".

13.5 Water hardness

If the water hardness in your area is high or moderate, we recommend that you use a water softener for washing machines. In areas where the water hardness is soft it is not necessary to use a water softener.

To know the water hardness in your area, contact your local water authority.

Use the correct quantity of the water softener. Obey the instructions that you find on the packaging of the product.

13.6 Drying hints

Prepare the drying cycle

- Open the water tap.
- Check if the drain hose is connected properly. Refer to installation chapter for more information.
- For the maximum laundry load of the drying programmes, refer to the drying programmes table.





13.7 Items not suitable for drying

Do not set a drying programme for this laundry:

- Very delicate items.
- Synthetic curtains.
- Pieces of clothing with metal inserts.
- Nylon stockings.
- Quilts.
- Bed covers.
- Duvets.
- Anoraks.
- Sleeping bags.
- Fabrics with residue of hair sprays, nail solvents or similar.
- Garments with foam-rubber or materials similar to foam-rubber.

13.8 Garment labels

When you dry the laundry, obey the indications on the labels of the manufacturers:

-  = The item can be tumble dried
-  = The drying cycle is at high temperature
-  = The drying cycle is at reduced temperature
-  = The item can not be tumble dried.

13.9 Drying cycle duration

The drying time can change depending on:

- speed of the last spin
- dryness level
- type of laundry
- weight of the load

13.10 Additional drying

If, at the end of the drying programme, the laundry is still damp, set a short drying cycle again.



WARNING!
To avoid creasing and shrinkage do not overdry the laundry.

13.11 General Tips

Refer to the «Drying programmes» table to find the **average** drying times. Experience will help you to dry the laundry better. Take note of the duration of the cycles done before.

To avoid the static charge at the end of the drying cycle:

1. Use fabric conditioner in the washing cycle.
2. Use special fabric conditioner for tumble dryers.

When the drying programme is completed remove the laundry promptly.

14. CARE AND CLEANING



WARNING!
Refer to Safety chapters.

14.1 External cleaning

Clean the appliance with soap and warm water only. Fully dry all the surfaces.



CAUTION!
Do not use alcohol, solvents or chemical products.

14.2 Descaling

If the water hardness in your area is high or moderate, we recommend that you use a water descaling product for washing machines.

Regularly examine the drum to prevent limescale and rust particles.

To remove rust particles use only special products for washing machines. Do this separately from the laundry wash.

- i** Always obey the instructions that you find on the packaging of the product.

14.3 Maintenance wash

With the low temperature programmes it is possible that some detergent stays in the drum. Perform a maintenance wash regularly. To do this:

- Remove all laundry from the drum.
- Select the cotton programme with the highest temperature with a small quantity of detergent.

14.5 Cleaning the detergent dispenser

1.

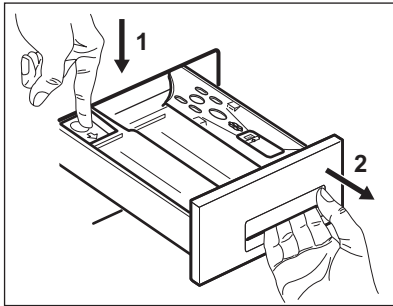

2.

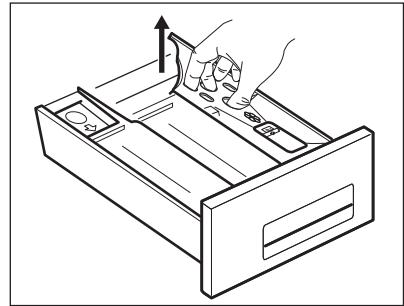

3.

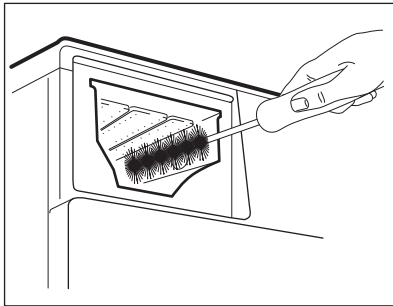

4.

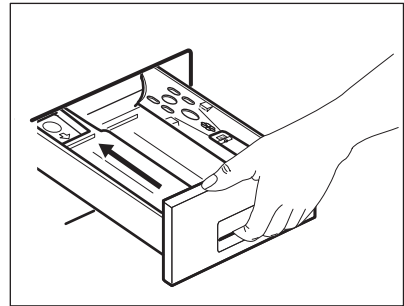

14.6 Cleaning the drain filter

The pump should be inspected regularly and particularly if:

- The appliance does not empty and/or spin.
- The appliance makes an unusual noise during draining due to objects

14.4 Door seal

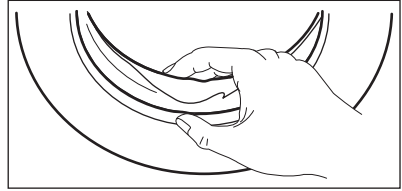

Regularly examine the seal and remove all objects from the inner part.

such as safety pins, coins etc. blocking the pump.

- A problem with water draining is detected (see chapter "Troubleshooting" for more details).



WARNING!

Before unscrewing the pump cover, switch the appliance off and remove the mains plug from the socket.

To clean the drain filter:



WARNING!

When the appliance is in use and depending on the programme selected there can be hot water in the filter. Never remove the filter cover during a wash cycle, always wait until the appliance has finished the cycle, and is empty. When refitting the filter cover, ensure it is securely re-tightened so as to stop leaks and young children being able to remove it.

1. Unplug the appliance.
2. If it is necessary, wait until the water has cooled down

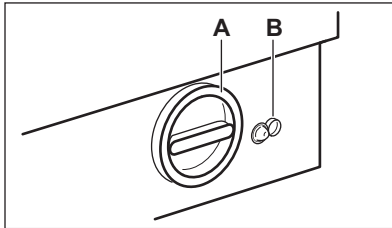

3. Place a container close to the pump to collect any spillage.

A = Cover filter.

B = Emergency emptying hose.

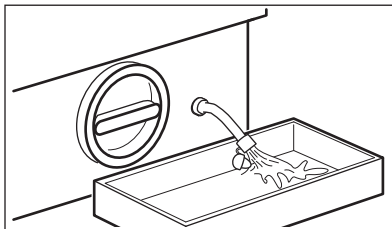

4. Release the emergency emptying hose, place it in the container and remove its cap cover.

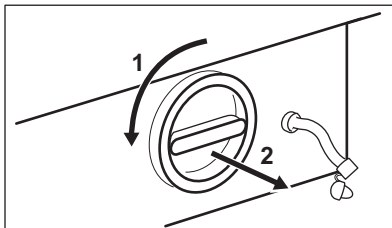

5. When no more water comes out, unscrew the filter cover by turning it anti-clockwise and remove the filter. Use pliers, if necessary. Always keep a rag nearby to dry up any water spillages when removing the cover. Clean the filter under a tap, to remove any traces of fluff.

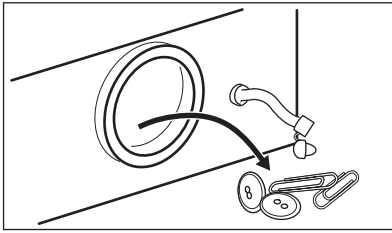

6. Remove foreign bodies and fluff from the filter seat and from the filter impeller.

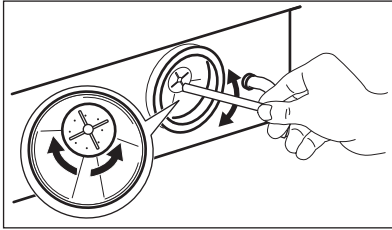

7. Check carefully whether the pump impeller rotates (it rotates jerkily). If it doesn't rotate, please contact your Service Centre.

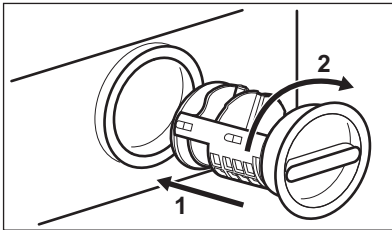

8. Put the cap back on the emergency emptying hose and place the latter back in its seat. Replace the filter into the pump by inserting it correctly into the special guides. Screw the filter cover firmly by turning it clockwise.

14.7 Cleaning the inlet hose and the valve filter

1.

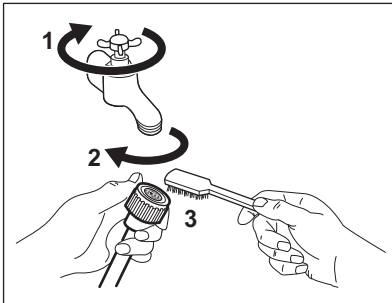

2.

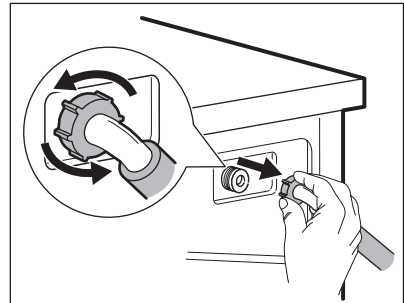

3.

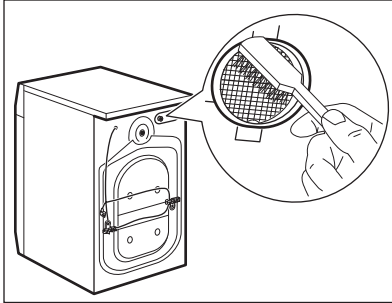

14.8 Frost precautions

If the appliance is installed in an area where the temperature can be less than 0° C, remove the remaining water from the inlet hose and the drain pump.

1. Disconnect the mains plug from the mains socket.
2. Close the water tap.
3. Place the end of the emergency emptying hose and that of the inlet hose in a bowl placed on the floor and let water flow out of the hoses.
4. Set the Drain programme and let it operate until the end of the cycle.
5. Turn the programme knob to On/Off to disconnect the appliance from the power supply.
6. Screw the water inlet hose back on and re-fit the emergency emptying hose after having put the cap on again.



WARNING!

Make sure that the temperature is more than 0 °C before you use the appliance again.
The manufacturer is not responsible for damages caused by low temperatures.

4.

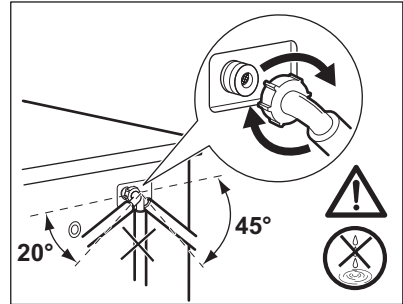

14.9 Emergency emptying out

If the appliance does not drain the water, proceed as follows:

1. Disconnect the mains plug from the mains socket.
2. Close the water tap.
3. If necessary, wait until the water has cooled down.
4. Place a bowl on the floor and put the end of the emergency emptying hose into the bowl. Remove its cap.

The water should drain by gravity into the bowl.

5. When the bowl is full, put the cap back on the emergency hose.
6. Empty the bowl. Repeat the procedure until water stops flowing out.
7. Clean the pump if necessary as previously described.
8. Replace the emergency emptying hose in its seat after having plugged it.
9. Screw the water inlet hose back on.

15. TROUBLESHOOTING



WARNING!

Refer to Safety chapters.

15.1 Introduction

The appliance does not start or it stops during operation.

First try to find a solution to the problem (refer to the table). If the problem persists, contact the Authorised Service Centre.

With some problems, the acoustic signals operate and the display shows an alarm code:

- **E10** - The appliance does not fill with water properly.
- **E20** - The appliance does not drain the water.
- **E40** - The appliance door is open or not closed correctly. Please check the door!

- **E40** - The mains supply is unstable. Wait until the mains supply is stable.
- **E91** - No communication between electronic elements of the appliance. Switch off and switch on again.



WARNING!

Deactivate the appliance before you do the checks.

15.2 Possible failures

Problem	Possible cause/solution
The programme does not start.	Make sure that the mains plug is connected to the mains socket.
	Make sure that the appliance door is closed.
	Make sure that there is not a damaged fuse in the fuse box.
	Make sure that the Start/Pause has been pressed.
	If the delay start is set, cancel the setting or wait for the end of countdown.
	Deactivate the Child Lock function if it is on (if available).
The appliance does not fill with water properly.	Make sure that the water tap is open.
	Make sure that the pressure of the water supply is not too low. For this information, contact your local water authority.
	Make sure that the water tap is not clogged.
	Make sure that the filter of the inlet hose and the filter of the valve are not clogged. Refer to "Care and cleaning".
	Make sure that the inlet hose has no kinks or bends.
	Make sure that the connection of the water inlet hose is correct.
	Make sure that the drain hose is in the correct position. The hose may be too low.

Problem	Possible cause/solution
The appliance does not drain the water.	Make sure that the sink spigot is not clogged.
	Make sure that the drain hose has no kinks or bends.
	Make sure that the drain filter is not clogged. Clean the filter, if necessary. Refer to 'Care and cleaning'.
	Make sure that the connection of the drain hose is correct.
	Set the drain programme if you set a programme without drain phase.
	Set the drain programme if you set an option which ends with water in the tub.
The spin phase does not operate or the washing cycle lasts longer than usually.	Set the spin programme.
	Make sure that the drain filter is not clogged. Clean the filter, if necessary. Refer to 'Care and cleaning'.
There is water on the floor.	Adjust manually the items in the tub and start the spin phase again. This problem may be caused by balance problems.
	Make sure that the couplings of the water hoses are tight and there is not water leakages.
	Make sure that the drain hose have no damages.
	Make sure you use the correct detergent and the correct quantity of it.
	Make sure you have replaced the emergency emptying cap into the filter
	Make sure you have properly screwed the filter in after cleaning.
You cannot open the appliance door.	Make sure that the washing programme is finished.
	Set the drain or the spin programme if there is water in the drum.
The appliance makes an unusual noise.	Make sure the levelling of the appliance is correct. Refer to 'Installation'.
	Make sure that the packaging and/or the transit bolts are removed. Refer to 'Installation'.
	Add more laundry in the drum. The load may be too small.

Problem	Possible cause/solution
The washing results are not satisfactory.	Increase the detergent quantity or use a different detergent.
	Use special products to remove the stubborn stains before you wash the laundry.
	Make sure that you set the correct temperature.
	Decrease the laundry load.
The machine does not dry or does not dry properly:	Make sure that you have set a suitable drying programme for your laundry.
	Make sure that you set the correct the drying time or dryness degree.
	Make sure that the water tap is not turned on.
	Make sure the drain filter is not clogged.
	Make sure you have not overloaded the appliance.
The laundry is full of different coloured fluff:	The fabrics washed in the previous cycle released fluff of a different colour.
	Clean the clothes with a fluff remover
	The drying phase helps to eliminate some fluff.
In case of an excessive amount of fluff in the drum, refer to section «FLUFF IN THE FABRICS».	<ul style="list-style-type: none"> • Thoroughly clean the empty drum, the gasket and the door with a wet rag. • Perform a rinse cycle. • Put a wool or piled fabric rag inside the drum. • Perform a drying cycle of 10 minutes. • Remove the old wool cloth. <p>Now you can wash other garments.</p>

After the check, activate the appliance.
The programme continues from the point of interruption.

If the problem occurs again, contact the
Authorised Service Centre.

If the display shows other alarm codes.
Deactivate and activate the appliance. If
the problem continues, contact the
Service.

16. INSTALLATION

16.1 Unpacking



WARNING!

Remove all the packaging and the transit bolts before installing the appliance.

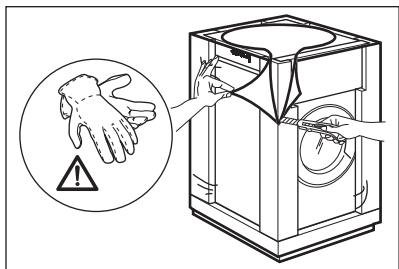

Use the gloves. Remove the external film. If necessary, use a cutter.

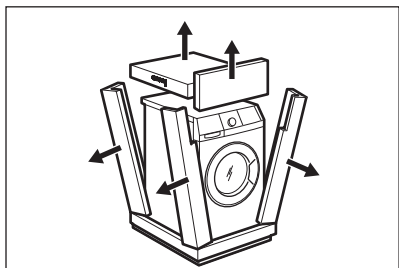

Remove the cardboard top. Remove the polystyrene packaging materials.

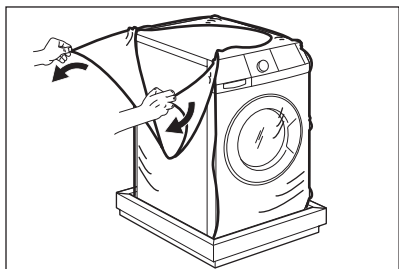

Remove the internal film.

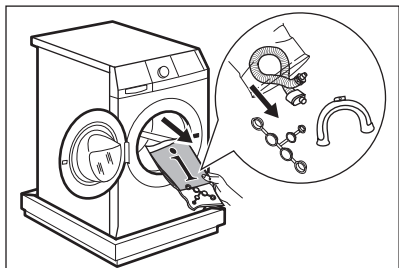

Open the door. Remove the polystyrene piece from the door seal and all the items from the drum.

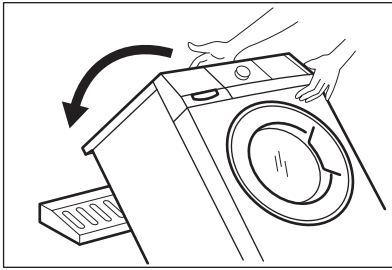

Put one of the polystyrene packaging elements on the floor behind the appliance. Carefully put down the appliance with the rear side on it. Make sure not to damage the hoses.

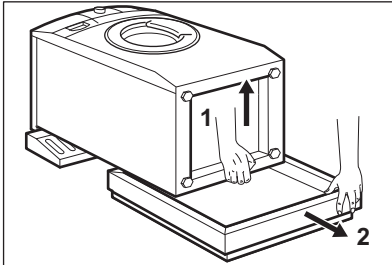

Remove the polystyrene protection from the bottom. Pull up the appliance in vertical position.

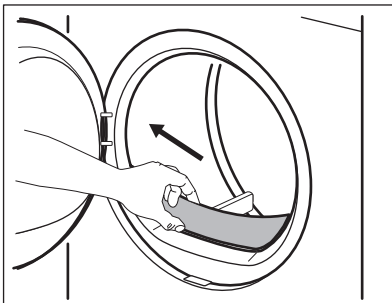

Remove the polystyrene block fitted on the door seal (if present). Pull out all items from the drum.

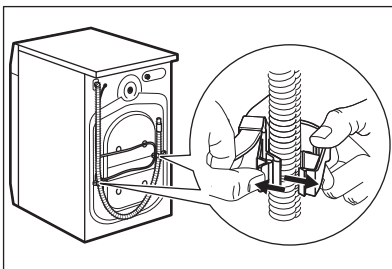

Remove the power supply cable and the drain hose from the hose holders.

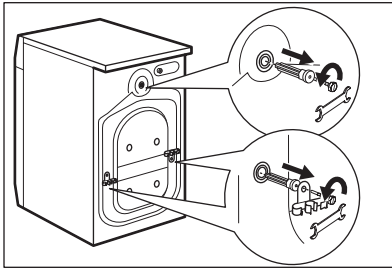

Remove the three bolts. Use the key supplied with the appliance. Pull out the plastic spacers.

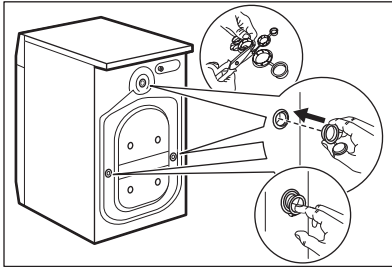

Put the plastic caps in the holes. You can find these caps in the user manual bag.

i We recommend that you keep the packaging and the transit bolts for any movements of the appliance.

16.2 Positioning and levelling

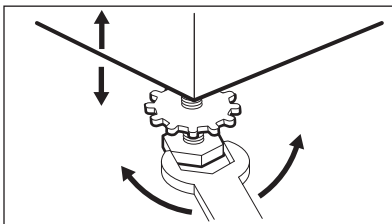

- Install the appliance on a flat hard floor.
- Make sure that air circulation around the appliance is not impeded by carpets, rugs etc.
- Level the appliance by raising or lowering the feet.

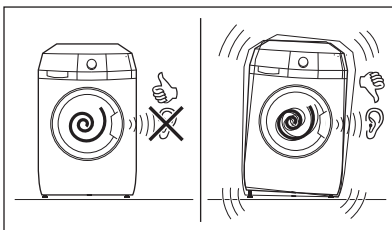

- The feet may be tight to adjust as they incorporate a self locking nut, but the appliance **MUST** be level and stable. If necessary, check the setting with a spirit level. Any necessary adjustment can be made with a spanner. Accurate levelling prevents vibration, noise and displacement of the appliance during operation.

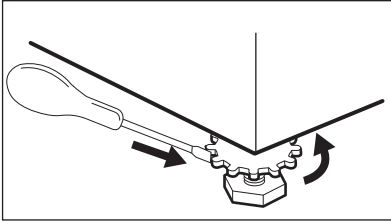

- After having levelled the appliance, tighten the lock nuts.

**WARNING!**

Never place cardboard, wood or similar materials under the appliance to compensate for any unevenness in the floor.

16.3 The inlet hose

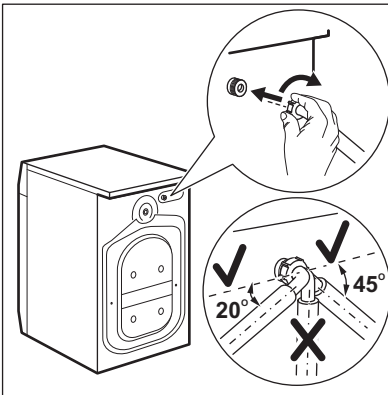

- Connect the hose to the back appliance. Turn the inlet hose only left or right.
- Loose the ring nut to set it in the correct position.

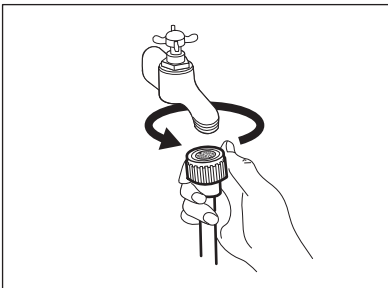

- Connect the water inlet hose to the cold water tap with 3/4 thread.

**CAUTION!**

Make sure that there are no leaks from the couplings.



Do not use an extension hose if the inlet hose is too short. Contact the service centre for the replacement of the inlet hose.

16.4 Water drainage

There are different procedures to connect the drain hose:

With the plastic hose guide.

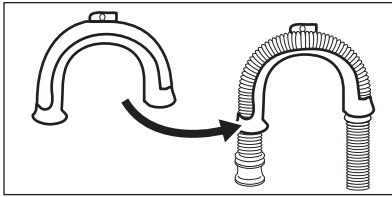

- Make a U shape with the drain hose.

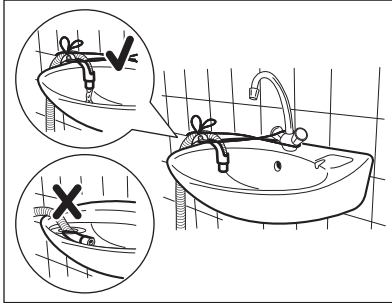

On the edge of a sink

- Make sure that the plastic guide cannot move when the appliance drains. Attach the guide to the water tap or the wall.

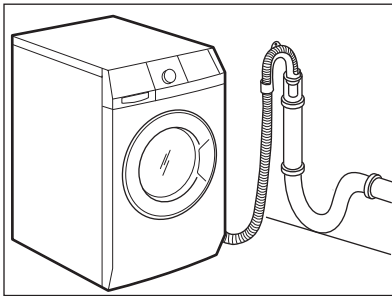

To a stand pipe with vent-hole

- Directly into a drain pipe at a height of not less than 60 cm (23.6") and not more than 100 cm (39.3"). Refer to the illustration.
- The end of the drain hose must always be ventilated, i.e. the inner diameter of the drain pipe (min. 38 mm - min. 1.5") must be larger than the external diameter of the drain hose.

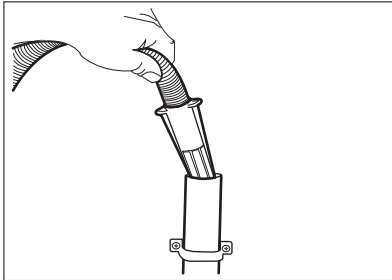

Drain hose end

- If the end of the drain hose looks like this (see the picture), you can push it directly into the stand pipe.

Without the plastic hose guide.

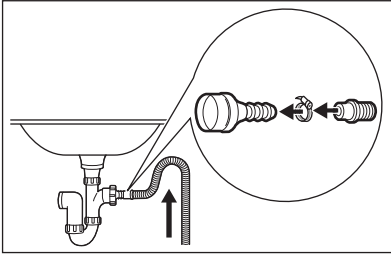

To a sink spigot

- Refer to the illustration. Put the drain hose in the spigot and tighten it with a clip.
- Make sure that the drain hose makes a loop to prevent particles going into the appliance from the sink.

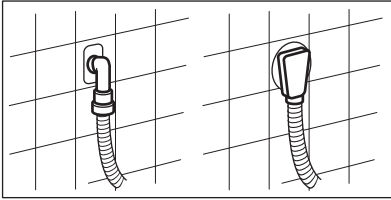

To a wall-pipe

- Directly to a built-in drain pipe in the room wall and tighten it with a clip.



You can extend the drain hose to maximum 400 cm. Contact the service centre for the other drain hose and the extension.

16.5 Building in

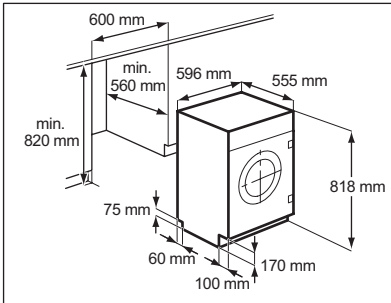

This appliance has been designed to be built into the kitchen furniture. The recess should have the dimensions shown in this picture.

16.6 Preparation and assembly of the door

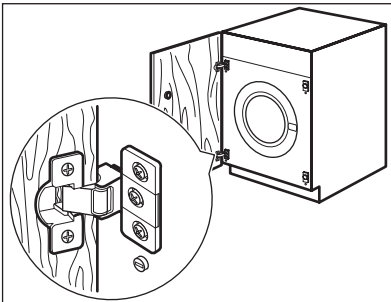

The appliance is originally pre set for the assembly of a door opening from right to left.

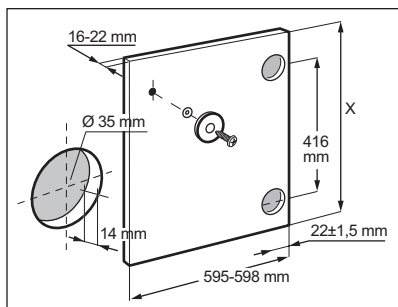

Door

The dimensions of the door should be:

- width 595 - 598 mm
- thickness 16-22 mm
- the height X depends on the height of the adjacent furniture's base.

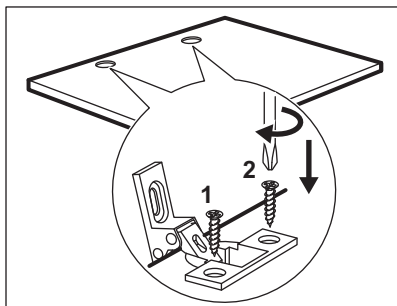

Hinges

To mount the hinges it is necessary to drill two holes (dia. 35 mm, depth 12.5-14 mm depending on the depth of door furniture) on the inner side of the door.

The distance between the hole fixing centres must be 416 mm. The distance from upper edge of the door to the centre of the hole depends on the adjacent furniture's dimensions.

The hinges will be fixed to the door by means of screws for wood **1** and **2** supplied with the appliance.

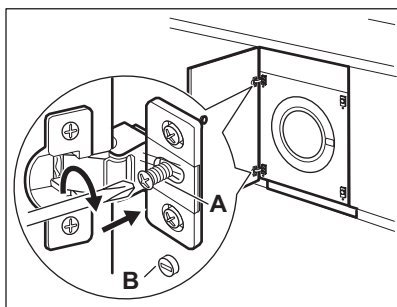

Mounting the door



WARNING!

Do not remove the screw **B**.

Fix the hinges to the appliance by means of the M5x15 screws.

The hinges can be adjusted to compensate for possible uneven thickness of the door.

To align the door perfectly it is necessary to loosen the screw, adjust the door and tighten the screw **A** again.

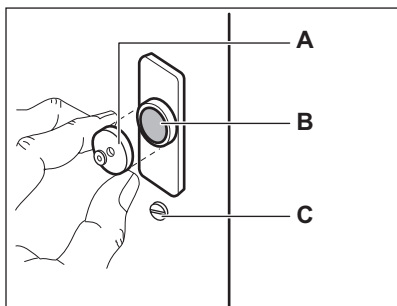

Counter-magnet



WARNING!

Do not remove the screw **B**.

The appliance is pre set for a magnetic door closure. To position the closure correctly, it is necessary to screw the counter-magnet **A** (steel disk + rubber ring) into the inner side of the door.

Its position must correspond to the magnet **B** on the appliance.

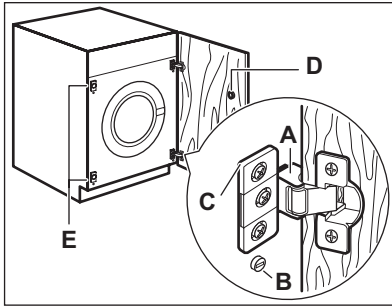
**WARNING!**

Do not remove the screw **B**.

If the door has to be opened from left to right, invert the position of the plates **E**, the magnet **D** and the plate **C**. Mount the counter-magnet **D** and the hinges **A** as previously described.

17. TECHNICAL DATA

Dimension	Width/ Height/ Depth/ Total depth	596 mm/ 820 mm/ 544 mm/ 560 mm
Electrical connection	Voltage Overall power Fuse Frequency	220-240 V 2050 W 13 A 50 Hz
Level of protection against ingress of solid particles and moisture ensured by the protective cover, except where the low voltage equipment has no protection against moisture		IPX4
Water supply pressure	Minimum Maximum	0,5 bar (0,05 MPa) 8 bar (0,8 MPa)
Maximum wash load	Cotton	7 kg
Maximum dry load	Cotton Synthetics	4 kg 2 kg
Spin Speed	Maximum	1400 rpm

18. ENVIRONMENTAL CONCERNS

Recycle the materials with the symbol . Put the packaging in applicable containers to recycle it. Help protect the environment and human health and to recycle waste of electrical and electronic appliances. Do not dispose appliances

marked with the symbol  with the household waste. Return the product to your local recycling facility or contact your municipal office.

www.electrolux.com/shop



132938501-A-282016

