

EN

User manual

Exhaust Dryer

USER MANUAL

ZDE47200W

ZANUSSI

Contents

Important safety information	2	Cleaning and maintenance	8
Product description	4	What to do if	9
Control panel	4	Machine settings	10
Before first use	5	Technical data	10
Sorting and preparing laundry	5	Installation	11
Programme chart	6	Environment	13
Daily use	7	Service	13

Subject to change without notice.

Important safety information

Important! In the interest of your safety and to ensure the correct use, before installing and first using the appliance, read this user manual carefully, including its hints and warnings. To avoid unnecessary mistakes and accidents, it is important to ensure that all people using the appliance are thoroughly familiar with its operation and safety features. Save these instructions and make sure that they remain with the appliance if it is moved or sold, so that everyone using it through its life will be properly informed on appliance use and safety.



- Please read the instruction book before using this appliance.

General safety

- It is dangerous to alter the specifications or attempt to modify this product in any way.
- This appliance is not intended for use by persons (including children) with reduced physical and sensory conditions or lack of experience and knowledge, unless they have been given supervision or instruction concerning use of the appliance by a person responsible for their safety.
- Make sure that small children and pets do not climb inside the drum. To avoid this, please check into the drum before using.
- Any objects such as coins, safety pins, nails, screws, stones or any other hard, sharp material can cause extensive damage and must not be placed into the machine.
- In order to avoid danger of fires caused by excessive drying, do not use appliance to dry the following items: Cushions, quilts etc. (these items accumulate heat).
- Items such as foam rubber (latex foam), shower caps, waterproof textiles, rubber backed articles and clothes

or pillows fitted with foam rubber pads should not be dried in the tumble dryer.

- Always unplug the appliance after use, cleaning and maintenance.
- Under no circumstances should you attempt to repair the machine yourself. Repairs carried out by inexperienced persons may cause injury or serious malfunctioning. Contact your local Service Centre. Always insist on genuine spare parts.
- Items that have been soiled with substances such as cooking oil acetone, petrol, kerosene, spot removers, turpentine, waxes and wax removers should be washed in hot water with an extra amount of detergent before being dried in the tumble dryer.
- **Danger of explosion:** Never tumble dry items that have been in contact with inflammable solvents (petrol, methylated spirits, dry cleaning fluid and the like). As these substances are volatile, they could cause an explosion. Only tumble dry items washed with water.
- **Risk of fire:** items that have been spotted or soaked with vegetable or cooking oil constitute a fire hazard and should not be placed in the tumble dryer.
- If you have washed your laundry with stain remover you must execute an extra rinse cycle before loading your tumble dryer.
- Please make sure that no gas lighters or matches have accidentally been left in pockets of garments incase they are loaded into appliance



Warning!

- **Risk of fire! Never stop a tumble dry before the end of the drying cycle unless all items are quickly removed and spread out so that the heat is dissipated.**
- **Lint must not be allowed to accumulate around the tumble dryer.**
- **Risk of electric shock!** Do not spray down the appliance with jets of water.
- The final part of a tumble dryer cycle occurs without heat (cool down cycle) to ensure that the items are left at a temperature that ensures that items will not be damaged.
- The tumble dryer is not to be used if industrial chemicals have been used for cleaning.
- Ensure you have good ventilation in the installation room to avoid the back flow of gases into the room from appliances burning other fuels, including open fires.

Installation

- This appliance is heavy. Care should be taken when moving it.
- When unpacking the appliance, check that it is not damaged. If in doubt, do not use it and contact the Service Centre.
- All packaging must be removed before use. Serious damage can occur to the product and to property if this is not adhered to. See relevant section in the user manual.
- Any electrical work required to install this appliance should be carried out by a qualified electrician or competent person.
- If the machine is situated on a carpeted floor, please adjust the feet in order to allow air to circulate freely under the appliance.
- After having installed the appliance, check that it is not pressing or standing on its electrical supply cable.
- If the tumble dryer is placed on top of a washing machine, it is compulsory to use the stacking kit (optional accessory).
- After having installed the appliance, check that it is not pressing or standing on its inlet hose.

Use

- This appliance is designed for domestic use. It must not be used for purposes other than those for which it was designed.
- Only wash fabrics which are designed to be machine dried. Follow the instructions on each garment label.
- Do not dry unwashed items in the tumble dryer.
- Do not overload the appliance. See the relevant section in the user manual.
- Clothes which are dripping wet should not be placed in the dryer.
- Garments which have been in contact with volatile petroleum products should not be machine dried. If volatile cleaning fluids are used, care should be taken to ensure that the fluid is removed from the garment before placing in the machine.
- Never pull the power supply cable to remove the plug from the socket; always take hold of the plug itself.
- Never use the tumble dryer if the power supply cable, the control panel, the working surface or the base are damaged so that the inside of the tumble dryer is accessible.
- Fabric softeners, or similar products should be used as specified by the fabric softener instructions.
- **Caution - hot surface** : Do not touch the door light cover surface when the light is switched on. (Only dryers equipped with internal drum light)
-  **Hot surface:** Do not touch the back of the appliance while it is operating!

Child safety

- This machine is not intended for use by young children or infirm persons without supervision.
- Children often do not recognise the hazards associated with electrical appliances. Children should be supervised to ensure that they do not play with the appliance.



Warning!

- Danger of suffocation! The packaging components (e.g. plastic film, polystyrene) can be dangerous to children - Keep them out of children's reach.
- Keep all detergents in a safe place out of children's reach.

- Make sure that children or pets do not climb inside the drum.

Product description

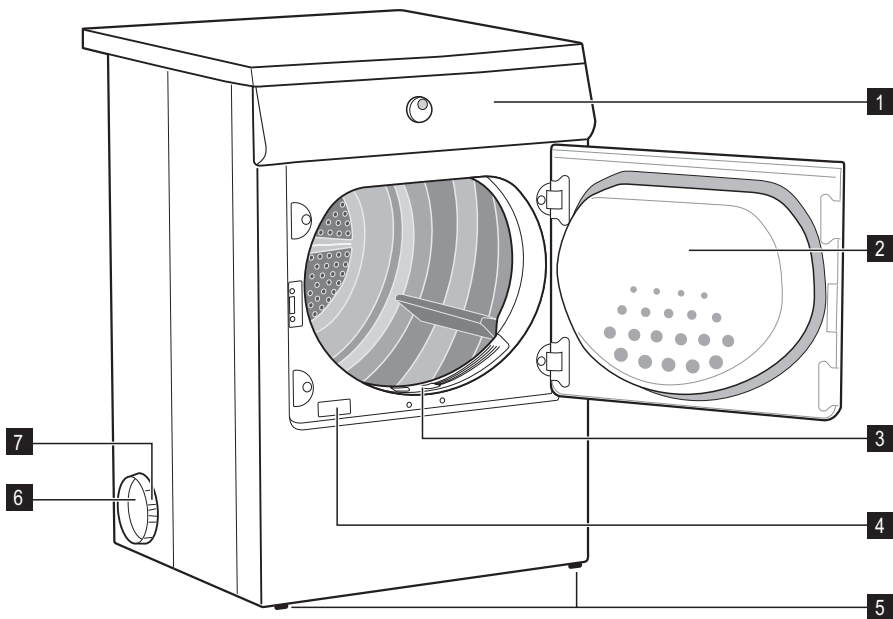

1 Control panel

2 Door

3 Fluff filter

4 Rating plate

5 Adjustable feet

6 Sideways vent outlets / back vent outlet

7 Ring nut

Control panel

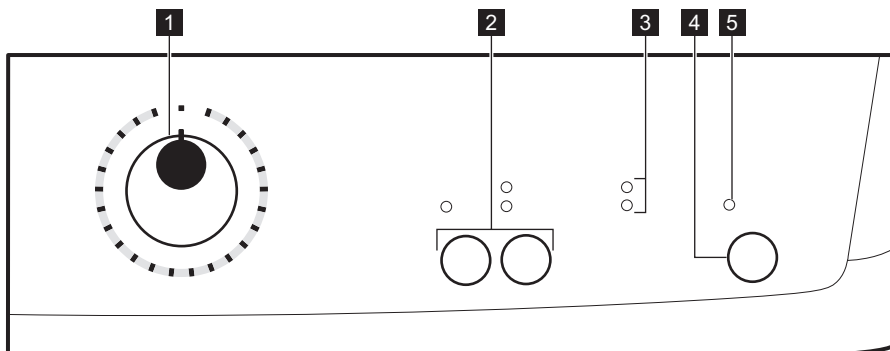

- 1 Programme knob and - OFF switch
- 2 Function buttons (from left to right):
DELICATE , TEXTILE
- 3 Programme phase lights (from up to down:)

- DRYING light
- END/ANTI-CREASE light
- 4 START PAUSE button
- 5 FILTER light

Before first use





In order to remove any residues which may have been produced during production, wipe the dryer drum with a

damp cloth or carry out a brief drying cycle (ca. 30 min.) with damp cloths in the machine.

Sorting and preparing laundry

Sorting laundry

- Sort by fabric type:
 - Cotton/linen for programmes in COTTON programme group.
 - Mixtures and synthetics for programmes in SYNTHETICS programme group.
- Sort by care label: The care labels mean:

	Drying in the tumble dryer possible in principle
	Drying at normal temperature
	Drying at reduced temperature (press DELICATE button!)
	Drying in the tumble dryer not possible

Important! Do not place in the appliance any wet laundry which is not specified on the care label as being suitable for tumble-drying.

This appliance can be used for all wet laundry items which are labelled as suitable for tumble-drying.

- Do not dry new, coloured textiles together with light-coloured laundry items. Textile colours may bleed.
- Do not dry cotton jersey and knitwear with the EXTRA DRY programme. Items may shrink!

Preparing laundry

- To avoid laundry becoming tangled: close zips, button up duvet covers and tie loose ties or ribbons (e.g. of aprons).
- Empty pockets. Remove metal items (paper clips, safety pins, etc).

- Turn items with double-layered fabrics inside out (e.g. with cotton-lined anoraks, the cotton layer should be outermost). These fabrics will then dry better.

Important! Do not overload the appliance. Observe max. loading volume of **6 kg**.

Laundry weights

Type of laundry	Weight
Bathrobe	1200 g
Napkin	100 g
Quilt cover	700 g
Sheet	500 g
Pillow case	200 g
Tablecloth	250 g
Towelling towel	200 g
Tea cloth	100 g
Night dress	200 g
Ladies' briefs	100 g
Man's work shirt	600 g
Man's work shirt	200 g
Man's pyjamas	500 g
Blouse	100 g
Men's underpants	100 g

Programme chart

Programmes	Time in minutes (about)	max. load (weight when dry)	Application/properties	Care mark
 COTTON EXTRA DRY	A ¹⁾	7 kg	Thorough drying of thick or multi-layered fabrics, e.g. terry towelling items, bathrobes.	 
 COTTON STRONG DRY	125	7 kg	Thorough drying of thick or multi-layered fabrics, e.g. terry towelling items, bathrobes.	 
 COTTON STORAGE DRY ²⁾	A ¹⁾	7 kg	Thorough drying of fabrics of even thicknesses, e.g. terry towelling items, knitwear, towels.	 
 COTTON DAMP ²⁾	105	7 kg	For thin textiles which are still to be ironed, e.g. knitted items, cotton shirts.	 
 COTTON IRON DRY ²⁾	95	7 kg	For thin fabrics which are also to be ironed, e.g. knitwear, cotton shirts.	 
 SYNTHETICS EXTRA DRY	A ¹⁾	3 kg	Thorough drying of thick or multi-layered fabrics, e.g. pullovers, bedding, table linen.	  
 SYNTHETICS STORAGE DRY ²⁾	A ¹⁾	3 kg	For thin fabrics which are not ironed, e.g. easy care shirts, table linen, baby clothes, socks, lingerie with bones or wires.	  
 SPECIAL EASY IRON	A ¹⁾	1 kg	Special programme with anti-crease mechanism for easy care textiles such shirts and blouses; for minimum ironing effort. The result depends on the type and quality of textiles. (The loading volume corresponds to approx. 5 to 7 shirts.) Recommendation: Place textiles in the dryer straight after spinning. Once dried, immediately remove textiles and place on clothes hanger.	  
 SPECIAL WOOL CARE	A ¹⁾	1 kg	WOOL CARE is special programme for briefly treating woollens with warm air after they have been dried naturally, worn or stored for long periods. Wool fibres are aligned and the wool becomes soft and snugly.	  
 SPECIAL RE-FRESH	A ¹⁾	1 kg	For refreshing or gently cleaning textiles with commercially available dry cleaning products.	  

Programmes	Time in minutes (about)	max. load (weight when dry)	Application/properties	Care mark
★ SPECIAL COOLING	A ¹⁾	7 kg	Special programme, lasting around 10 minutes, for refreshing or gently cleaning textiles with commercially available dry cleaning sets. (Only use those products which are declared as suitable for the drier by the manufacturer; please observe the manufacturer's instructions for use.)	
JEANS	135	7 kg	For leisure clothing, such as jeans, sweat-shirts, etc., of different material thicknesses (e.g. at the neck, cuffs and seams).	

1) Automatic

2) In accordance with IEC61121

Programme chart in accordance with IEC61121

The appliance should be tested based on time controlled programmes.

Daily use

Switching machine on

Turn the programme selector to any programme. The machine switches on.

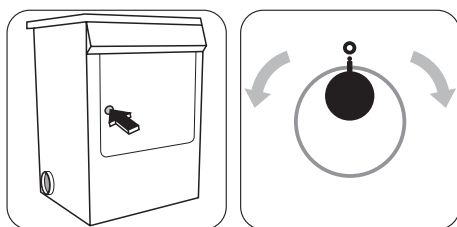

Door opening and laundry loading

1. Open the door.
 2. Load your laundry (do not force it in).
- Caution!** Do not jam laundry in between the loading door and rubber seal.
3. Close loading door securely. Lock must audibly lock.

Selecting the programme

Turn the programme selector dial to the required programme. The light START/PAUSE starts to flash.

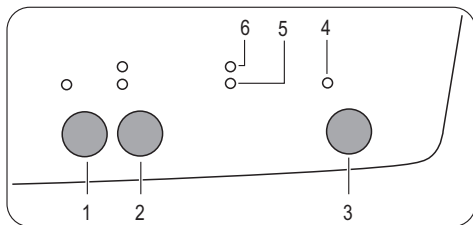

Selecting additional functions

You can choose from the additional functions:

button 1 - DELICATE

button 2 - TEXTILE

DELICATE

gentle drying with reduced heat of sensitive fabrics and temperature-sensitive textiles (e.g. acrylic, viscose) marked on care label with:

TEXTILE

Press the Textile button repeatedly, to select the desired option. The relevant light will light up. You can select 2 different options: COTTON cycle: to be used for cotton, and SYNTHETICS : to be used for synthetic or delicate items.

Starting the programme

Press the START PAUSE button. The programme is started.

The programme phase is shown by appropriate lights; light 6- DRYING , light 5- ANTICREASE-END .

Changing programme

To change a programme which has been selected by mistake once the programme has started, first turn the pro-

Cleaning and maintenance

Warning! The tumble dryer is not to be used if industrial chemicals have been used for cleaning!

Warning! You must DISCONNECT the appliance from the electricity supply, before you can carry out any cleaning or maintenance work.

gramme selector to OFF position. The programme is cancelled.

The programme can no longer be changed directly once the programme has started. If nevertheless there is an attempt to change the programme on the programme knob or if a function button (excluding the **BUZZER** button¹⁾) is pressed, led on the START/PAUSE button starts flashing temporarily in red. The drying programme is not however affected by this (laundry protection).

Drying cycle complete / removing laundry

Once the drying cycle is complete, the lights ANTI-CREASE-END and light 4- FILTER are on. If the buzzer is active, an acoustic signal sounds intermittently for about one minute.

The drying cycles are automatically followed by an anti-crease phase which lasts around 30 minutes. The drum rotates at intervals during this phase. This keeps the laundry loose and free of creases. The laundry can be removed at any time during the anti-crease phase. (The laundry should be taken out towards the end of the anti-crease phase at the latest to prevent creases from forming.)

1. Open door.
2. Clean the filter.
3. Remove laundry.
4. Turn the programme selector to **"0"** - OFF .

Important! Clean the filter after each drying cycle.

5. Close the door.

Cleaning fluff filter

The filter collect all the fluff which accumulates during drying. To ensure that the dryer works perfectly, the fluff filter must be cleaned after every drying cycle. The warning light FILTER , is on to remind you this operation.

Caution! Never operate the dryer without fluff filter or with damaged or blocked fluff filter.

1) Only dryers with buzzer button

1. Open loading door and remove laundry.
2. Remove the filter which is built into the lower part of the loading aperture.

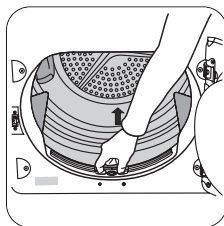

3. Open the filter pressing the button, among two slots on fingers. Clean the filter using dump hand or cloth. After a period of time, a patina due to detergent residue on laundry forms on the filters. When this occurs, clean the filter with warm water using a brush. Close the filter and do not forget to put it back.

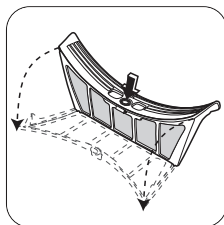

Warning! Before You place the filter, please check it there is nothing inside the filter seat.

4. The filter can be positioned only to one side. If position is wrong, the filter overhangs.

i If the filter will not snap into place, the loading door cannot be closed.

Cleaning the door

Clean periodically the interior part of the door to remove any fluff. Accurate cleaning ensures correct drying.

Cleaning the drum

! **Caution!** Do not use abrasives or steel wool to clean the drum.

i Lime in the water or cleaning agents may form a barely visible lining on the inside of the drum. The degree to which the laundry has been dried is then no longer detected reliably. The laundry is damper than expected when removed from the dryer.

Use a standard domestic cleaner (e.g. vinegar-based cleaner) to wipe down the inside of the drum and drum ribs.

Clean operating screen and housing

! **Caution!** Do not use furniture cleaners or aggressive cleaning agents to clean the machine.

Use a damp cloth to wipe down the operating screen and housing.

What to do if ...

Problem	Possible cause	Remedy
Dryer does not work.	Mains plug is not plugged in or fuse is not working correctly.	Plug in at mains socket. Check fuse in fuse box (domestic installation).
	Loading door is open.	Close loading door.
	Have you pressed the START PAUSE button?	Press the START PAUSE button again.
Drying results unsatisfactory.	Wrong programme selected.	Select a different programme the next time you dry (see "Programme chart" chapter).
	Fluff filter clogged.	Clean fluff filter.
	Overloading of laundry.	Observe recommended loading volumes.
	Ventilation slots covered up.	Uncover ventilation slots.
	Residue on inside surface of drum or drum ribs.	Clean inside surface of drum and drum ribs.

Problem	Possible cause	Remedy
	Conductance of water at installation site differs from standard setting of machine. ¹⁾	Re-programme standard setting for degree of drying (see 'Machine settings' chapter ¹⁾).
	To little free space around the appliance	Ensure min. 5cm free space around the appliance
Loading door does not close.	Filter not in place ²⁾ .	Install filter into place ²⁾ .
Drying cycle ends shortly after programme starts.	Not enough washing loaded or washing loaded is too dry for selected programme.	Select time programme or higher drying level (e.g. EXTRA DRY instead of CUPBOARD DRY).
Drying cycle lasts an unusually long time. Note: After around 5 hours the drying cycle ends automatically.	Filter clogged.	Clean filter.
	Load volume too big.	Reduce load volume.
	Laundry insufficiently spun.	Laundry must be adequately spun.

1) Only dryers with conductance programming

2) Only dryers with removable filter

Machine settings

BUZZER permanent off

1. Turn the programme selector to any programme.
2. Press simultaneously the **DELICATE** and **TEXTILE** buttons and hold down for approx. 5 seconds.
3. The buzzer is by default always off.

Technical data

height x width x depth	85 x 60 x 58 cm
drum volume	108 l
depth with the load door opened	109 cm
adjustable height	1.5 cm
the appliance weight	32 kg
maximum load volume	7 kg
voltage	230-240 V
necessary fuse	13 A
total power	2350 W
energy efficiency class	C
energy consumption kWh/cycle ¹⁾	3,9 kWh
annual energy consumption	263,1 kWh
type of use	Domestic

permitted ambient temperature

+ 5°C to + 35°C

1) 7 kg of cotton, centrifuged at 1000 rpm with reference to EN 61121

Installation

Appliance positioning

- It is recommended that, for your convenience, the appliance is positioned close to your washing machine.
- The tumble dryer must be installed in a clean place, where dirt does not build up.
- Air must be able to circulate freely all round the appliance. Do not obstruct the front ventilation grille or the air intake grilles at the back of the appliance.
- To keep vibration and noise to a minimum when the tumble dryer is in use, it should be placed on a firm, level surface.
- Once in its permanent operating position, check that the tumble dryer is absolutely level with the aid of a spirit level. If it is not, raise or lower the feet until it is.
- The feet must never be removed. Do not restrict the floor clearance through deep pile carpets, strips of wood or similar. This might cause heat built-up which would interfere with the operation of the appliance.

Important!

- The hot air emitted by the tumble dryer can reach temperatures of up to 60°C. The appliance must therefore not be installed on floors which are not resistant to high temperatures.
- When operating the tumble dryer, the room temperature must not be lower than +5°C and higher than +35°C, as it may affect the performance of the appliance.
- Should the appliance be moved, it must be transported vertically.
- The appliance must not be installed behind a lockable door, a sliding door or a door with a hinge on the opposite side to that of the appliance in such a way that a full opening of the tumble dryer is restricted.

Ensure min. 5cm free space around the appliance.

Removing transport safety packaging

-  **Caution!** Before use all parts of the transport packaging must be removed.

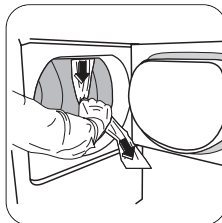

1. Open loading door.
2. Pull off adhesive strips from inside machine on top of drum.

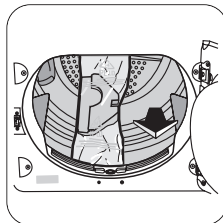

3. Remove foil hose and polystyrene padding from the machine.

Fitting the vent hose

To simplify the installation, there is a choice of vent outlets: one at the back, the others in the left and right-hand side. Connect the hose to whichever is the more convenient by pulling the ring nut (A) from the vent outlet at the back, screwing it on to the hose and pushing it firmly back into place. The unused vents should now be sealed with the special snap covers provided.

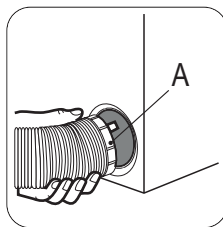
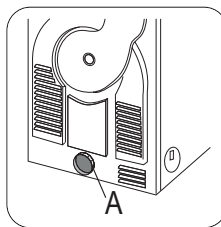

If the hose is long and the room temperature low, the moisture might condense to water inside the hose. This is an unavoidable natural phenomenon. To prevent this water from lying in the hose or flowing back into the tumble dryer, it is advisable to drill a small hole (via. 3 mm) in the lowest

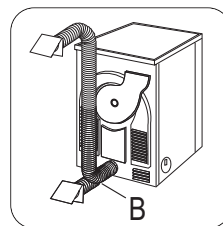

point of the hose and to place a small container below it. (See picture, point B).

Once connected to the dryer, run the vent hose to the desired outlet point, ensuring that the run's overall length is less than 2 m, and that it contains no more than two bends. As to the outlet itself, if you have decided on a fixed wall/window grille, a good local builder's merchant should be able to supply you with the necessary fittings and installation advice.

Warning!

It is important not to connect the vent hose to, for example, a cooker hood, or a chimney or flue pipe designed to carry the exhaust from a fuel burning appliance.

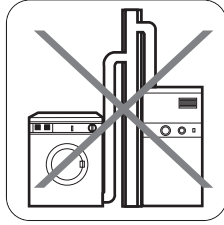

Note that to avoid condensation problems, it is essential that the dryer be fitted with the flexible hose to carry its "exhaust" at least beyond the kitchen units; preferable outside the kitchen. In order to prevent the appliance from overheating, it is important that the steam exhaust is unobstructed. Therefore, in case of a permanent hose fitted to an exterior wall or ceiling, it must be ensured an exhaust capacity of at least 150 m³/h. If the dryer is fitted next to kitchen units, make sure that the vent hose is not squashed. If the hose is partially squashed, drying efficiency will be reduced, resulting in longer drying times and higher energy consumption. If the hose is completely squashed, the safety cut-outs with which the machine is fitted may operate. When operating the tumble dryer, the room temperature must not be lower than +5°C and higher than +35°C, as it may affect the performance of the appliance.

Electrical connection

Details on mains voltage, type of current and the fuses required should be taken from the rating plate. The rating plate is fitted near the loading aperture (see "Product description" chapter).

Connect the machine to an earthed socket, in accordance with current wiring regulations.



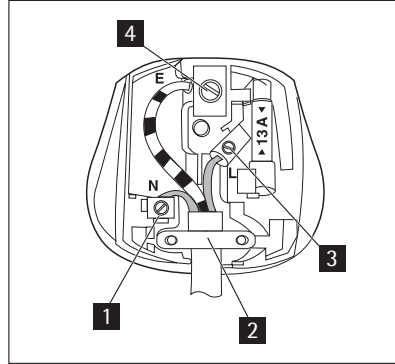

 **Warning! The manufacturer declines any responsibility for damage or injury through failure to comply with the above safety precautions.**

Should the appliance power supply cable need to be replaced, this must be carried out by an authorised service engineer or a qualified electrician.

The appliance is supplied with a 13 amp plug fitted. In the event of having to change the fuse in the plug supplied, a 13 amp ASTA approved BS 1363/A fuse must be used.



The wires in the mains lead are coloured in accordance with the following code:

-  Blue - Neutral
-  cord clamp
-  Brown - Live
-  Green and Yellow - Earth

The wire coloured green and yellow must be connected to the terminal marked with the letter «E» or by the earth symbol \perp or coloured green and yellow.

The wire coloured blue must be connected to the terminal «N» or coloured black.

The wire coloured brown must be connected to the terminal marked «L» or coloured red.

Upon completion there must be no cut, or stray strands of wire present and the cord clamp must be secure over the outer sheath.

 **Warning! A cut off plug inserted into a 13 amp socket is a serious safety (shock) hazard.**

Ensure that the cut off plug is disposed of safely.

 **Warning! The plug must be accessible after installing the machine.**

Permanent connection

In the case of permanent connection it is necessary that you install a double pole switch between the appliance and the electricity supply (mains), with a minimum gap of

3 mm between the switch contacts and of a type suitable for the required load in compliance with the current electrical regulations.

The switch must not break the yellow and green earth cable at any point.

Door reversal

To make it easier to load or unload the laundry, the door can be reversed. The door must only be reversed by an authorised service engineer. Please contact your local Service Force Centre. The engineer will carry out the door reversal at your cost.

Environment

The symbol  on the product or on its packaging indicates that this product may not be treated as household waste. Instead it should be taken to the appropriate collection point for the recycling of electrical and electronic equipment. By ensuring this product is disposed of correctly, you will help prevent potential negative consequences for the environment and human health, which could otherwise be caused by inappropriate waste handling of this product. For more detailed information about recycling of this product, please contact your local council, your household waste disposal service or the shop where you purchased the product.

Packaging material

The packaging materials are environmentally friendly and can be recycled. The plastic components are identified by markings, e.g. >PE<, >PS<, etc. Please dispose of the packaging materials in the appropriate container at the community waste disposal facilities.

 **Warning!** When disposing of old appliances, remove the mains cable and dispose of together

Service

In the event of technical faults, please first check whether you can remedy the problem yourself with the help of the operating instructions (Chapter "What to do if...").

If you were not able to remedy the problem yourself, please contact your local service centre.

In order to be able to assist you quickly, we require the following information:

- Model description
- Product number (PNC)
- Serial number (S No.) (for numbers, see rating plate)

www.zanussi.com

Special accessories

Stacking kit

A special stacking kit is available through your dealer, to enable the mounting of the dryer on top of a front loading washing machine with cover's depth between 48 and 60 cm. Read carefully the instructions supplied with the kit.

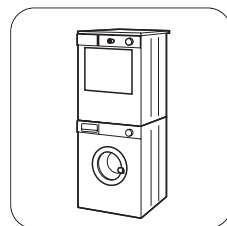

with the plug. Remove the door hook and ensure it is no longer lockable to prevent young children being trapped inside.

Environmental tips

- In the dryer, laundry becomes fluffy and soft. Fabric softeners are not therefore needed when washing.
- Your dryer will function most economically if you:
 - always keep the ventilation slots on the base of the dryer unobstructed;
 - use the loading volumes specified in the programme overview;
 - clean the filter after each drying cycle;
 - spin the laundry well before drying. Example: Consumption data – depending on spinning speed – for 6 kg of laundry, dried using the COTTON CUPBOARD DRY programme.

- Type of fault
 - Any error messages displayed by the appliance
- So that you have the necessary reference numbers from your appliance at hand,

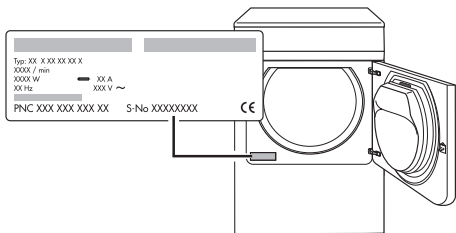

we recommend that you write them in here:

Model description:
PNC:
S No.:



www.zanussi.com/shop

