

EN

User manual

Refrigerator

USER MANUAL

ZBB28651SA

ZANUSSI

Contents

Safety instructions _____	2	Care and cleaning _____	6
Control panel _____	4	What to do if... _____	7
First use _____	5	Installation _____	8
Daily use _____	5	Noises _____	12
Helpful hints and tips _____	5	Technical data _____	13

Subject to change without notice.

Safety instructions

In the interest of your safety and to ensure the correct use, before installing and first using the appliance, read this user manual carefully, including its hints and warnings. To avoid unnecessary mistakes and accidents, it is important to ensure that all people using the appliance are thoroughly familiar with its operation and safety features. Save these instructions and make sure that they remain with the appliance if it is moved or sold, so that everyone using it through its life will be properly informed on appliance use and safety.

For the safety of life and property keep the precautions of these user's instructions as the manufacturer is not responsible for damages caused by omission.

Children and vulnerable people safety

- This appliance is not intended for use by persons (including children) with reduced physical, sensory or mental capabilities, or lack of experience and knowledge, unless they have been given supervision or instruction concerning use of the appliance by a person responsible for their safety. Children should be supervised to ensure that they do not play with the appliance.
- Keep all packaging well away from children. There is risk of suffocation.
- If you are discarding the appliance pull the plug out of the socket, cut the connection cable (as close to the appliance as you can) and remove the door to prevent playing children to suffer electric shock or to close themselves into it.
- If this appliance featuring magnetic door seals is to replace an older appliance having a spring lock (latch) on the door or lid, be

sure to make that spring lock unusable before you discard the old appliance. This will prevent it from becoming a death trap for a child.

General safety

Warning!

Keep ventilation openings, in the appliance enclosure or in the built-in structure, clear of obstruction.

- The appliance is intended for keeping food-stuff and/or beverages in a normal household and similar applications such as:
 - staff kitchen areas in shops, offices and other working environments;
 - farm houses and by clients in hotels, motels and other residential type environments;
 - bed and breakfast type environments;
 - catering and similar non-retail applications.
- Do not use a mechanical device or any artificial means to speed up the thawing process.
- Do not use other electrical appliances (such as ice cream makers) inside of refrigerating appliances, unless they are approved for this purpose by the manufacturer.
- Do not damage the refrigerant circuit.
- The refrigerant isobutane (R600a) is contained within the refrigerant circuit of the appliance, a natural gas with a high level of environmental compatibility, which is nevertheless flammable.

During transportation and installation of the appliance, be certain that none of the components of the refrigerant circuit become damaged.

If the refrigerant circuit should become damaged:

- avoid open flames and sources of ignition
 - thoroughly ventilate the room in which the appliance is situated
- It is dangerous to alter the specifications or modify this product in any way. Any damage to the cord may cause a short-circuit, fire and/or electric shock.

 **Warning!** Any electrical component (power cord, plug, compressor) must be replaced by a certified service agent or qualified service personnel to avoid hazard.

1. Power cord must not be lengthened.
 2. Make sure that the power plug is not squashed or damaged by the back of the appliance. A squashed or damaged power plug may overheat and cause a fire.
 3. Make sure that you can come to the mains plug of the appliance.
 4. Do not pull the mains cable.
 5. If the power plug socket is loose, do not insert the power plug. There is a risk of electric shock or fire.
 6. You must not operate the appliance without the lamp cover (if foreseen) of interior lighting.
- This appliance is heavy. Care should be taken when moving it.
 - Do not remove nor touch items from the freezer compartment if your hands are damp/wet, as this could cause skin abrasions or frost/freezer burns.
 - Avoid prolonged exposure of the appliance to direct sunlight.
 - Bulb lamps (if foreseen) used in this appliance are special purpose lamps selected for household appliances use only. They are not suitable for household room illumination.

Daily use

- Do not put hot pot on the plastic parts in the appliance.
- Do not store flammable gas and liquid in the appliance, because they may explode.
- Appliance's manufacturers storage recommendations should be strictly adhered to. Refer to relevant instructions.

Care and cleaning

- Before maintenance, switch off the appliance and disconnect the mains plug from the mains socket.
- Do not clean the appliance with metal objects.
- Regularly examine the drain in the refrigerator for defrosted water. If necessary, clean the drain. If the drain is blocked, water will collect in the bottom of the appliance.

Installation

Important! For electrical connection carefully follow the instructions given in specific paragraphs.

- Unpack the appliance and check if there are damages on it. Do not connect the appliance if it is damaged. Report possible damages immediately to the place you bought it. In that case retain packing.
- It is advisable to wait at least four hours before connecting the appliance to allow the oil to flow back in the compressor.
- Adequate air circulation should be around the appliance, lacking this leads to overheating. To achieve sufficient ventilation follow the instructions relevant to installation.
- Wherever possible the back of the product should be against a wall to avoid touching or catching warm parts (compressor, condenser) to prevent possible burn.
- The appliance must not be located close to radiators or cookers.
- Make sure that the mains plug is accessible after the installation of the appliance.
- Connect to potable water supply only (If a water connection is foreseen).

Service

- Any electrical work required to do the servicing of the appliance should be carried out by a qualified electrician or competent person.
- This product must be serviced by an authorized Service Centre, and only genuine spare parts must be used.

Environment Protection

-  This appliance does not contain gasses which could damage the ozone layer, in

Control panel

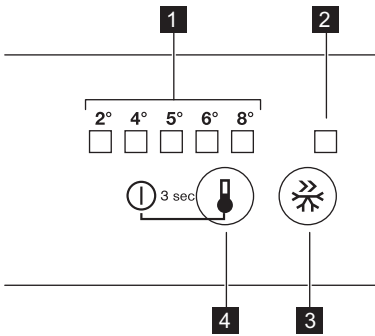

- 1** Temperature indicator LED
- 2** Quick Freeze indicator
- 3** Quick Freeze button
- 4** Temperature regulator ON/OFF button

Switching on

Insert the plug into the wall socket.
Touch the temperature regulator button if all LED are off.

Switching off

Keep touching the temperature regulator button for 3 Sec.
All indicators light off.

Temperature regulation

To operate the appliance, proceed as follows:

- touch the temperature regulator button until the LED corresponding to the required tem-

perature lights up. Selection is progressive, varying from 2 to 8°C.
The appliance shall not be discarded together with the urban refuse and rubbish. The insulation foam contains flammable gases: the appliance shall be disposed according to the applicable regulations to obtain from your local authorities. Avoid damaging the cooling unit, especially at the rear near the heat exchanger. The materials used on this appliance marked by the symbol  are recyclable.

perature lights up. Selection is progressive, varying from 2 to 8°C.

At first button touch actual setting LED keeps blinking.

Any time the button is touch the set temperature is moved to 1 position right. Corresponding LED will blink for a while.

Touch the setting button until the required temperature is selected. The set will be fixed

-  coldest setting: +2°C
warmest setting: +8°C

A medium setting is generally the most suitable.

However, the exact setting should be chosen keeping in mind that the temperature inside the appliance depends on:

- room temperature
- how often the door is opened
- quantity of food stored
- appliance location.

Quick Freeze function

You can activate the Quick Freeze function by pressing the Quick Freeze button.

The LED corresponding to the symbol Quick Freeze indicator lights up.

You can deactivate the Quick Freeze function by pressing the Quick Freeze button again.

The Quick Freeze indicator will light off.

Important!

This function stops automatically after 52 hours.

First use

Cleaning the interior

Before using the appliance for the first time, wash the interior and all internal accessories with lukewarm water and some neutral soap

so as to remove the typical smell of a brand-new product, then dry thoroughly.

Important! Do not use detergents or abrasive powders, as these will damage the finish.

Daily use

Movable shelves

The walls of the refrigerator are equipped with a series of runners so that the shelves can be positioned as desired.

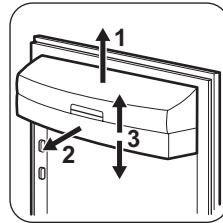
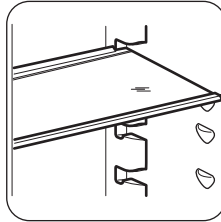

Positioning the door shelves

To store various size food packages, the door shelves can be placed at different heights. Gradually pull the shelf in the direction of the arrows until it comes free, then reposition as required.

Cold accumulators

The freezer contains at least one cold accumulator which increases storage time in the event of a power cut or breakdown.

Helpful hints and tips

Hints for energy saving

- Do not open the door frequently or leave it open longer than absolutely necessary.
- If the ambient temperature is high and the Temperature Regulator is set to low temperature and the appliance is fully loaded, the compressor may run continuously, causing frost or ice on the evaporator. If this happens, set the Temperature Regulator toward warmer settings to allow automatic defrosting and so a saving in electricity consumption.

Hints for fresh food refrigeration

To obtain the best performance:

- do not store warm food or evaporating liquids in the refrigerator
- do cover or wrap the food, particularly if it has a strong flavour

- position food so that air can circulate freely around it

Hints for refrigeration

Useful hints:

Meat (all types) : wrap in polythene bags and place on the glass shelf above the vegetable drawer.

For safety, store in this way only one or two days at the most.

Cooked foods, cold dishes, etc.: these should be covered and may be placed on any shelf.

Fruits and vegetables: these should be thoroughly cleaned and placed in the special drawer(s) provided. When in contact, lemon juice can discolor the plastic parts of your fridge. It is therefore recommended to keep citrus in separate containers.

Butter and cheese: these should be placed in special airtight containers or wrapped in alumi-

mium foil or polythene bags to exclude as much air as possible.

Bottles: these should have a cap and should be stored in the bottle rack on the door.

Care and cleaning

⚠ Caution! Unplug the appliance before carrying out any maintenance operation.

🌿 This appliance contains hydrocarbons in its cooling unit; maintenance and re-charging must therefore only be carried out by authorized technicians.

Periodic cleaning

The equipment has to be cleaned regularly:

- clean the inside and accessories with luke-warm water and some neutral soap.
- regularly check the door seals and wipe clean to ensure they are clean and free from debris.
- rinse and dry thoroughly.

Important! Do not pull, move or damage any pipes and/or cables inside the cabinet.

Never use detergents, abrasive powders, highly perfumed cleaning products or wax polishes to clean the interior as this will damage the surface and leave a strong odour.

Clean the condenser (black grill) and the compressor at the back of the appliance with a brush. This operation will improve the performance of the appliance and save electricity consumption.

Important! Take care of not to damage the cooling system.

Many proprietary kitchen surface cleaners contain chemicals that can attack/damage the plastics used in this appliance. For this reason it is recommended that the outer casing of this appliance is only cleaned with warm water with a little washing-up liquid added. After cleaning, reconnect the equipment to the mains supply.

Defrosting of the refrigerator

Frost is automatically eliminated from the evaporator of the refrigerator compartment ev-

Bananas, potatoes, onions and garlic, if not packed, must not be kept in the refrigerator.

ery time the motor compressor stops, during normal use. The defrost water drains out through a trough into a special container at the back of the appliance, over the motor compressor, where it evaporates.

It is important to periodically clean the defrost water drain hole in the middle of the refrigerator compartment channel to prevent the water overflowing and dripping onto the food inside. Use the special cleaner provided, which you will find already inserted into the drain hole.

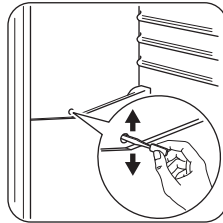

Defrosting of the freezer

The freezer compartment of this model, on the other hand, is a "no frost" type. This means that there is no buildup of frost when it is in operation, neither on the internal walls nor on the foods.

The absence of frost is due to the continuous circulation of cold air inside the compartment, driven by an automatically controlled fan.

Periods of non-operation

When the appliance is not in use for long periods, take the following precautions:

- **disconnect the appliance from electricity supply**
- remove all food
- defrost (if foreseen) and clean the appliance and all accessories
- leave the door/doors ajar to prevent unpleasant smells.

If the cabinet will be kept on, ask somebody to check it once in a while to prevent the food inside from spoiling in case of a power failure.

What to do if...

Warning! Before troubleshooting, disconnect the mains plug from the mains socket.

Only a qualified electrician or competent person must do the troubleshooting that is not in this manual.

Important! There are some sounds during normal use (compressor, refrigerant circulation).

Problem	Possible cause	Solution
The appliance does not operate. The lamp does not operate.	The appliance is switched off.	Switch on the appliance.
	The mains plug is not connected to the mains socket correctly.	Connect the mains plug to the mains socket correctly.
The lamp does not work.	The appliance has no power. There is no voltage in the mains socket.	Connect a different electrical appliance to the mains socket. Contact a qualified electrician.
	The lamp is in stand-by.	Close and open the door.
The compressor operates continually.	The lamp is defective.	Refer to "Replacing the lamp".
	The temperature is not set correctly.	Set a higher temperature.
	The door is not closed correctly.	Refer to "Closing the door".
	The door has been opened too frequently.	Do not keep the door open longer than necessary.
Water flows on the rear plate of the refrigerator.	The product temperature is too high.	Let the product temperature decrease to room temperature before storage.
	The room temperature is too high.	Decrease the room temperature.
Water flows into the refrigerator.	During the automatic defrosting process, frost defrosts on the rear plate.	This is correct.
	The water outlet is clogged.	Clean the water outlet.
Water flows on the ground.	Products prevent that water flows into the water collector.	Make sure that products do not touch the rear plate.
	The melting water outlet does not flow in the evaporative tray above the compressor.	Attach the melting water outlet to the evaporative tray.
The temperature in the appliance is too low.	The temperature regulator is not set correctly.	Set a higher temperature.

Problem	Possible cause	Solution
The temperature in the appliance is too high.	The temperature regulator is not set correctly.	Set a lower temperature.

Replacing the lamp

The appliance is equipped with a longlife LED interior light.

Only service is allowed to replace the lighting device. Contact your Service Center.

Closing the door

1. Clean the door gaskets.

Installation

Caution! Read the "Safety Information" carefully for your safety and correct operation of the appliance before installing the appliance.

Positioning

Install this appliance at a location where the ambient temperature corresponds to the climate class indicated on the rating plate of the appliance:

Climate class	Ambient temperature
SN	+10°C to +32°C
N	+16°C to +32°C
ST	+16°C to +38°C
T	+16°C to +43°C

Electrical Connection

Caution! Any electrical work required to install this appliance should be carried out by a qualified electrician or competent person.

Warning! This appliance must be earthed.

The manufacturer declines any liability should these safety measures not be observed.

2. If necessary, adjust the door. Refer to "Installation".
3. If necessary, replace the defective door gaskets. Contact the Service Center.

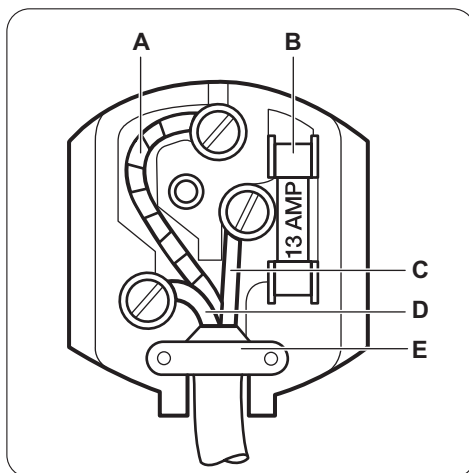

Important! The wires in the mains lead are coloured in accordance with the following code:

- | | | |
|----------|-------------------|---------|
| A | Green and Yellow: | Earth |
| C | Brown: | Live |
| D | Blue: | Neutral |

As the colours of the wires in the mains lead of this appliance may not correspond with the coloured markings identifying the terminals in your plug, proceed as follows:

1. Connect the wire coloured green and yellow to the terminal marked either with the

letter "E" or by the earth symbol \oplus or coloured green and yellow.

2. Connect the wire coloured blue to the terminal either marked with the letter "N" or coloured black.
3. Connect the wire coloured brown to the terminal either marked with the "L" or coloured red.
4. Check that no cut, or stray strands of wire is present and the cord clamp **E** is secure over the outer sheath.
5. Make sure the electricity supply voltage is the same as that indicated on the appliance rating plate.

6. Switch on the appliance.

The appliance is supplied with a 13 amp plug fitted **B**. In the event of having to change the fuse in the plug supplied, a 13 amp ASTA approved (BS 1362) fuse must be used.

Warning! A cut off plug inserted into a 13 amp socket is a serious safety (shock) hazard. Ensure that it is disposed of safely.

Door reversibility

The door of the appliance opens to the right. If you want to open the door to the left, do these steps before you install the appliance:

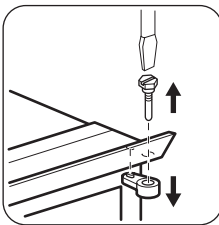

- Loosen the upper pin and remove the spacer.
- Remove the upper pin and the upper door.

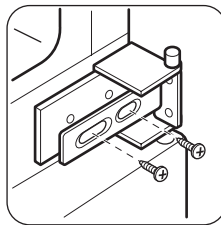

- Loosen the middle hinge.

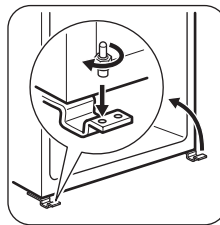

- Remove the lower door.
- Loosen the lower pin.

On the opposite side:

- Install the lower pin.
- Install the lower door.
- Tighten the middle hinge.
- Install the upper door.
- Tighten the spacer and tighten the upper pin.

Ventilation requirements

The airflow behind the appliance must be sufficient.

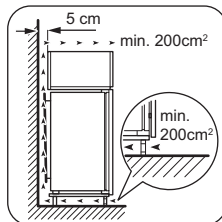

Installing the appliance

Caution! Make sure that the mains cable can move freely.

Do the following steps:

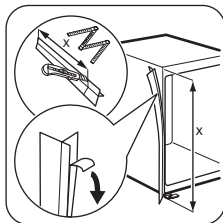

1 If necessary cut the adhesive sealing strip and then apply it to the appliance as shown in figure.

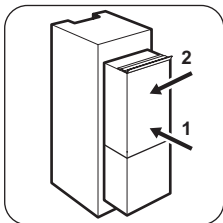

2 Install the appliance in the niche. Push the appliance in the direction of the arrows (1) until the upper gap cover stops against the kitchen furniture. Push the appliance in the direction of the arrows (2) against the cupboard on the opposite side of the hinge.

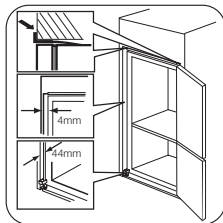

3 Adjust the appliance in the niche. Make sure that the distance between the appliance and the cupboard front edge is 4 mm. The lower hinge cover (in the accessories bag) makes sure that the distance between the appliance and the kitchen furniture is correct. Make sure that the clearance between the appliance and the cupboard is 4 mm.

Open the door. Put the lower hinge cover in position.

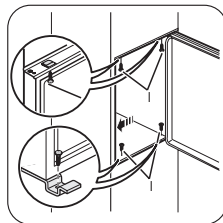

4 Attach the appliance to the niche with 4 screws.

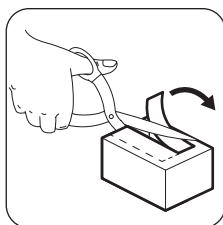

5 Remove the correct part from the hinge cover (E). Make sure to remove the part DX, in the case of right hinge, SX in opposite case.

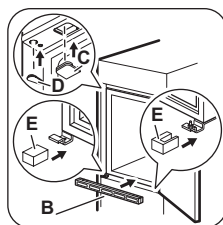

6 Attach the covers (C, D) to the lugs and the hinge holes. Install the vent grille (B). Attach the hinge covers (E) to the hinge.

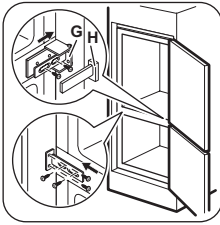

7 Connect the appliance laterally to the kitchen furniture sidewall:

1. Loosen the screws of the part (G) and move the part (G) till the furniture sidewall.
2. Tighten the screws of the part (G) again.
3. Attach the part (H) to the part (G).

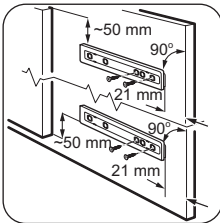

9 Install the part (Ha) on the inner side of the kitchen furniture.

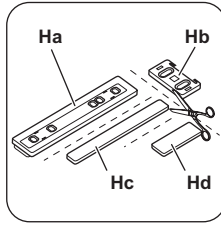

8 Disconnect the parts (Ha), (Hb), (Hc) and (Hd).

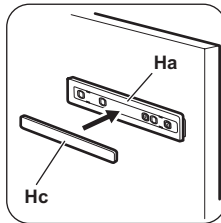

10 Push the part (Hc) on the part (Ha).

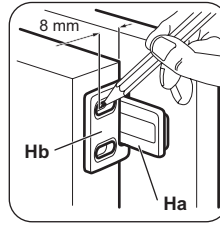

11 Open the appliance door and the kitchen furniture door at an angle of 90°. Insert the small square (Hb) into guide (Ha). Put together the appliance door and the furniture door and mark the holes.

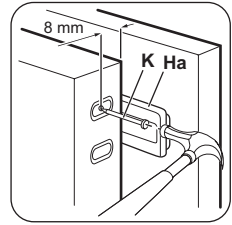

12 Remove the brackets and mark a distance of 8 mm from the outer edge of the door where the nail must be fitted (K).

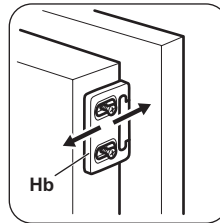

13 Place the small square on the guide again and fix it with the screws supplied. Align the kitchen furniture door and the appliance door by adjusting the part (Hb).

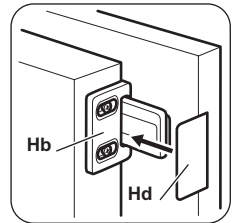

14 Press the part (Hd) on the part (Hb).

Do a final check to make sure that:

- All screws are tightened.
- The magnetic sealing strip is attached tightly to the cabinet.

Important! If the ambient temperature is low (for example, in the Winter), the size of the gasket decreases. The size of the gasket increases when the ambient temperature increases.

Noises

There are some sounds during normal running (compressor, refrigerant circulation).

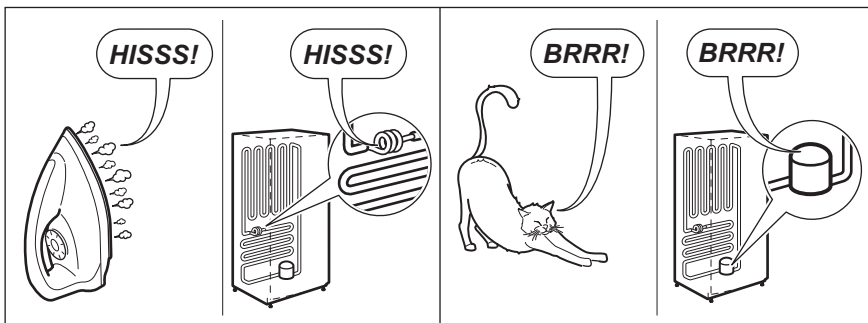
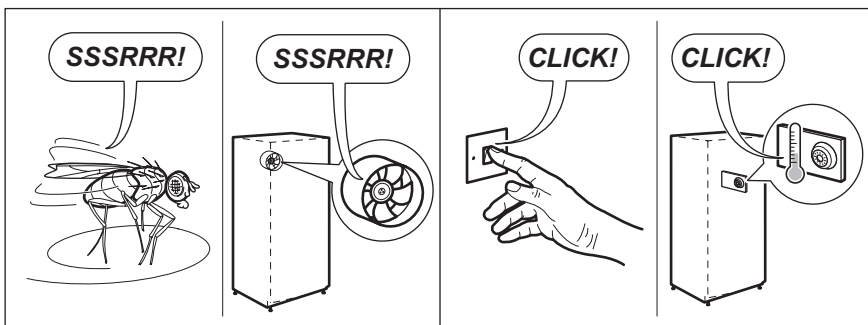
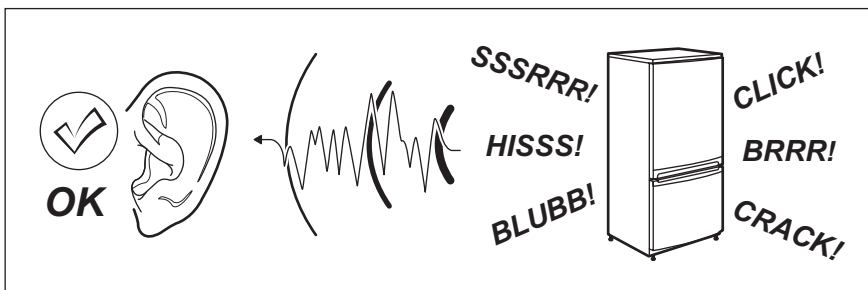

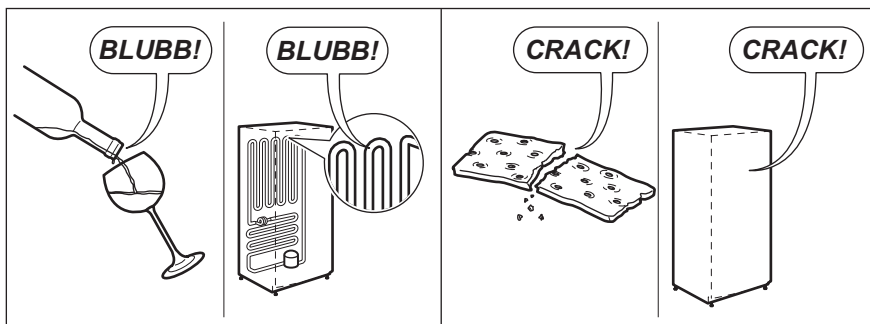

Technical data

Dimension of the recess		
	Height	1780 mm
	Width	560 mm
	Depth	550 mm
Rising Time		22 h
Voltage		230-240 V
Frequency		50 Hz

The technical information are situated in the rating plate on the internal left side of the appliance and in the energy label.



www.zanussi.com/shop



222369509-A-412013