



# CONTENTS

1. SAFETY INFORMATION.....	3
2. SAFETY INSTRUCTIONS.....	5
3. PRODUCT DESCRIPTION.....	7
4. CONTROL PANEL.....	7
5. PROGRAMME TABLE.....	9
6. OPTIONS.....	10
7. SETTINGS.....	12
8. BEFORE FIRST USE.....	13
9. DAILY USE.....	13
10. HINTS AND TIPS.....	14
11. CARE AND CLEANING.....	15
12. TROUBLESHOOTING.....	18
13. TECHNICAL DATA.....	19
14. QUICK GUIDE.....	21

## WE'RE THINKING OF YOU

Thank you for purchasing an Electrolux appliance. You've chosen a product that brings with it decades of professional experience and innovation. Ingenious and stylish, it has been designed with you in mind. So whenever you use it, you can be safe in the knowledge that you'll get great results every time.

Welcome to Electrolux.

**Visit our website for:**



Get usage advice, brochures, trouble shooter, service information:  
**[www.electrolux.com/webselfservice](http://www.electrolux.com/webselfservice)**



Register your product for better service:  
**[www.registerelectrolux.com](http://www.registerelectrolux.com)**



Buy Accessories, Consumables and Original spare parts for your appliance:  
**[www.electrolux.com/shop](http://www.electrolux.com/shop)**

## CUSTOMER CARE AND SERVICE

Always use original spare parts.

When contacting our Authorised Service Centre, ensure that you have the following data available: Model, PNC, Serial Number.

The information can be found on the rating plate.

 Warning / Caution-Safety information

 General information and tips

 Environmental information

Subject to change without notice.

# 1. ⚠ SAFETY INFORMATION

Before beginning the installation and use of this appliance, carefully read the supplied instructions. The manufacturer is not responsible for any injuries or damages that are the result of incorrect installation or usage. Always keep the instructions in a safe and accessible location for future reference.



- Read the supplied instructions.

## 1.1 Children and vulnerable people safety



### **WARNING!**

Risk of suffocation, injury or permanent disability.

- This appliance can be used by children aged from 8 years and above and persons with reduced physical, sensory or mental capabilities or lack of experience and knowledge if they have been given supervision or instruction concerning the use of the appliance in a safe way and understand the hazards involved.
- Children between 3 and 8 years of age and persons with very extensive and complex disabilities shall be kept away unless continuously supervised.
- Children of less than 3 years of age should be kept away unless continuously supervised.
- Do not let children play with the appliance.
- Keep all packaging away from children and dispose of it appropriately.
- Keep detergents away from children.
- Keep children and pets away from the appliance when the door is open.
- If the appliance has a child safety device, it should be activated.
- Children shall not carry out cleaning and user maintenance of the appliance without supervision.

## 1.2 General Safety

- Do not change the specification of this appliance.
- If the tumble dryer is put on top of a washing machine, use the stacking kit. The stacking kit, available from your authorized vendor, can be used only with the appliance specified in the instructions supplied with the accessory. Read it carefully before installation (refer to the Installation leaflet).
- The appliance can be installed as freestanding or below a kitchen counter with correct space (refer to the Installation leaflet).
- Do not install the appliance behind a lockable door, a sliding door or a door with a hinge on the opposite side, that would prevent the appliance door from being fully open.
- The ventilation opening in the base must not be covered by a carpet, mat, or any floor covering.
- **WARNING:** The appliance must not be supplied through an external switching device, such as a timer, or connected to a circuit that is regularly switched on and off by a utility.
- Connect the mains plug to the mains socket only at the end of the installation process. Make sure that the mains plug is accessible after installation.
- If the mains power supply cable is damaged, it must be replaced by the manufacturer, its Authorised Service Centre or similarly qualified persons to avoid an electrical hazard.
- Do not exceed the maximum load of 9 kg (refer to the "Programme chart" chapter).
- Do not use the appliance if items have been soiled with industrial chemicals.
- Wipe away lint or packaging debris that has accumulated around the appliance.
- Do not run the appliance without a filter. Clean the lint filter before or after each use.
- Do not dry unwashed items in the tumble dryer.

- Items that have been soiled with substances such as cooking oil, acetone, alcohol, petrol, kerosene, spot removers, turpentine, waxes and wax removers should be washed in hot water with an extra amount of detergent before being dried in the tumble dryer.
- Items such as foam rubber (latex foam), shower caps, waterproof textiles, rubber backed articles and clothes or pillows fitted with foam rubber pads should not be dried in the tumble dryer.
- Fabric softeners, or similar products, should only be used as specified by the product manufacturer's instructions.
- Remove all objects from items that could be a source of fire ignition such as lighters or matches.
- **WARNING:** Never stop a tumble dryer before the end of the drying cycle unless all items are quickly removed and spread out so that the heat is dissipated.
- Before any maintenance operation, deactivate the appliance and disconnect the mains plug from the socket.

## 2. SAFETY INSTRUCTIONS

### 2.1 Installation

- Remove all the packaging.
- Do not install or use a damaged appliance.
- Follow the installation instructions supplied with the appliance.
- Always take care when moving the appliance as it is heavy. Always use safety gloves and enclosed footwear.
- Do not install or use the appliance where the temperature can be lower than 5°C or higher than 35°C.
- The floor area on which the appliance is to be installed must be flat, stable, heat resistant and clean.
- Make sure that there is air circulation between the appliance and the floor.
- Always keep the appliance vertical when it is being moved.
- The rear surface of the appliance must be put against a wall.

- When the appliance is in its permanent position, check if it is levelled correctly with the aid of a spirit level. If it is not, adjust the feet accordingly.

### 2.2 Electrical connection



#### **WARNING!**

Risk of fire and electric shock.

- Connect the mains plug to the mains socket only at the end of the installation. Make sure that there is access to the mains plug after the installation.
- The appliance must be earthed.
- Make sure that the parameters on the rating plate are compatible with the electrical ratings of the mains power supply.

- Always use a correctly installed shockproof socket.
- Do not use multi-plug adapters and extension cables.
- Do not pull the mains cable to disconnect the appliance. Always pull the mains plug.
- Do not touch the mains cable or the mains plug with wet hands.
- This appliance complies with the E.E.C. Directives.

## 2.3 Use



### **WARNING!**

Risk of injury, electric shock, fire, burns or damage to the appliance.

- This appliance is for household use only.
- Do not dry damaged (torn, frayed) items that contain padding or fillings.
- Only dry fabrics which are suitable for drying in a tumble dryer. Follow the instructions on the fabric label.
- If you have washed your laundry with a stain remover start an extra rinse cycle before you start the dryer.
- Do not drink or prepare food with the condensed water/distilled water. It can cause health problems to people and pets.
- Do not sit or stand on the open door of the appliance.
- Do not dry dripping wet clothes in a tumble dryer.

## 2.4 Internal lighting



### **WARNING!**

Risk of injury.

- Visible LED radiation, do not look directly into the beam.
- The LED lamp is dedicated to drum lighting. This lamp cannot be reused for other lighting purposes.
- To replace the internal lighting, contact the Authorised Service Centre.

## 2.5 Care and cleaning



### **WARNING!**

Risk of injury or damage to the appliance.

- Do not use water spray and steam to clean the appliance.
- Clean the appliance with a moist soft cloth. Only use neutral detergents. Do not use any abrasive products, abrasive cleaning pads, solvents or metal objects.
- To prevent damage to the cooling system be careful when you clean the appliance.

## 2.6 Compressor



### **WARNING!**

Risk of damage to the appliance.

- The compressor and its system in the tumble dryer is filled with the special agent which is free from fluoro-chloro-hydrocarbons. This system must stay tight. The damage of the system can cause a leakage.

## 2.7 Disposal



### **WARNING!**

Risk of injury or suffocation.

- Disconnect the appliance from the mains electrical and water supplies.
- Cut off the mains electrical cable close to the appliance and dispose of it.
- Remove the door catch to prevent children or pets from becoming trapped in the drum.
- Dispose of the appliance in accordance with local requirements for the disposal of Waste Electrical and Electronic Equipment (WEEE).

### 3. PRODUCT DESCRIPTION

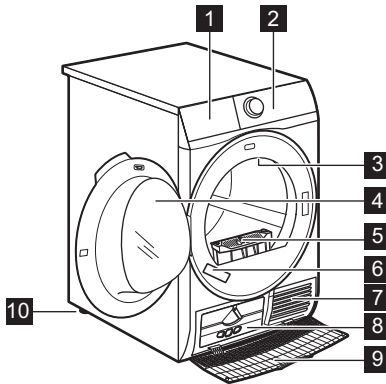

- 1** Water container
- 2** Control panel
- 3** Internal light
- 4** Appliance door
- 5** Filter
- 6** Rating plate
- 7** Airflow slots
- 8** Heat Exchanger lid
- 9** Heat Exchanger cover
- 10** Adjustable feet

**i** For ease of loading laundry or ease of installation the door is reversible. (see separate leaflet).

### 4. CONTROL PANEL

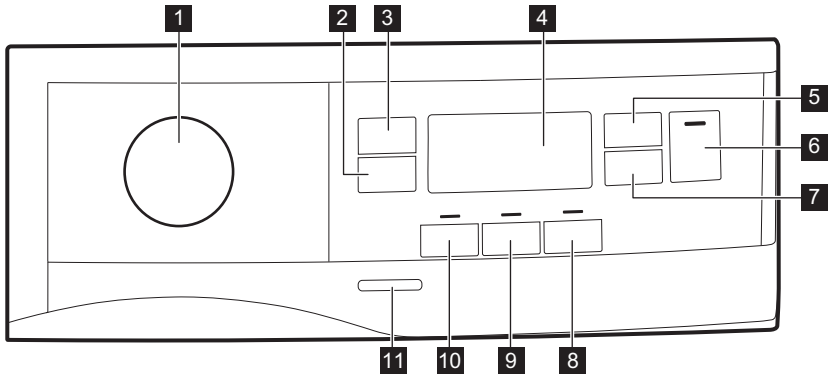







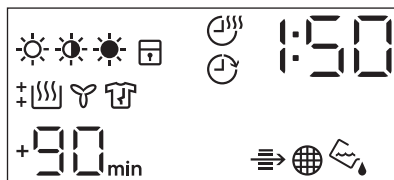



- 1** Programme knob and ● RESET switch
- 2** Extra Anticrease touch button
- 3** Dryness Level touch button
- 4** Display
- 5** Time Dry touch button
- 6** Start/Pause touch button
- 7** Delay Start touch button
- 8** End Alert touch button
- 9** Reverse Plus touch button
- 10** Extra Silent touch button
- 11** On/Off button























 Press the touch buttons with your finger in the area with the symbol or name of the option. Do not wear gloves when you operate the control panel. Make sure that the control panel is always clean and dry.





## 4.1 Display



Symbol on the display	Symbol description
	laundry dryness option: iron dry, cupboard dry, extra dry
	time drying option on
	delay start option on
	indicator: <i>check Heat Exchanger</i>
	indicator: <i>clean filter</i>
	indicator: <i>drain the water container</i>
	child lock on
— — —	wrong selection or knob is in the ● "Reset" position
	indicator: <i>drying phase</i>
	indicator: <i>cooling phase</i>
	indicator: <i>anti-crease phase</i>
1 : 50	programme duration
+30 <sub>min.</sub> , +60 <sub>min.</sub> , +90 <sub>min.</sub> , +2h	extension of default anti-crease phase: +30min, +60min, +90min, +2h)
: 10 - 2 : 00	time drying selection (10min-2h)
1h - 20h	delay start selection (1h-20h)

# 5. PROGRAMME TABLE

Programme	Load <sup>1)</sup>	Properties / Fabric type <sup>2)</sup>
 3) Cotton Eco	9 kg	Cycle to be used to dry cotton with "cotton cupboard" dryness level, with maximum energy saving. /  
Cotton	9 kg	Cycle defined to dry all types of cotton ready to store (cupboard dry). /  
Synthetics	3,5 kg	Synthetic and mixed fabrics. /   
Delicates	4 kg	Delicate fabrics such as viscose, rayon, acrylic, and their blends. /   
Duvet	3 kg	Single or double duvets and pillows (with feather, down or synthetic fillings). /   
Refresh	1kg	Refreshing textiles that were in storage.
Silk 	1 kg	Gentle drying of hand-washable silks. /   
Wool  	1 kg	<p>Woollen fabrics. Gentle drying for hand-washable woollens. Remove items immediately when the programme is completed.</p> <div style="text-align: center;">   <p><b>WOOL HAND WASH SAFE</b></p> </div> <p>The wool drying cycle of this machine has been approved by The Woolmark Company for the drying of wool garments labelled as "hand wash" provided that the garments are dried according to the instructions issued by the manufacturer of this machine. Follow the garment care label for other laundry instructions. M1717</p> <p>The Woolmark symbol is a Certification mark in many countries.</p>

Programme	Load 1)	Properties / Fabric type <sup>2)</sup>
Outdoor 	2 kg	Outdoor clothing, technical, sports fabrics, waterproof and breathable jackets, shell jackets with a removable fleece or inner insulation. Suitable for drying in tumble dryer. / 
Denim	4 kg	Leisure clothing such as jeans, sweat-shirts of different material thicknesses (e.g. at the neck, cuffs and seams). / 
Bedlinen XL	4,5 kg	Up to three bed linen sets, one of which can be double size. / 
Mixed XL	6 kg	Mix of garments made of cotton, cotton-synthetic blend and synthetic fabric. / 

1) The maximum weight refers to dry items.

2) For fabric mark meaning see chapter *HINTS AND TIPS: Preparing the laundry*.

3) The  Cotton Cupboard Dry ECO programme is the "Standard cotton programme" according to Commission Regulation EU No. 392/2012. It is suitable for drying normal wet cotton laundry and it is the most efficient programme in terms of energy consumption for drying wet cotton laundry.



## 6. OPTIONS

### 6.1 Extra Antcrease

Extends the anti-crease phase by 30,60, 90 or 2 hours at the end of the drying cycle. This function reduces creases. The laundry can be removed during the anti-crease phase.

### 6.2 Dryness Level

This function helps to increase dryness of the laundry. There are 3 options:

-  Extra Dry
-  Cupboard Dry
-  Iron Dry

### 6.3 Time Dry

You can set the programme duration, from a minimum of 10 minutes to a maximum of 2 hours. The required duration is related to the quantity of laundry in the appliance.



We recommend that you set a short duration for small quantities of laundry or for only one item.

### 6.4 Time Dry on Wool programme

Option suitable for Wool programme to adjust final dryness level.

### 6.5 End Alert

The buzzer sounds at the:

- cycle end
- start and end of the anti-crease phase
- cycle interruption

The buzzer function is by default always on. You can use this function to activate or deactivate the sound.



You can activate the End Alert option with all programmes.









## 6.6 Reverse Plus

Increase drum reversing frequency to reduce items twisting and entanglement. To increase uniformity of drying result and help reduce creases. Recommended for large or long items (e.g. sheets, trousers, long dresses)"

## 6.7 Extra Silent

The appliance operates with low noise without effect on the drying quality. The appliance operates slowly with longer cycle time.

## 6.8 Options table

Programmes <sup>1)</sup>	☀️ Dryness Level			 Extra Anti-crease	 Extra Silent	 Reverse Plus	 Time Dry
	☀️	☀️	☀️				
 Cotton <b>Eco</b>		■		■			
Cotton	■	■	■	■	■	■	■
Synthetics	■	■	■	■	■	■	■
Delicates		■		■			
Duvet		■					
Refresh				■			
Silk 		■		■			
Wool  							■ <sup>2)</sup>
Outdoor 		■					
Denim	■	■		■		■	
Bedlinen <b>XL</b>	■	■	■	■		■	
Mixed <b>XL</b>	■	■		■		■	■

<sup>1)</sup> Together with the programme you can set 1 or more options. To activate or deactivate them, press the related touch button.

<sup>2)</sup> See chapter OPTIONS: Time Drying on Wool programme

## 7. SETTINGS

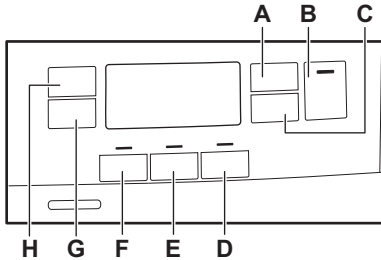

- A. Time Dry touch button
- B. Start/Pause touch button
- C. Delay Start touch button
- D. End Alert touch button
- E. Reverse Plus touch button
- F. Extra Silent touch button
- G. Extra Anticrease touch button
- H. Dryness Level touch button

### 7.1 Child lock function

This option prevents children playing with the appliance while a programme is operating. The touch buttons are locked.

Only the on/off button is unlocked.

#### Activating the child lock option:

1. Press the on/off button to activate the appliance.
2. Press and hold touch button (D) for a few seconds.

The child lock indicator comes on.



It is possible to deactivate the child lock option while a programme operates. Press and hold the same touch buttons until the child lock indicator goes off. The Child Lock function isn't available for 8 s after switching on the appliance.

### 7.2 Adjustment of the remaining moisture

To change the default degree of remaining moisture:

1. Press the on/off button to activate the appliance.
2. Wait approximately 8 seconds.
3. Press and hold buttons (F) and (E) at the same time.

One of these indicators comes on:

- - - maximum dryness
  - - - more dry laundry
  - - - standard dry laundry
4. Press and hold buttons (F) and (E) again until the indicator of the correct level comes on.
  5. After 5 s the display returns to normal mode.

Dryness level	Display symbol
-  - maximum dryness	+
-  - more dry laundry	+
-  - standard dry laundry	

### 7.3 Water container indicator

By default, the water container indicator is on. It comes on when the programme is completed or when it is necessary to empty the water container.



If a draining kit is installed (additional accessory), the appliance automatically drains the water from the water container. In this case we recommend that you deactivate the indicator of the water container.

## Deactivating the water container indicator:

1. Press the on/off button to activate the appliance.
2. Wait approximately 8 seconds.
3. Press and hold touch buttons (H) and (G) at the same time.

The display shows one of these 2 configurations:

- The display shows "Off". After 5 s the display returns to normal mode.
- The display shows "On". After 5 s the display returns to normal mode.

## 8. BEFORE FIRST USE



Rear drum packaging is removed automatically when dryer is activated for the first time. Possible to hear some noise.

Before you use the appliance for the first time:

- Clean the tumble dryer drum with a moist cloth.
- Start a 1 hour programme with moist laundry.



At the beginning of the drying cycle (first 3-5 min) there could be a slightly higher sound level. This is due to the compressor starting up. This is normal for compressor powered appliances such as refrigerators and freezers.

## 9. DAILY USE

### 9.1 Start a programme without delay start

1. Prepare the laundry and load the appliance.



#### CAUTION!

Make sure that when you close the door, the laundry does not get caught between the appliance door and the rubber seal.

2. Press the on/off button to activate the appliance.
3. Set the correct programme and options for the type of load.

The display shows the programme duration.



The drying time you see on the display, when the cotton programme is selected, is related to the load of 5 kg and standard conditions. Real drying time will depend on type of the load (quantity and composition), the room temperature and the humidity of your laundry after spin drying phase.

4. Press the Start/Pause touch button. The programme starts.

### 9.2 Starting the programme with delay start

1. Set the correct programme and options for the type of load.
2. Press the delay start button again and again until the display shows the delay time you want to set.



You can delay the start of a programme from a minimum of 1 hour to a maximum of 20 hours.

3. Press the Start/Pause touch button. The display shows the countdown of the delay start. When the countdown is completed, the programme starts.

### 9.3 Change a programme



1. Press the on/off button to deactivate appliance
2. Press the on/off button to activate the appliance.
3. Set the programme.

#### Alternatively:

1. Rotate the selector knob to the ● "Reset" position.
2. Wait for 1 second. The display shows .
3. Set the programme.

### 9.4 At the end of the programme

When the programme is completed:



- An intermittent acoustic signal operates.
- The display shows .
- The indicator  is on.
- The indicators Filter and Tank may come on.
- The Start/Pause indicator is on.

The appliance continues to operate with the anti-crease phase for approximately 30 minutes or more if Extra Anticrease option was set (see chapter *Option - Extra Anticrease*).

The anti-crease phase reduces creasing.

You can remove the laundry before the anti-crease phase is completed. We recommend, for better results, that you remove the laundry when the phase is almost completed.

When the anti-crease phase is completed:

- The display still shows .
  - The indicator  is off.
  - The indicators Filter and Tank remain on.
  - Start/Pause indicator goes off.
1. Press the on/off button to deactivate the appliance.
  2. Open the appliance door.
  3. Remove the laundry.
  4. Close the appliance door.



Always clean the filter and empty the water container when a programme is completed.

### 9.5 Stand-by function

To reduce energy consumption, this function automatically deactivates the appliance:

- After 5 minutes if you do not start the programme.
- After 5 minutes from the end of the programme.







The time is reduced to 30 seconds if the selector knob is pointing to ● "Reset" position.

## 10. HINTS AND TIPS

### 10.1 Preparing the laundry

- Close the zips.
- Close the fasteners of duvet covers.
- Do not dry ties or ribbons loose (e.g. apron ribbons). Tie them before you start a programme.
- Remove all items from pockets.
- Turn items with the internal layer made of cotton inside out. Cotton layer must be faced outwards.
- Always set the programme suitable for the type of laundry.
- Do not put light and dark colours together.
- Use suitable programme for cottons, jersey and knitwear to reduce shrinkage.
- Do not exceed the maximum load stated in the programmes chapter or shown on the display.

- Dry only the laundry that is suitable for tumble drying. Refer to the fabric label on the items.
- Do not dry large and small items together. Small items can be trapped inside the large items and remain wet.

Fabric label	Description
	Laundry is suitable for tumble drying.
	Laundry is suitable for tumble drying at higher temperatures.
	Laundry is suitable for tumble drying at low temperatures only.
	Laundry is not suitable for tumble drying.

## 11. CARE AND CLEANING

### 11.1 Cleaning the filter

1.

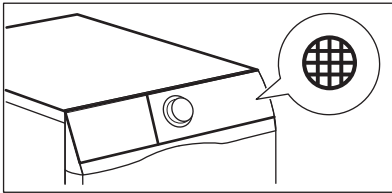

2.

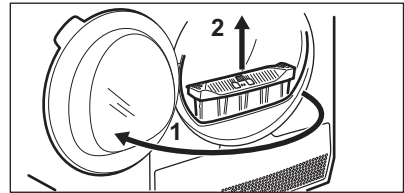

3.

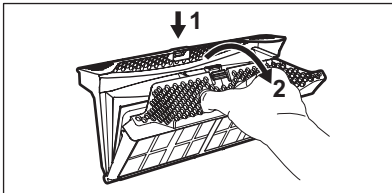

4.

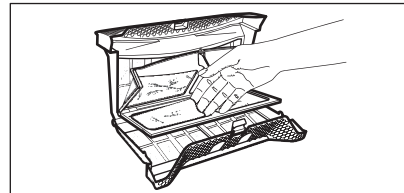

5. 1)

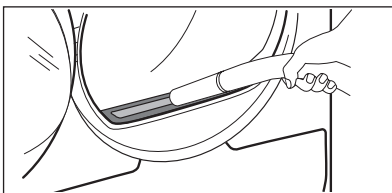

6.

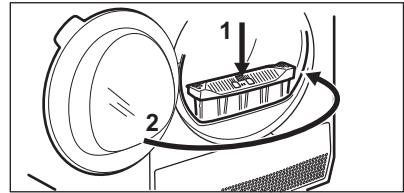

1) If necessary remove fluff from the filter socket and gasket. You can use a vacuum cleaner.

## 11.2 Emptying the water container

1.

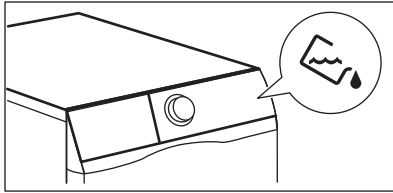

2.

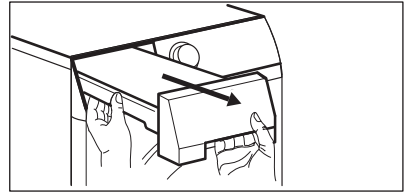

3.

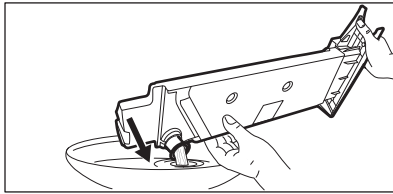

4.

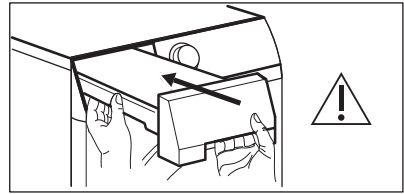

You can use the water from the water container as an alternative to distilled water (e.g. for steam ironing). Before you use the water, remove dirt residues with a filter.

## 11.3 Cleaning the Heat Exchanger

1.

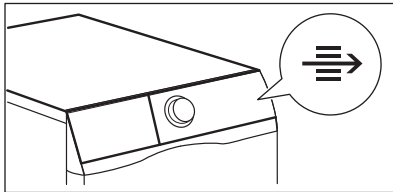

2.

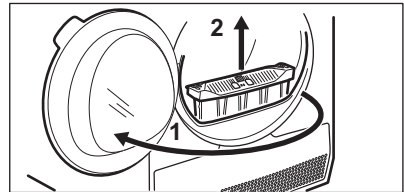

3.

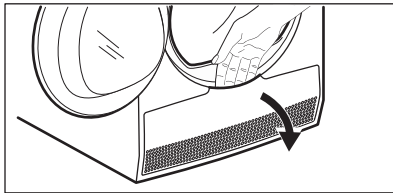

4.

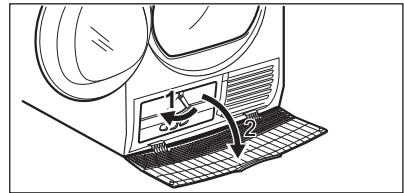

5.

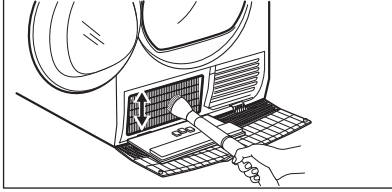

6.

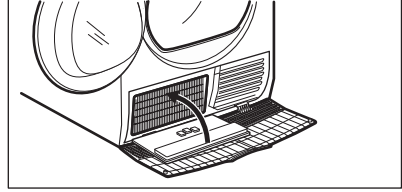

7.

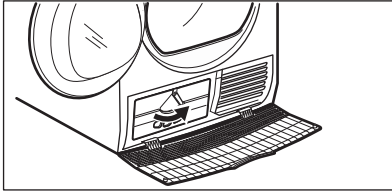

8.

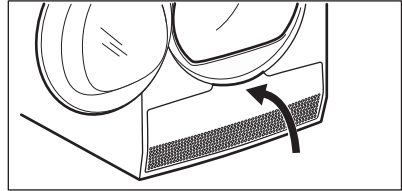

9.

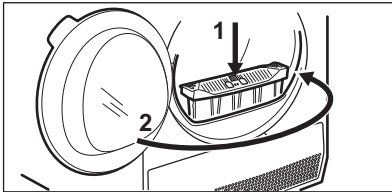
**CAUTION!**

Do not touch the metal surface with bare hands. Risk of injury. Wear protective gloves. Clean carefully to avoid damaging the metal surface.

**11.4 Cleaning the drum****WARNING!**

Disconnect the appliance before you clean it.

Use a standard neutral soap detergent to clean the inner surface of the drum and drum lifters. Dry the cleaned surfaces with a soft cloth.

**CAUTION!**

Do not use abrasive materials or steel wool to clean the drum.

**11.5 Cleaning the control panel and housing**

Use a standard neutral soap detergent to clean the control panel and housing.

Use a moist cloth to clean. Dry the cleaned surfaces with a soft cloth.

**CAUTION!**

Do not use furniture cleaning agents or cleaning agents which can cause corrosion.

**11.6 Cleaning the airflow slots**

Use a vacuum cleaner to remove fluff from the airflow slots.

## 12. TROUBLESHOOTING

Problem	Possible solution
You cannot activate the appliance.	Make sure that the mains plug is connected to the mains socket.
	Check fuse in fuse box (domestic installation).
The programme does not start.	Press Start/Pause.
	Make sure that the appliance door is closed.
The appliance door does not close.	Make sure that the installation of the filter is correct.
	Make sure that the laundry is not caught between the appliance door and the rubber seal.
The appliance stops during operation.	Make sure that the water container is empty. Press Start/Pause to start the programme again.
	Load is too small, increase the load or use the Time Drying programme.
The cycle time is too long or unsatisfactory drying result. <sup>1)</sup>	Make sure that the weight of the laundry is suitable for the duration of the programme.
	Make sure that the filter is clean.
	The laundry is too wet. Spin the laundry in the washing machine again.
	Ensure that the room temperature is higher than +5°C and lower than +35°C. Optimal room temperature is 19°C to 24°C.
	Set the Time Drying or the Extra Dry programme. <sup>2)</sup>
The display shows — — —.	If you want to set a new programme, deactivate and activate the appliance.
	Make sure that the options are suitable for the programme.
The display shows Error code (e.g. <b>E51</b> ).	Deactivate and activate the appliance. Start a new programme. If the problem occurs again, contact the Service centre.

<sup>1)</sup> After maximum 5 hours, the programme ends automatically.

<sup>2)</sup> It can happen that some area remains humid when drying big items (e.g. bed sheets).

## 12.1 If the drying results are not satisfactory

- The set programme was incorrect.
- The filter is clogged.
- The Heat Exchanger is clogged.
- There was too much laundry in the appliance.
- The drum is dirty.
- Incorrect setting of the conductivity sensor ( See chapter "*Settings - Adjustment of the remaining laundry moisture degree*" for better setting).
- The airflow slots are clogged.
- Room temperature is too low or too high ( optimal room temperature 19°C to 24°C )

## 13. TECHNICAL DATA

Height x Width x Depth	850 x 600 x 600 mm (maximal 665 mm)
Max. depth with the appliance door open	1100 mm
Max. width with the appliance door open	950 mm
Adjustable height	850 mm (+ 15 mm - feet regulation)
Drum volume	118 l
Maximum load volume	<b>9 kg</b>
Voltage	230 V
Frequency	50 Hz
Sound power level	65 dB
Total power	900 W
Energy efficiency class	<b>A++</b>
Energy consumption on the standard cotton programme with the full load. <sup>1)</sup>	<b>2,21 kWh</b>
Energy consumption on the standard cotton programme with the partial load. <sup>2)</sup>	<b>1,16 kWh</b>
Annual energy consumption <sup>3)</sup>	258,7 kWh
Left-on mode power absorption	0,13 W
Off mode power absorption	0,13 W
Type of use	Household
Allowed ambient temperature	+ 5°C to + 35°C
Level of protection against ingress of solid particles and moisture ensured by the protective cover, except where the low voltage equipment has no protection against moisture	<b>IPX4</b>
This product contains fluorinated greenhouse gases, hermetically sealed	
Gas designation	R134a

Weight	0,260 kg
Global-warming potential (GWP)	1430

- 1) With reference to EN 61121. 9 kg of cotton centrifuged at 1000 rpm.
- 2) With reference to EN 61121. 4,5 kg of cotton centrifuged at 1000 rpm.
- 3) Energy consumption per year in kWh, based on 160 drying cycles of the standard cotton programme at full and partial load, and the consumption of the low-power modes. Actual energy consumption per cycle will depend on how the appliance is used (REGULATION (EU) No. 392/2012).

### 13.1 Consumption data

Programme	Spun at / residual humidity	Drying time <sup>1)</sup>	Energy consumption <sup>2)</sup>
<b>Cotton Eco 9 kg</b>			
Cupboard Dry	1400 rpm / 50%	160 min.	1,88 kWh
	1000 rpm / 60%	185 min.	2,21 kWh
Iron Dry	1400 rpm / 50%	107 min.	1,27 kWh
	1000 rpm / 60%	129 min.	1,57 kWh
<b>Cotton Eco 4,5 kg</b>			
Cupboard Dry	1400 rpm / 50%	88 min.	0,97 kWh
	1000 rpm / 60%	103 min.	1,16 kWh
<b>Synthetics 3,5 kg</b>			
Cupboard Dry	1200 rpm / 40%	56 min.	0,56 kWh
	800 rpm / 50%	69 min.	0,78 kWh

- 1) For partial loads, the cycle time is shorter and appliance uses less energy.
- 2) Improper ambient temperature and/or poorly centrifuged laundry can prolong cycle time and increase the energy consumption.

## 14. QUICK GUIDE

### 14.1 Daily use

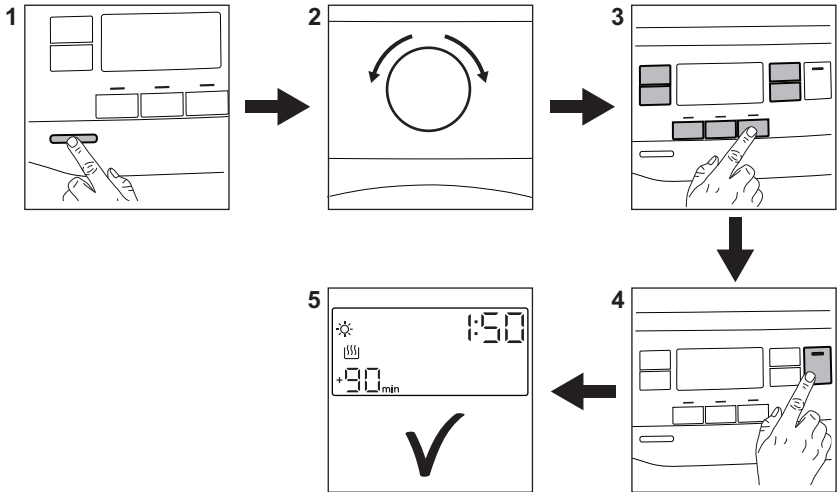





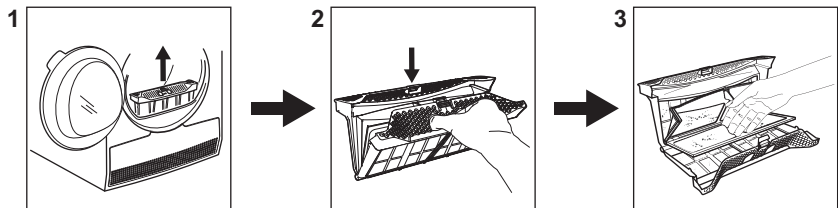



























1. Push the On/Off button to turn on the appliance.
2. Use the programme dial to set the programme.
3. Together with the programme you can set 1 or more special options. To activate or deactivate an option touch the relevant button.
4. To start the programme, Touch the **Start/Pause** button.
5. The appliance starts.

### 14.2 Cleaning the filter



At the end of each cycle the filter symbol  appears on the display and you must clean the filter.

### 14.3 Programme table

Programme	Load <sup>1)</sup>	Properties / Fabric type
 <b>2) Cotton Eco</b>	<b>9 kg</b>	Cycle to be used to dry cotton with "cotton cupboard" dryness level, with maximum energy saving. /  
Cotton	<b>9 kg</b>	Cycle defined to dry all types of cotton ready to store (cupboard dry). /  
Synthetics	<b>3,5 kg</b>	Synthetic and mixed fabrics. /   
Delicates	<b>4 kg</b>	Delicate fabrics such as viscose, rayon, acrylic, and their blends. /   
Duvet	<b>3 kg</b>	Single or double duvets and pillows (with feather, down or synthetic fillings). /   
Refresh	<b>1kg</b>	Refreshing textiles that were in storage.
Silk 	<b>1 kg</b>	Gentle drying of hand-washable silks. /   
Wool  	<b>1 kg</b>	Woollen fabrics. Gentle drying for hand-washable woollens. Remove items immediately when the programme is completed.
Outdoor 	<b>2 kg</b>	Outdoor clothing, technical, sports fabrics, waterproof and breathable jackets, shell jackets with a removable fleece or inner insulation. Suitable for drying in tumble dryer. /   
Denim	<b>4 kg</b>	Leisure clothing such as jeans, sweat-shirts of different material thicknesses (e.g. at the neck, cuffs and seams). /   
Bedlinen <b>XL</b>	<b>4,5 kg</b>	Up to three bed linen sets, one of which can be double size. /   
Mixed <b>XL</b>	<b>6 kg</b>	Mix of garments made of cotton, cotton-synthetic blend and synthetic fabric. /   

1) The maximum weight refers to dry items.

2) The  Cotton Cupboard Dry ECO programme is the "Standard cotton programme" according to Commission Regulation EU No. 392/2012. It is suitable for drying normal wet cotton laundry and it is the most efficient programme in terms of energy consumption for drying wet cotton laundry.

## 15. ENVIRONMENTAL CONCERNS

Recycle materials with the symbol . Put the packaging in relevant containers to recycle it. Help protect the environment and human health by recycling waste of electrical and electronic appliances. Do not dispose of

appliances marked with the symbol  with the household waste. Return the product to your local recycling facility or contact your municipal office.

[www.electrolux.com/shop](http://www.electrolux.com/shop)



136954510-A-202018

