

User Manual

GETTING STARTED? EASY.



ZWD86SB4PW

EN User Manual
Washer Dryer

ZANUSSI

VISIT OUR WEBSITE TO:



Get usage advice, brochures, trouble shooter, service and repair information:
www.zanussi.com/support

SAFETY INFORMATION

Before the installation and use of the appliance, carefully read the supplied instructions. The manufacturer is not responsible for any injuries or damage that are the result of incorrect installation or usage. Always keep the instructions in a safe and accessible location for future reference.

CHILDREN AND VULNERABLE PEOPLE SAFETY



WARNING!

Risk of suffocation, injury or permanent disability.

- This appliance can be used by children aged from 8 years and above and persons with reduced physical, sensory or mental capabilities or lack of experience and knowledge if they have been given supervision or instruction concerning the use of the appliance in a safe way and understand the hazards involved.
- Children between 3 and 8 years of age and persons with very extensive and complex disabilities shall be kept away from the appliance unless continuously supervised.
- Children of less than 3 years of age should be kept away from the appliance unless continuously supervised.
- Do not let children play with the appliance.
- Keep all packaging away from children and dispose of it appropriately.
- Keep detergents away from children.
- Keep children and pets away from the appliance when the door is open.
- If the appliance has a child safety device, it should be activated.
- Children shall not carry out cleaning and user maintenance of the appliance without supervision.

GENERAL SAFETY

- Do not change the specification of this appliance.

- This appliance is intended to be used in household and similar applications such as:
 - staff kitchen areas in shops, offices and other working environments;
 - by clients in hotels, motels, bed & breakfast and other residential type environments;
 - areas for communal use in blocks of flats or in launderettes.
- The appliance shall be installed as a freestanding product or below the kitchen worktop if space margins permit.
- Do not install the appliance behind a lockable door, a sliding door or a door with a hinge on the opposite side, that would prevent the appliance door from being fully open.
- Connect the mains plug to the mains socket only at the end of the installation process. Make sure that the mains plug is accessible after installation.
- The ventilation opening in the base must not be covered by a carpet, mat, or any floor covering.
- **CAUTION:** The appliance must not be supplied through an external switching device, such as a timer, or connected to a circuit that is regularly switched on and off by a utility.
- Ensure good air ventilation in the room where the appliance is installed to avoid the backflow of unwanted gases into the room from appliances burning gas or other fuels, including open fires.
- Exhaust air must not be discharged into a flue which is used for exhausting fumes from any appliances burning gas or other fuels.
- The operating water pressure at the water entry point from the outlet connection must be between 0.5 bar (0.05 MPa) and 8 bar (0.8 MPa).
- Do not exceed the maximum load of 8 kg (refer to the "Programme chart" chapter).
- The appliance must be connected to the water mains using the new supplied hose sets, or other new hose sets supplied by the Authorised Service Centre.
- Old hose sets must not be reused.

- If the mains power supply cable is damaged, it must be replaced by the manufacturer, its Authorised Service Centre or similarly qualified persons to avoid an electrical hazard.
- Wipe away lint or packaging debris that has accumulated around the appliance.
- Items that have been soiled with substances such as vegetable or mineral oil, acetone, alcohol, petrol, kerosene, spot removers, turpentine, waxes and wax removers should be washed separately with an extra amount of detergent before being dried in the washer dryer.
- Do not use the appliance if items have been soiled with industrial chemicals.
- Do not dry unwashed items in the wash dryer.
- Items such as foam rubber (latex foam), shower caps, waterproof textiles, and rubber backed articles and clothes, or pillows fitted with foam rubber pads should not be dried in the washer dryer.
- Fabric softeners, or similar products, should only be used as specified by the product manufacturer's instructions.
- Remove all objects from items that could be a source of fire ignition such as lighters or matches.
- Never stop the washer dryer before the end of the drying cycle unless all items are quickly removed and separated so that residual heat can dissipate.
- The final part of the washer dryer cycle takes place without heat (cool down cycle) to ensure that items reach a temperature that will not cause damage to them.
- Do not use high pressure water sprays and/or steam to clean the appliance.
- Clean the appliance with a moist cloth. Use only neutral detergents. Do not use abrasive products, abrasive cleaning pads, solvents or metal objects.
- Before any maintenance operation, deactivate the appliance and disconnect the mains plug from the socket.

SAFETY INSTRUCTIONS

INSTALLATION



The installation must comply with relevant national regulations.

- Follow the installation instructions supplied with the appliance.
- Do not install or use the appliance where the temperature can be less than 0°C or where it is exposed to the weather.
- Always keep the appliance vertical when it is being moved.
- Make sure that there is air circulation between the appliance and the floor.
- Remove all the packaging and the transit bolts.
- The floor area on which the appliance is to be installed must be flat, stable, heat resistant and clean.
- Make sure the transit bolts in a safe place. If the appliance is to be moved in the future they must be reattached to lock the drum to prevent an internal damage.
- Always take care when moving the appliance as it is heavy. Always use safety gloves and enclosed footwear.
- Do not install or use a damaged appliance.
- Do not install the appliance where the appliance door cannot be fully opened.
- Adjust the feet to have the necessary space between the appliance and the flooring.
- When the appliance is in its permanent position, check if it is levelled correctly with the aid of a spirit level. If it is not, adjust the feet accordingly.

ELECTRICAL CONNECTION



WARNING! Risk of fire and electric shock.

- The appliance must be earthed.
- Always use a correctly installed shockproof socket.
- Do not use multi-plug adapters and extension cables.
- Do not pull the mains cable to disconnect the appliance. Always pull the mains plug.
- Do not touch the mains cable or the mains plug with wet hands.
- This appliance is fitted with a 13 A mains plug. If it is necessary to change the mains plug fuse, use only a 13 A ASTA (BS 1362) fuse (UK and Ireland only).

WATER CONNECTION

- Do not cause damage to the water hoses.

- Before connection to new pipes, pipes not used for a long time, where repair work has been carried out or new devices fitted (water meters, etc.), let the water flow until it is clean and clear.
- Ensure that there are no visible water leaks during and after the first use of the appliance.

USE



WARNING! Risk of injury, electric shock, fire, burns or damage to the appliance.

- Do not put flammable products or items that are wet with flammable products in, near or on the appliance.
- Do not touch the glass door while a programme operates. The glass can get hot.
- Do not dry damaged (torn, frayed) items that contain padding or fillings.
- If laundry has been washed with a stain remover, carry out an additional rinse cycle before starting a drying cycle.
- Make sure that all metal objects are removed from the laundry.
- Dry only fabrics that are suitable to dry in the appliance. Follow the cleaning instruction on the item label.
- Do not sit or stand on the open door of the appliance.
- Do not dry dripping wet clothes in the appliance.
- Do not let hot items to touch the plastic parts of the appliance.
- Remove a detergent ball (if used) before starting a drying programme.
- Do not use a detergent ball if setting a non-stop programme.

INTERNAL LIGHTING



WARNING! Risk of injury.

- Concerning the lamp(s) inside this product and spare part lamps sold separately: These lamps are intended to withstand extreme physical conditions in household appliances, such as temperature, vibration, humidity, or are intended to signal information about the operational status of the appliance. They are not intended to be used in other applications and are not suitable for household room illumination.
- To replace the internal lighting, contact the Authorised Service Centre.

SERVICE

- To repair the appliance contact the Authorised Service Centre. Use original spare parts only.
- Please note that self-repair or non-professional repair can have safety consequences and might void the guarantee.
- The following spare parts will be available for 10 years after the model has been discontinued: motor and motor brushes, transmission between motor and drum, pumps, shock absorbers and springs, washing drum, drum spider and related ball bearings, heaters and heating elements, including heat pumps, piping and related equipment including hoses, valves, filters and aquastops, printed circuit boards, electronic displays, pressure switches, thermostats and sensors, software and firmware including reset

software, door, door hinge and seals, other seals, door locking assembly, plastic peripherals such as detergent dispensers. Please note that some of these spare parts are only available to professional repairers, and that not all spare parts are relevant for all models.

DISPOSAL

- Disconnect the appliance from the mains electrical and water supplies.
- Cut off the mains electrical cable close to the appliance and dispose of it.
- Remove the door catch to prevent children or pets from becoming trapped in the drum.
- Dispose of the appliance in accordance with local requirements for the disposal of Waste Electrical and Electronic Equipment (WEEE).

PRODUCT DESCRIPTION

APPLIANCE OVERVIEW

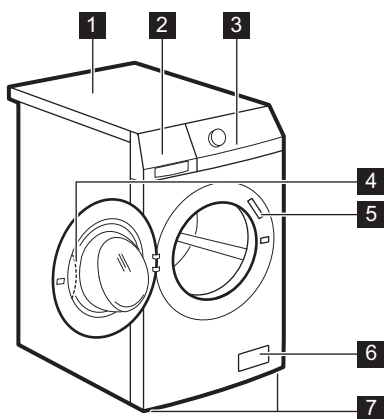

- 1 Worktop
- 2 Detergent dispenser
- 3 Control panel
- 4 Door handle
- 5 Rating plate
- 6 Quick Reminder sticker
- 7 Drain pump filter
- 8 Feet for levelling the appliance

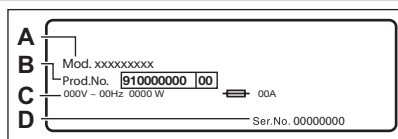

The rating plate reports the model name (A), product number (B), electrical ratings (C) and serial number (D).

TECHNICAL DATA

Dimension	Width/ Height/ Total depth	59.7 cm /84.7 cm /55.7 cm
-----------	----------------------------	---------------------------

Electrical connection	Voltage Overall power Fuse Frequency	230-240 V 2200 W 13 A 50 Hz
Level of protection against ingress of solid particles and moisture ensured by the protective cover, except where the low voltage equipment has no protection against moisture		IPX4
Water supply ¹⁾		Cold water
Water supply pressure ²⁾	Minimum Maximum	0.5 bar (0.05 MPa) 8 bar (0.8 MPa)
Maximum wash load	Cotton	8 kg
Maximum dry load	Cotton Synthetics	4 kg 3 kg
Spin Speed	Maximum spin speed	1551 rpm

1) Connect the water inlet hose to a water tap with a 3/4" thread.

2) The appliance works correctly if the water pressure is not lower than 0.05 MPa (0.5 bar). If you cannot connect the water inlet hose to the cold water tap of the primary hydraulic system, connect it to your domestic cold water storage system. Make sure not to exceed a distance of 5.02 m (16.5 ft) between the appliance inlet hose and the bottom of the water storage tank.

INSTALLATION



WARNING! Refer to Safety chapters.

UNPACKING



WARNING! Remove all the packaging and the transit bolts before installing the appliance.

1. Use the gloves. Remove the external film. If necessary, use a cutter.

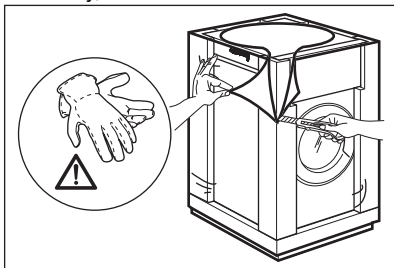

2. Remove the cardboard top. Remove the polystyrene packaging materials.

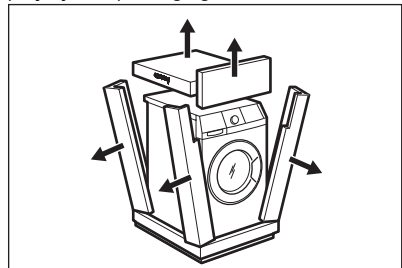

3. Remove the internal film.

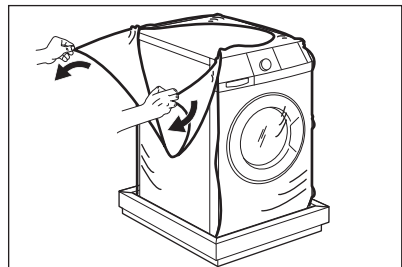

4. Open the door. Remove the polystyrene piece from the door seal and all the items from the

drum.

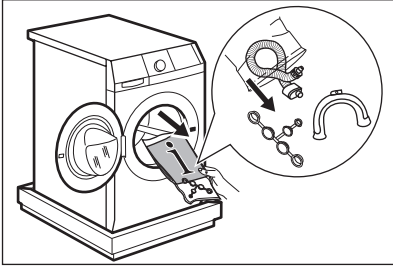

5. Put one of the polystyrene packaging elements on the floor behind the appliance. Carefully put down the appliance with the rear side on it. Make sure not to damage the hoses.

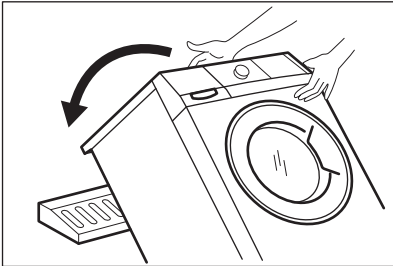

6. Remove the polystyrene protection from the bottom. Pull up the appliance in vertical position.

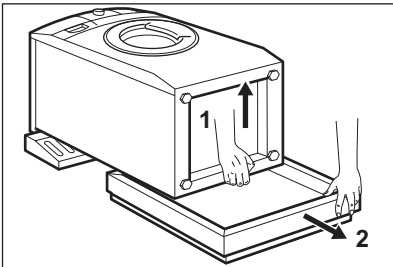

7. Remove the power supply cable and the drain hose from the hose holders.

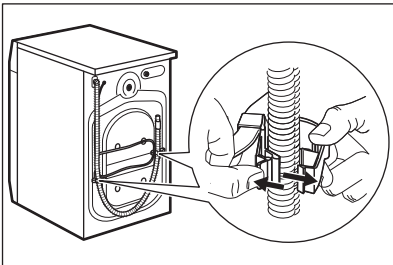

8. Remove the three bolts. Use the key supplied with the appliance. Pull out the plastic spacers.

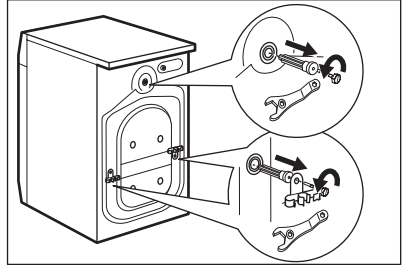

9. Put the plastic caps in the holes. You can find these caps in the user manual bag.

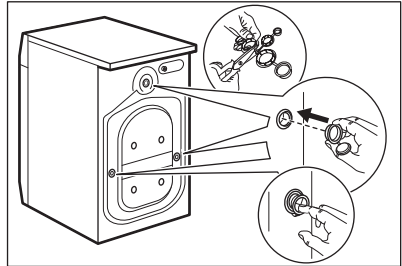

We recommend that you keep the packaging and the transit bolts for any movements of the appliance.

INFORMATION FOR INSTALLATION

Positioning and levelling

Adjust the appliance correctly to prevent vibration, noise and movement of the appliance when it operates.

1. Install the appliance on a flat hard floor. The appliance must be levelled and stable. Make sure that the appliance does not touch the wall or other units and there is air circulation below the appliance.
2. Loosen or tighten the feet to adjust the level. All feet must rest firmly on the floor.



WARNING! Do not put cardboard, wood or equivalent materials below the appliance feet to adjust the level.

The inlet hose



CAUTION! Make sure there is no damage to hoses and there are no leaks from the couplings. Do not use an extension hose if the inlet hose is too short. Contact the service centre for a replacement inlet hose.

1. Connect the water inlet hose to the back of the appliance.

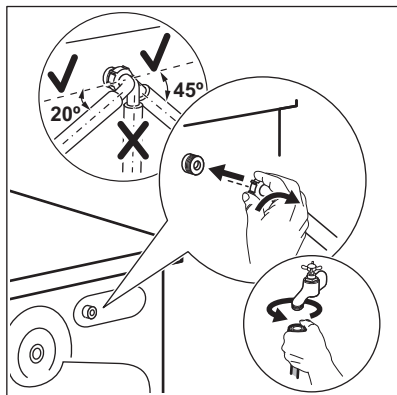

2. Position it toward left or right depending on the position of the water tap. Make sure that the inlet hose is not in vertical position.

3. If necessary, loosen the ring nut to set it in the correct position.

4. Connect the water inlet hose to the cold water tap with 3/4" thread.

Water drainage

The drain hose should stay at a height of no less than 60 cm and not more than 100 cm.



You can extend the drain hose to maximum 400 cm. Contact the authorised service centre for the other drain hose and the extension.

It is possible to connect the drain hose in different ways:

1. Make a U shape with the drain hose and put it around the plastic hose guide.

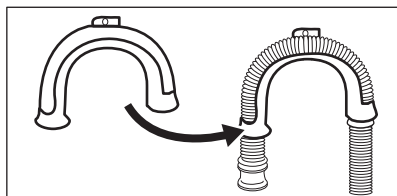

2. On the edge of a sink - Fasten the guide to the water tap or to the wall.

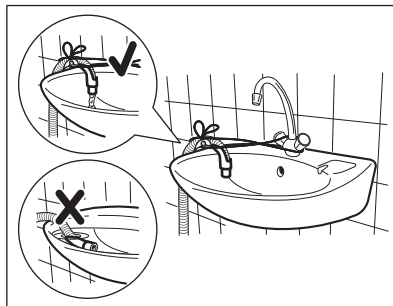

Make sure that the plastic guide cannot move when the appliance drains and the drain hose end is not immersed in the water. There may be a return of dirty water into the appliance.

3. If the end of the drain hose looks like this (see the picture), you can push it directly into the stand pipe.

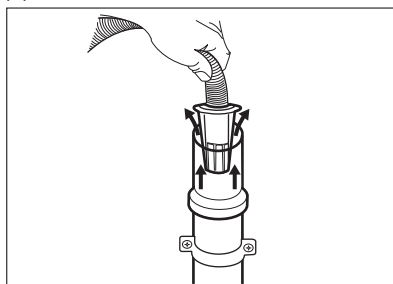

4. To a stand pipe with vent hole - Insert the drain hose directly into a drain pipe. Refer to the illustration.

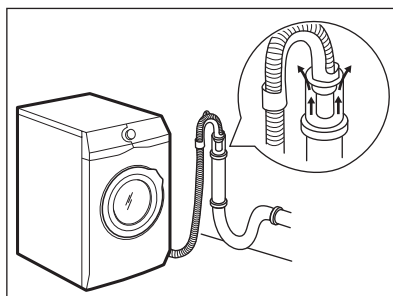

The end of the drain hose must always be ventilated, i.e. the inner diameter of the drain pipe (min. 38 mm - min. 1.5") must be larger than the external diameter of the drain hose.

5. Without the plastic hose guide, to a sink spigot- Put the drain hose in the spigot and tighten it with a clamp. Refer to the illustration.

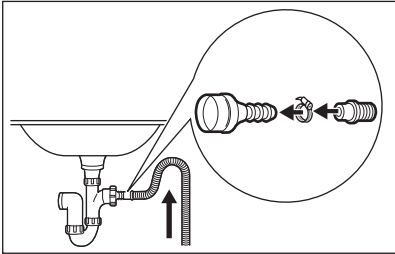

Make sure that the drain hose makes a loop to prevent particles going into the appliance from the sink.

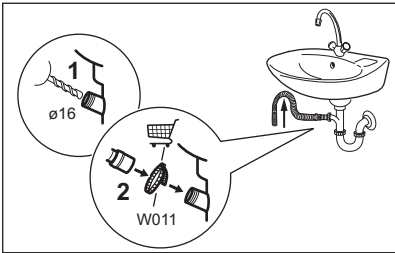

Connect the drain hose to the spigot and tighten it with a clamp. Make sure that the drain hose makes a loop to prevent particles going into the appliance from the sink.

6. Position the hose directly to a built-in drain pipe in the room wall and tighten it with a clamp.

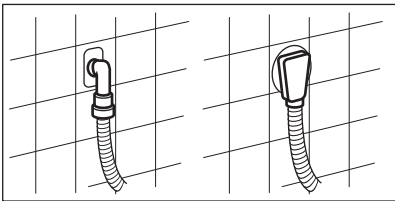

INSTALLATION ON SUSPENDED FLOORING

Suspended wooden floors are particularly susceptible to vibration.

To limit vibration we recommend placing a waterproof wooden panel, at least 15 mm thick, under the appliance. It should be screwed to at least 2 floor beams and should extend beyond the front feet.

If possible, install the appliance where the floor is more stable.

ELECTRICAL CONNECTION

At the end of installation you can connect the mains plug to the mains socket.

The rating plate and the 'Technical Data' chapter indicate the necessary electrical ratings. Make sure that they are compatible with the mains power supply.

Check that your domestic electrical installation can take the maximum load required, also taking into account any other appliances in use.

Connect the appliance to an earthed socket.

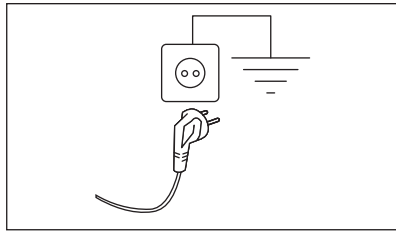

The power supply cable must be easily accessible after installing the appliance.

For any electrical work required to install this appliance, contact our Authorised Service Centre.

The manufacturer does not accept any responsibility for damage or injury through failure to comply with the above safety precaution.

CONTROL PANEL



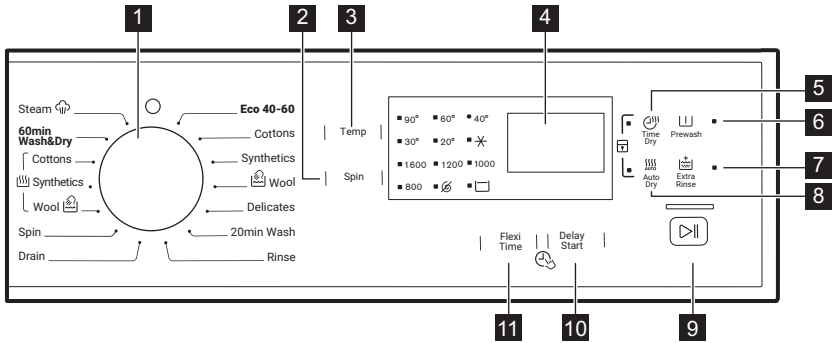



CONTROL PANEL DESCRIPTION

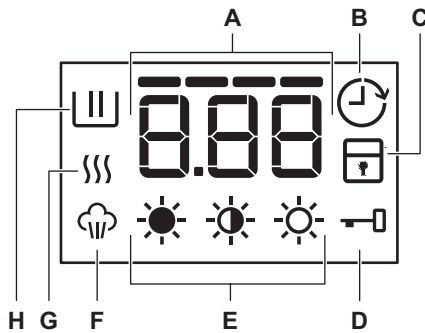

- 1** Programme knob
- 2** Spin speed reduction (Spin)
- 3** Temperature selection (Temp.)
- 4** Display
- 5** Drying time selection (Time Dry)
- 6** Prewash phase (Prewash)
- 7** Additional rinse (Extra Rinse)
- 8** Automatic drying level (Auto Dry)
- 9** Start/Pause
- 10** Delay start setting (Delay Start)
- 11** Time saving (Flex Time)

DISPLAY









A	Time area	1.25: Programme duration
		40: Selected drying time
		2h: Delay start
		E20: Alarm codes
		E r r: Message of error
		0: The programme is completed.
	Time programme indicators	- - - -: Normal duration indicator
		- -: Quick indicator
	- : Super quick indicator	
B		Delay start indicator
C		Child safety lock indicator
D		Door locked indicator
E		Indicators of dryness level
F		Steam indicator
G		Drying phase indicator
H		Washing phase indicator

PROGRAMMES

PROGRAMME CHART

Programme Default temperature Temperature range	Maximum load Reference spin speed	Programme description (Type of load and level of soiling)
Eco 40-60 (Wash only mode) 40 °C ¹⁾ 60 °C ²⁾ - 30 °C	8 kg 1600 rpm	White cotton and fast-coloured cotton. Normally soiled items.
Eco 40-60 + Cupboard dry level (Wash & Dry mode) 40 °C ³⁾ 60 °C - 30 °C	4 kg 1600 rpm	

Programme Default temperature Temperature range	Maximum load Reference spin speed	Programme description (Type of load and level of soiling)
Eco 40-60 + Cupboard dry level (Dry only mode) ⁴⁾	4 kg	White cotton and fast-coloured cotton.
Cottons 40 °C 90°C - ✱ (Cold)	8 kg 1600 rpm	White cotton and coloured cotton. Normally, heavily and lightly soiled items.
Synthetics 40 °C 60°C - ✱ (Cold)	3 kg 1200 rpm	Synthetic items or mixed fabric items. Normally soiled items.
 Wool 40 °C 40°C - ✱ (Cold)	1.5 kg 1200 rpm	Machine washable wool, hand washable wool and other fabrics with «hand washing» care symbol ⁵⁾ .
Delicates 30 °C 40°C - ✱ (Cold)	2 kg 1200 rpm	Delicate fabrics such as acrylics, viscose and mixed fabrics requiring gentler wash- ing. Normally and lightly soiled items.
20min Wash 30 °C 40 °C - 30 °C	3 kg 1200 rpm	A very short cycle for lightly soiled cotton and synthetic items or worn only once.
Rinse	8 kg ⁶⁾ 1600 rpm ⁷⁾	To rinse and spin the laundry. All fabrics , ex- cept woollens and very delicate fabrics. Reduce the spin speed accordingly to the type of laun- dry.
Drain	8 kg	To drain the water in the drum. All fabrics.
Spin	8 kg ⁶⁾ 1600 rpm ⁷⁾	All fabrics, except woollens and delicate fabrics. To spin the laundry and to drain the water in the drum.
 Wool	1 kg	Drying programme for woollens.
 Synthetics	3 kg	Drying programme for synthetic items.
 Cottons	4 kg	Drying programme for cotton items.
60min Wash&Dry 30 °C 40 °C - 30 °C	1 kg 1200 rpm	Complete programme composed of a washing phase and of a drying phase for a small load of mixed fabrics (cotton and synthetic items).

Programme Default temperature Temperature range	Maximum load Reference spin speed	Programme description (Type of load and level of soiling)
 Steam	1 kg	Steam programme can be used for reducing wrinkles and odours ⁸⁾ of garments that just need to be refreshed, avoiding washing. The fabric fibres are relaxed and afterwards ironing becomes effortless. When the programme is completed, quickly remove the laundry from the drum ⁹⁾ . Steam programmes do not perform any hygienic cycle. Do not set this programme with the following type of items: <ul style="list-style-type: none"> ▪ Items that are not suitable for tumble drying. ▪ Items with label "Dry clean only".
	Off position	

1) According to Commission Regulation EU 2019/2023. This programme at default temperature and spin speed, in washing only mode, with rated capacity 8 kg is able to clean normally soiled cotton laundry declared to be washable at 40 °C or 60 °C, together in the same cycle.



For the reached temperature in the laundry, the programme duration and other data, please refer to 'Consumption Values' chapter.

The most efficient programmes in terms of energy consumption are generally those that perform at lower temperatures and longer duration.

2) Cottons energy saving programme. This programme at 60°C with a load of 8 kg is the reference programme for data entered in the energy label, in compliance with 96/60/EC Directive. Set this programme to have a good washing results and decrease the energy consumption. The time of the washing programme is extended.

3) According to Commission Regulation EU 2019/2023. This programme at default temperature and spin speed, in washing and drying mode, with rated capacity 4 kg and with Cupboard dry level performs the wash and dry cycle able to clean normally soiled cotton laundry declared to be washable at 40 °C or 60 °C, together in the same cycle and, after drying phase, the laundry can be immediately stored in a cupboard.

4) This programme is the drying reference programme for data entered in the energy label on compliance with 96/60/EC Directive. The test performance, in accordance with EN 50229, must be carried out with a FIRST drying load of the maximum declared drying capacity (load composition according to EN61121) by setting the AUTOMATIC CUPBOARD DRY for Eco 40-60 programme. The SECOND drying load with the residual load must be tested by setting the AUTOMATIC CUPBOARD DRY for Eco 40-60 programme.

5) During this cycle the drum rotates slowly to ensure a gentle wash. It can seem that the drum doesn't rotate or doesn't rotate properly, but this is normal for this programme.







6) The maximum load refers to cottons items. Reduce the load accordingly in case of other type of laundry.

7) The maximum spin speed is related to cotton items. Set the spin speed. Make sure that it agrees with the laundry.

8) Steam programme doesn't remove particularly intense odour.

9) After the steam treatment the laundry can be humid. Hang items out for a few minutes.

Programme options compatibility

Programme	Spin					Flex Time	Delay Start
Eco 40-60	■	■	■	■	■	■ ¹⁾	■
Cottons	■	■	■	■	■	■	■
Synthetics	■	■	■	■	■	■	■
 Wool	■	■	■				■
Delicates	■	■	■		■	■	■
20min Wash	■	■					■
Rinse	■	■	■		■		■
Drain							■
Spin	■	■					■
 Wool							■
 Synthetics							■
 Cottons							■
60min Wash&Dry							■
 Steam						■	■

1) Only the QUICK option is available.

Suitable detergents for each programme

Programme	Universal powder ¹⁾	Liquid Universal	Liquid for coloureds	Delicates woollens	Special
Eco 40-60	▲	▲	▲	--	--
Cottons	▲	▲	▲	--	--
Synthetics	▲	▲	▲	--	--
Delicates	--	--	--	▲	▲



Programme	Universal powder ¹⁾	Liquid Universal	Liquid for coloureds	Delicates woollens	Special
Wool	--	--	--	▲	▲
20min Wash	--	▲	▲	--	--
60min Wash&Dry	--	▲	▲	--	--

1) At temperature higher than 60 °C the use of powder detergent is recommended.

▲ = Recommended

-- = Not recommended

AUTOMATIC DRYING

Dryness Level	Type of fabric	Load
 Extra Dry For towelling materials	Cottons and Linen (bathrobes, bath towels, etc)	up to 4 kg
 Cupboard Dry For items to be stored	Cottons and Linen (bathrobes, bath towels, etc)	up to 4 kg
	Synthetics and mixed fabrics (jumpers, blouses, underwear, household and bed linen)	up to 3 kg
	Wool items (woollen jumpers)	up to 1 kg
 Iron Dry Suitable for ironing	Cottons and Linen (sheets, tablecloths, shirts, etc)	up to 4 kg

TIMED DRYING

Dryness Level	Type of fabric	Load (kg)	Spin speed (rpm)	Suggested duration (mins)
Extra Dry For towelling materials	Cottons and Linen (bathrobes, bath towels, etc)	4	1600	165 - 180
		2	1600	90 - 100
		1	1600	60 - 70
Cupboard Dry For items to be stored	Cottons and Linen (bathrobes, bath towels, etc)	4	1600	155 - 170
		2	1600	80 - 90
		1	1600	50 - 60

Dryness Level	Type of fabric	Load (kg)	Spin speed (rpm)	Suggested duration (mins)
Cupboard Dry For items to be stored	Synthetics and mixed fabrics (jumpers, blouses, underwear, household and bed linen)	3	1200	90 - 105
		1	1200	40 - 50
	Wool (woollen jumpers)	1	1200	80 - 100
Iron Dry Suitable for ironing	Cottons and Linen (sheets, tablecloths, shirts, etc)	4	1600	110 - 125
		2	1600	65 - 75
		1	1600	40 - 50

OPTIONS

TEMP.

Set this option to change the default temperature.

Indicator  = cold water.

The display shows the set temperature.

SPIN

With this option you can change the default spin speed.

The indicator of the set speed comes on.

Additional spin options:

No Spin

- Set this option to deactivate all spin phases. Only the drain phase is available.
- The related indicator comes on.
- Set this option for very delicate fabrics.
- The rinses phase uses more water for some washing programmes.

Rinse Hold

- Set this option to prevent the laundry creases.
- The related indicator comes on.
- There is a water in the drum when the programme is completed.
- The drum turns regularly to prevent the laundry creases.
- The door stays locked. You must drain the water to unlock the door.



To drain the water refer to 'At the end of the programme'.

TIME DRY



With this option you can set the time for the fabrics you have to dry. The display shows the set value. Each time you press this touchpad the time value increases by 5 minutes.



You cannot set all time values for different types of fabrics.

AUTO DRY

With this option you can set an automatic level of dryness for the laundry. The display shows the symbol of the set level.

-  **Extra dry** level for cotton items
-  **Cupboard dry** level for cotton and synthetic items
-  **Iron dry** level for cotton items

PREWASH

With this option you can add a prewash phase to a washing programme.

Use this option for heavy soil.

When you set this option the programme duration increases.

The related indicator comes on.

EXTRA RINSE

With this option you can add extra rinses to a washing programme.

Use this option for persons allergic to detergents and in areas where the water is soft. The related indicator comes on.

DELAY START

With this option you can delay the start of a programme from 30 minutes to 20 hours. The display shows the related indicator.



FLEX TIME

Press Flex Time to decrease the programme time.



SETTINGS

CHILD LOCK

With this option you can prevent that the children play with the control panel.

- To **activate/deactivate** this option, press  and  at the same time until the indicator  **comes on/goes off**.

You can activate this option:

- After you press : the options and the programme knob are locked.
- Before you press : the appliance cannot start.

PERMANENT EXTRA RINSE

With this option you can permanently have an extra rinse when you set a new programme.

BEFORE FIRST USE



During installation or before first use you may observe some water in the appliance. This is residual water left in the appliance after a full functional test in the factory to ensure the appliance is delivered to customers in perfect working order and is no cause for concern.



1. Connect the mains plug to the mains socket.
2. Open the water tap.

DAILY USE - WASHING ONLY





WARNING! Refer to Safety chapters.

You can select:

-  **QUICK**: to wash items with daily soil.
-  **SUPER QUICK**: to wash quickly items with almost no soil.





Some programmes accept only one of these options.

- To **activate/deactivate** this option press  and  at the same time until the indicator  **comes on/goes off**.

ACOUSTIC SIGNALS

The acoustic signals operate when:

- The programme is completed.
- The appliance has a malfunction.

To **deactivate/activate** the acoustic signals, press  and  at the same time for 6 seconds.



If you deactivate the acoustic signals, they continue operate when the appliance has a malfunction.

3. Put 2 litre of water in the detergent compartment for washing phase.

This activates the drain system.

4. Put a small quantity of detergent in the compartment for washing phase.

5. Set and start a programme for cotton at the highest temperature without laundry.

This removes all possible dirt from the drum and the tub.

LOADING THE LAUNDRY

1. Open the appliance door.
2. Empty the pockets and unfold the items before you put them in the appliance.

- Put the laundry in the drum, one item at a time. Do not put too much laundry in the drum.
- Close the door firmly.

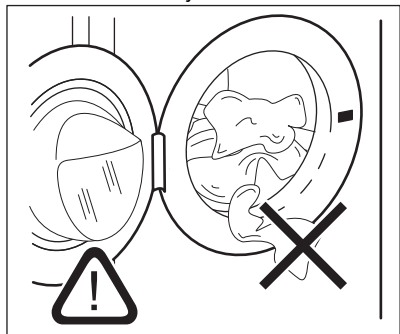

CAUTION! Make sure that no laundry gets caught between the seal and the door to avoid risk of water leakage and damage to the laundry.



Washing heavily oiled, greasy stains could cause damage to rubber parts of the washing machine.

USING DETERGENT AND ADDITIVES

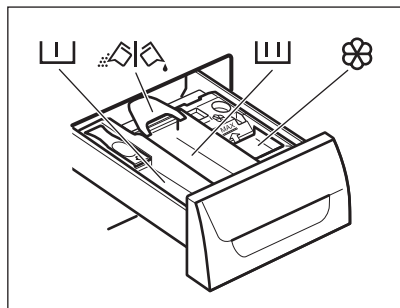

- Measure out the detergent and the fabric conditioner.
- Put the detergent and the fabric conditioner into the compartments.



Always follow the instructions that you find on the packaging of the detergent products, but we recommend that you do not exceed the maximum indicated level. This quantity will however guarantee the best washing results.

- Carefully close the detergent drawer.

CHECK THE POSITION OF THE DETERGENT FLAP

- Pull out the detergent dispenser until it stops.

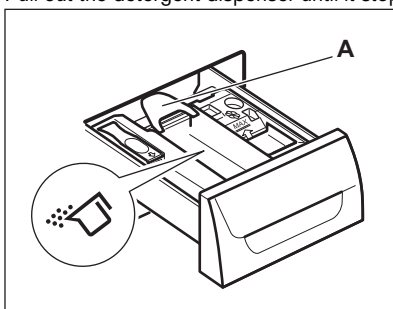

- Press the lever down to remove the dispenser.
- To use powder detergent, turn the flap up.
- To use liquid detergent, turn the flap down.

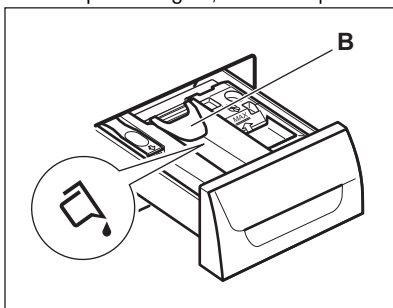

With the flap in the position **DOWN**:

- Do not use gelatinous or thick liquid detergents.
 - Do not exceed to liquid detergent dose indicated on the flap.
 - Do not set the prewash phase.
 - Do not set the delay start function.
- Measure out the detergent and the fabric conditioner.
 - Carefully close the detergent dispenser.

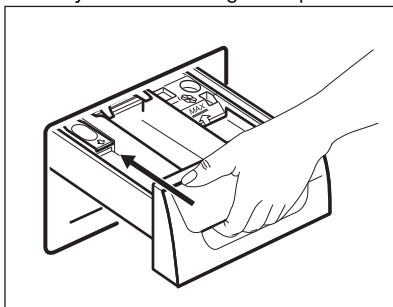

Make sure that the flap does not cause a blockage when you close the drawer.

SETTING A PROGRAMME



1. Turn the programme knob to switch the appliance on and set the required programme:
 - The indicator  flashes.
 - The display shows the level of the Time Manager, the programme duration and the indicators of the phases of the programme.
2. If necessary, change the temperature and the spin speed or add available options. When you activate an option, the indicator of the set option comes on.



If you set something incorrect, the display shows the message .

STARTING A PROGRAMME WITHOUT THE DELAY START

Press .

- The indicator of  stops to flash and stays on.
- The indicator  starts to flash on the display.
- The programme starts, the door locks, the display shows the indicator .
- The drain pump can operate for a short time when the appliance fills water.





After approximately 15 minutes from the start of the programme:

- The appliance adjusts automatically the programme duration agree with the laundry load.
- The display shows the new value.

STARTING A PROGRAMME WITH THE DELAY START

1. Press Delay Start again and again until the display shows the delay you want to set.





The related indicator comes on the display.

2. Press :
 - The appliance starts the countdown.
 - The door locks, the display shows the indicator .
 - When the countdown is completed, the programme starts automatically.



You can cancel or change the set of the delay start before you press the

. To cancel the delay start:

- Press  to set the appliance to pause.
- Press  until the display shows .
- Press  again to start the programme immediately.

INTERRUPTING A PROGRAMME AND CHANGING THE OPTIONS

You can change only some options before they operate.

1. Press .

The indicator flashes.

2. Change the options.

3. Press  again.

The programme continues.

CANCELLING A RUNNING PROGRAMME

1. Turn the programme knob to position  to cancel the programme and to deactivate the appliance.
2. Turn the programme knob again to activate the appliance. Now, you can set a new washing programme.



Before starting the new programme the appliance could drain the water. In this case, make sure that the detergent is still in the detergent compartment, if not fill the detergent again.



OPENING THE DOOR



CAUTION! If the temperature and level of the water in the drum are too high and the drum still rotates, you cannot open the door.





While a programme or the delay start operates, the appliance door is locked and the display shows the indicator .

Open the appliance door when the programme or the delay start operates:



1. Press  to pause the appliance.
2. Wait until the door lock indicator  goes off.
3. Open the door.
4. Close the door and press again .

The programme or delay start continues to operate.



AT THE END OF THE PROGRAMME



- The appliance stops automatically.
- The acoustic signal operates (if it is activated).
- In the display  comes on.
- The indicator of the  goes off.
- The door lock indicator  goes off.
- You can open the door.
- Remove the laundry from the appliance. Make sure that the drum is empty.
- Close the water tap.
- Turn the programme knob to position  to deactivate the appliance.
- Keep the door ajar, to prevent the mildew and odours.

The washing programme is completed, but there is water in the drum:

- The drum turns regularly to prevent the creases in the laundry.
- The door lock indicator  is on. The indicator  flashes. The door stays locked.
- You must drain the water to open the door.

To drain the water:

1. If necessary, decrease the spin speed. If you set , the appliance only drains.
2. Press . The appliance drains the water and spins.

3. When the programme is completed, and the door lock indicator  goes off, you can open the door.
4. Turn the programme knob to position  to deactivate the appliance.



The appliance drains and spins automatically after approximately 18 hours (except for Wool programme).

STAND-BY

Some minutes after the end of the washing programme, if you do not deactivate the appliance, the energy saving status activates.

The energy saving status decreases the energy consumption when the appliance is on the stand by.

- All indicators and the display go off.
- The indicator of the  flashes slowly
- Press one of the options to deactivate the energy saving status.



If you set a programme or an option that ends with water in the drum, the energy saving status function **doesn't activate** to remind you to drain the water.

DAILY USE - DRYING ONLY



WARNING! Refer to Safety chapters.



This appliance is an automatic washer dryer.

DRYING SETTING



WARNING! Make sure that the water tap is open.





1. Turn the programme knob to the desired programme to activate the appliance.
2. Load the laundry one item at a time.
3. Turn the programme dial to the programme applicable for the items to dry. The display shows the drying indicator .



To have a good drying performance **do not** exceed the maximum drying loads recommended in the user manual. **Do not** set a spin speed lower than the automatic speed of the set programme.

DRYING AT AUTOMATIC LEVELS

The laundry can be dried at pre-defined levels of dryness:

1. Press  again and again until the display shows one of the dryness level indicator:
 - : IRON DRY level indicator for cotton items
 - : CUPBOARD DRY level indicator for cotton and synthetic items
 - : EXTRA DRY level indicator for cotton items

The display shows a time value, calculated on the default load size. If the amount of your laundry is

more or less than the default size, the appliance adjusts automatically the time value during the cycle.

2. Press  to start the programme.

The display shows the door locked indicator .

The drying indicator  starts to flash.

 You cannot set all dryness levels for any type of laundry.

TIMED DRYING

The laundry can also be dried with a manual timed drying:

1. Press  again and again to set the time value (see the «Programmes for timed drying» table).

- The display shows 10 minutes. Each time you press this touchpad the time value increases by 5 minutes.
- The display shows the set time value: for example – 40.
- After some seconds the display shows a new time value: 43. The appliance calculates also the duration of the anti-crease and the cooling phases.

2. Press  to start the programme.



- The display shows regularly a new time value.
- The drying indicator  starts to flash.

- The display shows the door locked indicator .

 If you set only 10 minutes of drying, the appliance performs only a cooling phase.
If the laundry is not sufficient dry, set again a short drying time.

END OF THE DRYING PROGRAMME

The appliance stops automatically.

- The acoustic signals operate (if they are active).
- In the display  comes on.
- The indicator  goes off.
- The last minutes of the drying cycle the appliance performs a cooling and anti-crease phase. The door is still locked.

When the door locked  goes off in the display, you can open the door.

1. Turn the programme knob to  to deactivate the appliance.

After some minutes from the end of the programme, the energy saving function automatically deactivates the appliance.

2. Remove the laundry from the appliance.

Make sure that the drum is empty.

3. Keep the door ajar, to prevent mildew and odours.

4. Close the water tap.

DAILY USE - WASHING & DRYING



WARNING! Refer to Safety chapters.



This appliance is an automatic washer dryer.

NON-STOP PROGRAMME

1. Turn the programme knob to the desired programme to activate the appliance.
2. Load the laundry one item at a time.



To have a good drying performance **do not** exceed the maximum drying loads recommended in the user manual. **Do not** set a spin speed lower than the automatic speed of the set programme.





3. Put the detergent and the additives in the appropriate compartment.

4. Turn the programme dial to the washing programme.

The display shows the indicators of the different washing phases.

5. Set the available options.

WASHING & AUTOMATIC DRYING

1. Press  again and again until the display shows one of the dryness level indicator:
 - : IRON DRY level indicator for cotton items
 - : CUPBOARD DRY level indicator for cotton and synthetic items
 - : EXTRA DRY level indicator for cotton items

The display shows the indicator . The time value on the display is the duration of the washing + drying cycles, calculated on a default load size.



To have a good drying the appliance does not let you set a too low spin speed for the items to be washed and dried.

2. Press to start the programme.

In the display the indicator of the set dryness level stays on.

The door locked indicator goes on.

The display shows regularly a new time value.



The last minutes of the drying cycle the appliance performs the anti-crease and the cooling phases.

WASHING & TIMED DRYING

To have a good drying the appliance does not let you set a too low spin speed for the items to be washed and dried.

1. Press to set the drying time value. The display shows 10 minutes.

The indicator comes on in the display. The display shows the set drying value time. for

example: . After some seconds the display

FLUFF IN THE FABRICS

During the washing and/or drying phase, some types of fabric, (sponge, wool, sweatshirt) could release fluff.

The released fluff could stick to the fabrics during the next cycle.

To prevent the fluff in your laundry, we recommend that you:

- Do not wash dark fabrics after you have washed and dried light coloured fabrics (new sponge, wool, sweatshirt) and the contrary.
- Line dry this type of fabrics at open air when they are washed the first time.
- Clean the drain filter.
- After the drying phase, clean the empty drum, the gasket and the door with a wet cloth.

HINTS AND TIPS



WARNING! Refer to Safety chapters.

THE LAUNDRY LOAD

- Divide the laundry in: white, coloured, synthetics, delicates and wool.

shows the final time value **2:03**, that is the total duration of the washing and drying cycles (washing + drying + anti-crease + cooling phases).



If you set only 10 minutes of drying after washing, the appliance calculates also the duration of the anti-crease and the cooling phases.

2. Press to start the programme.

In the display the indicator comes on. The door is locked. The display shows regularly a new time value.

END OF THE PROGRAMME

The appliance stops automatically. The acoustic signals operate (if they are active).

For more information see "At the end of the drying programme " of the previous chapter.

1. Remove the laundry from the appliance.

Make sure that the drum is empty.

2. Keep the door ajar to prevent mildew and odours.
3. Close the water tap.

HOW TO REMOVE THE FLUFF IN THE GARMENTS

To remove the fluff inside the drum, set a special programme:

1. Empty the drum.
2. Clean the drum, the gasket and the door with a wet cloth.
3. Set the rinse programme.
4. Press at the same time and to activate the cleaning function until the display shows **CLE**.
5. Press to start the programme.

- Obey the washing instructions that are on the laundry care labels.
- Do not wash white and coloured items together.
- Some coloured items can discolour with the first wash. We recommend that you wash them separately for the first times.
- Turn multilayered fabrics, wool and items with painted illustrations inside out.

- Wash and pre-treat heavy soil stains with a suitable detergent before putting in drum.
- Be careful with the curtains. Remove the hooks and put the curtains in a washing bag or pillowcase.
- Do not wash laundry without hems or with cuts. Use a washing bag to wash small and/or delicate items (e.g. underwired bras, belts, tights, shoelaces, ribbons, etc.).

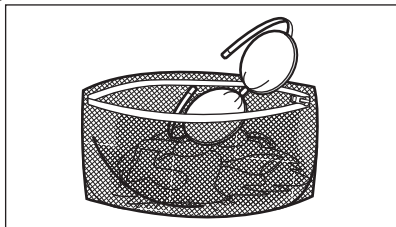

- A very small load can cause balance problems with the spin phase leading to excessive vibration. If this occurs:
 - interrupt the programme and open the door (refer to "Daily Use" chapter);
 - manually redistribute the load so that the items are spaced evenly around the tub;
 - press the Start/Pause button. The spin phase continues.
- Button up pillowcases, close zippers, hooks and poppers. Tie up belts, cords, shoelaces, ribbons and any other loose elements.
- Empty the pockets and unfold the items.

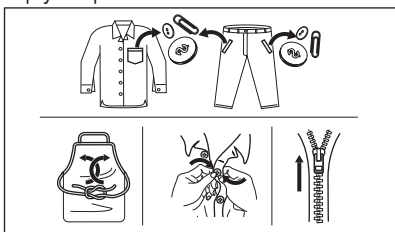

STUBBORN STAINS

For some stains, water and detergent is not sufficient.

We recommend that you pre-treat these stains before you put the items in the appliance.

Special stain removers are available. Use the special stain remover that is applicable to the type of stain and fabric.

Do not spray stain remover on garments near the appliance as it is corrosive to the plastic parts.



DETERGENT TYPE AND QUANTITY.

The choice of detergent and use of correct quantities not only affects your wash performance, but also helps to avoid waste and protect the environment:

- Use only detergents and other treatments specially made for washing machines. First, follow these generic rules:
 - powder detergents for all types of fabric, excluding delicate. Prefer powder detergents containing bleach for whites and laundry sanitization,
 - liquid detergents, preferably for low temperature wash programmes (60 °C max) for all types of fabric, or special ones for woollens only.
- The choice and quantity of detergent will depend on: type of fabric (delicates, woollens, cottons, etc), the colour of clothes, size of the load, degree of soiling, wash temperature and hardness of the water used.
- Follow the instructions that you find on packaging of the detergents or other treatments without exceeding the indicated maximum level (**MAX**).
- Do not mix different types of detergents.
- Use less detergent if:
 - you are washing a small load,
 - the laundry is lightly soiled,
 - there is large amounts of foam during washing.
- When using detergent tabs or pods, always put them inside the drum, not in the detergent dispenser.

Insufficient detergent may cause:

- unsatisfactory washing results,
- the wash load to turn grey,
- greasy clothes,
- mould in the appliance.

Excessive detergent may cause:

- sudsing,
- reduced washing effect,
- inadequate rinsing,
- a greater impact for the environment.

ECOLOGICAL HINTS

To save water, energy and to help protect the environment, we recommend that you follow these tips:

- **Normally soiled laundry** may be washed **without prewash** in order to save detergent, water and time (the environment is protected too!).
- Loading the appliance to the **maximum capacity indicated for each programmes helps to reduce energy and water consumption.**
- With adequate pre-treatment, stains and limited soiling can be removed; the laundry can then be washed at a lower temperature.
- To use the correct quantity of detergent, refer to the quantity suggested by the detergent producer and check the water hardness of your domestic system. Refer to "Water hardness".

WATER HARDNESS

If the water hardness in your area is high or moderate, we recommend that you use a water softener for washing machines. In areas where the water hardness is soft it is not necessary to use a water softener.

To know the water hardness in your area, contact your local water authority.

Use the correct quantity of the water softener.

Obey the instructions that you find on the packaging of the product.

PREPARE THE DRYING CYCLE

- Open the water tap.
- Check if the drain hose is connected properly. Refer to installation chapter for more information.
- For the maximum laundry load of the drying programmes, refer to the drying programmes table.

ITEMS NOT SUITABLE FOR DRYING

Do not set a drying programme for this laundry:

- Synthetic curtains.
- Pieces of clothing with metal inserts.
- Nylon stockings.
- Quilts.

CARE AND CLEANING







WARNING! Refer to Safety chapters.

- Bed covers.
- Duvets.
- Anoraks.
- Sleeping bags.
- Fabrics with residue of hair sprays, nail solvents or similar.
- Garments with foam-rubber or materials similar to foam-rubber.

GARMENT LABELS

When you dry the laundry, obey the indications on the labels of the manufacturers:

-  = The item can be tumble dried
-  = The drying cycle is at high temperature
-  = The drying cycle is at reduced temperature
-  = The item can not be tumble dried.

DRYING CYCLE DURATION

The drying time can change depending on:

- speed of the last spin
- dryness level
- type of laundry
- weight of the load

ADDITIONAL DRYING

If, at the end of the drying programme, the laundry is still damp, set a short drying cycle again.



WARNING! To avoid creasing and shrinkage do not overdry the laundry.

GENERAL TIPS

Refer to the «Drying programmes» table to find the **average** drying times.

Experience will help you to dry the laundry better. Take note of the duration of the cycles done before.

To avoid the static charge at the end of the drying cycle:

1. Use fabric conditioner in the washing cycle.
2. Use special fabric conditioner for tumble dryers.

When the drying programme is completed remove the laundry promptly.

PERIODIC CLEANING SCHEDULE

Periodic cleaning helps to extend the life of your appliance.

After each cycle, keep the door and the detergent dispenser slightly ajar to get air circulation and dry the humidity inside the appliance: this will prevent mildew and odours.

If the appliance is not used for a long time: close the water tap and unplug the appliance.

Indicative periodic cleaning schedule:

Descaling	Twice a year
Maintenance wash	Once a month
Clean door seal	Every two months
Clean drum	Every two months
Remove fluff inside the drum	Twice a month ¹⁾
Clean detergent dispenser	Every two months
Clean drain pump filter	Twice a year
Clean the inlet hose and the valve filter	Twice a year

1) Refer to "Fluff in the fabrics" chapter.

The following paragraphs explain how you should clean each part.

REMOVING FOREIGN OBJECTS



Make sure that pockets are empty and all loose elements are tied up before running your cycle. Refer to 'The laundry load' in 'Hints and tips'.

Remove any foreign objects (such as metal clip, buttons, coins, etc) that you may find in the door seal, the filters and the drum. Refer to 'Door seal with double lip trap', 'Cleaning the drum', 'Cleaning the drain pump' and 'Cleaning the inlet hose and the valve filter' paragraphs. If necessary, please contact the Authorised Service Centre.

EXTERNAL CLEANING

Clean the appliance with soap and warm water only. Fully dry all the surfaces. Do not use a scouring pads or any scratching material.



CAUTION! Do not use alcohol, solvents or chemical products.



CAUTION! Do not use the metal surfaces with chlorine-based detergent.

DESCALING

If the water hardness in your area is high or moderate, we recommend that you use a water descaling product for washing machines.

Regularly examine the drum to prevent limescale and rust particles.

To remove rust particles use only special products for washing machines. Do this separately from the laundry wash.



Always obey the instructions that you find on the packaging of the product.

MAINTENANCE WASH

With the low temperature programmes it is possible that some detergent stays in the drum. Perform a maintenance wash regularly. To do this:

- Remove all laundry from the drum.
- Select the cotton programme with the highest temperature with a small quantity of detergent.

DOOR SEAL WITH DOUBLE LIP TRAP

This appliance is designed with a **self cleaning draining system**, allowing light fluff fibers that fall off the clothes to be drained out with the water. Regularly examine the seal. Coins, buttons, other small items can be recovered at the end of the cycle.

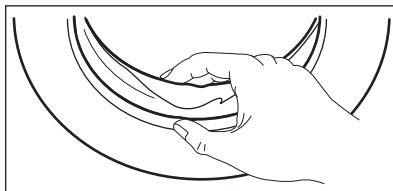

Clean it when needed, using ammonia cream cleanser agent without scratching the seal surface.



Always obey the instructions that you find on the packaging of the product.

CLEANING THE DETERGENT DISPENSER

1.

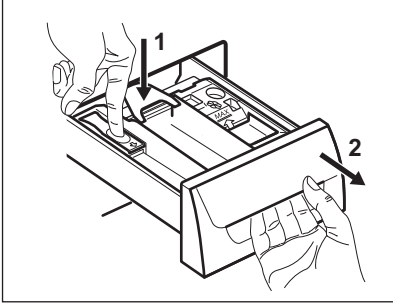

2.

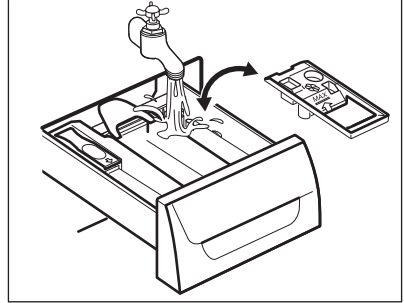

3.

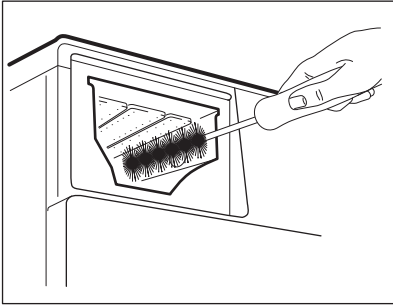

4.

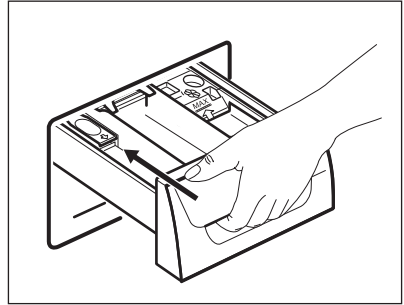

CLEANING THE DRAIN FILTER



Do not clean the drain filter if the water in the appliance is hot.

- Repeat the steps 2 and 3 until the water stops flowing out.
- Always keep a rag nearby to dry up any water spillage.

1.

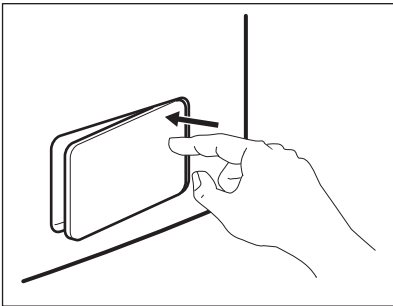

2.

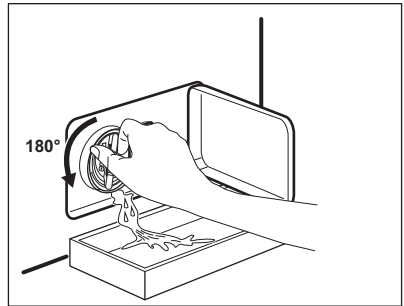

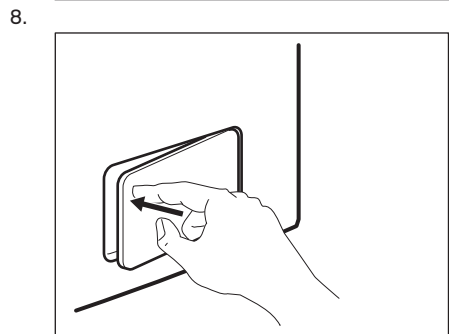
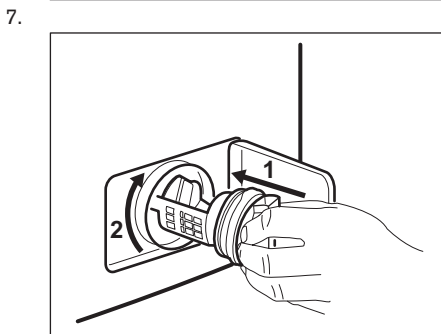
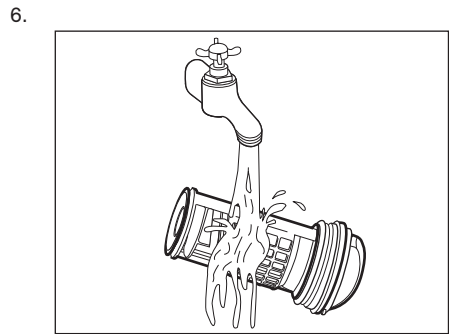
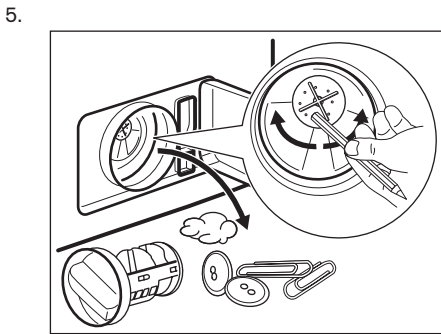
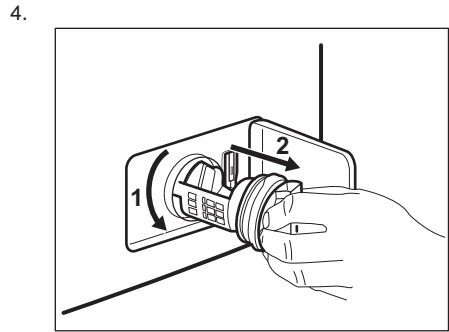
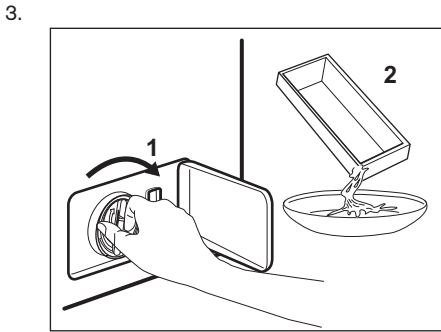

Regularly check the drain pump filter and make sure that it is clean.



Make sure that the impeller of the pump can rotate. If it does not rotate, contact the Authorised Service Centre. Make sure also that you tighten the filter correctly to prevent leakages.

CLEANING THE INLET HOSE AND THE VALVE FILTER

1.

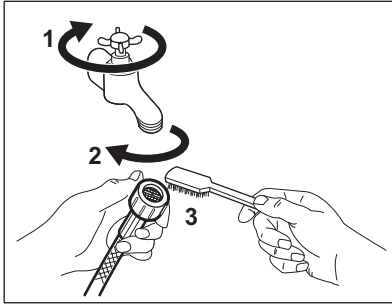

2.

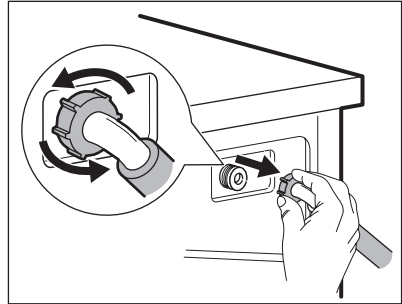

3.

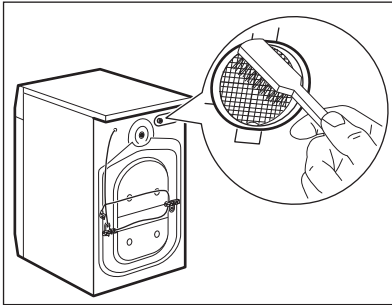

4.

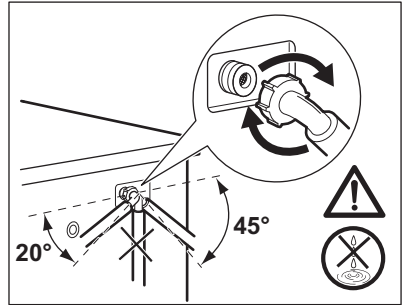

EMERGENCY DRAIN

Because of a malfunction, the appliance cannot drain the water.

If this occurs, do steps (1) through (8) of 'Cleaning the drain filter'. If necessary, clean the pump.

When you drain the water with the emergency drain procedure, you must activate the drain system again:

1. Put 2 litres of water in the main wash compartment of the detergent dispenser.
2. Start the programme to drain the water.

FROST PRECAUTIONS

If the appliance is installed in an area where the temperature can be less than 0° C, remove the remaining water from the inlet hose and the drain pump.

1. Disconnect the mains plug from the mains socket.
2. Close the water tap.
3. Put the two ends of the inlet hose in a container and let the water flow out of the hose.
4. Empty the drain pump. Refer to the emergency drain procedure.
5. When the drain pump is empty, install the inlet hose again.



WARNING! Make sure that the temperature is higher than 0 °C before you use the appliance again. The manufacturer is not responsible for damages caused by low temperatures.

TROUBLESHOOTING



WARNING! Refer to Safety chapters.

ALARM CODES AND POSSIBLE FAILURES

The appliance does not start or it stops during operation. First try to find a solution to the problem (refer to the tables).



WARNING! Deactivate the appliance before carrying out any check.

With some problems, the display shows an alarm code and the Start/

Pause  **button may flash continuously:**

Problem	Possible solution
<p>E 10 The appliance does not fill with water properly.</p>	<ul style="list-style-type: none"> ▪ Make sure that the water tap is open. ▪ Make sure that the pressure of the water supply is not too low. For this information, contact your local water authority. ▪ Make sure that the water tap is not clogged. ▪ Make sure that the inlet hose has no kinks, damages or bends. ▪ Make sure that the connection of the water inlet hose is correct. ▪ Make sure that the filter of the inlet hose and the filter of the valve are not clogged. Refer to 'Care and cleaning'.
<p>E20 The appliance does not drain the water.</p>	<ul style="list-style-type: none"> ▪ Make sure that the sink spigot is not clogged. ▪ Make sure that the drain hose has no kinks or bends. ▪ Make sure that the drain filter is not clogged. Clean the filter, if necessary. Refer to "Care and cleaning". ▪ Make sure that the connection of the drain hose is correct. ▪ Set the drain programme if you set an option which ends with water in the tub.
<p>E40 The appliance door is open or not closed correctly.</p>	<ul style="list-style-type: none"> ▪ Make sure that the door is properly closed.
<p>E91 Internal fail. No communication between electronic elements of the appliance.</p>	<ul style="list-style-type: none"> ▪ The programme was not finished properly or the appliance stopped too early. Switch the appliance off and on again. ▪ If the alarm code appears again, contact the Authorised Service Centre.
<p>E40 The mains supply is unstable.</p>	<ul style="list-style-type: none"> ▪ Wait until mains supply is stable.

If the display shows other alarm codes, deactivate and activate the appliance. If the problem continues, contact the Authorised Service Centre.

In case of different problem with the washing machine check the table below for possible solutions.

Problem	Possible solution
The programme does not start.	<ul style="list-style-type: none"> ▪ Make sure that the mains plug is connected to the mains socket. ▪ Make sure that the appliance door is closed. ▪ Make sure that there is no damaged fuse in the fuse box. ▪ Make sure that the Start/Pause  has been touched. ▪ If the delay start is set, cancel the setting or wait for the end of count-down. ▪ Deactivate the Child Lock function if it is on. ▪ Check the position of the knob on the selected programme.
The appliance fills with water and drains immediately.	<ul style="list-style-type: none"> ▪ Make sure that the drain hose is in the correct position. The hose may be positioned too low. Refer to "Installation instruction".
The spin phase does not operate or the washing cycle lasts longer than usual.	<ul style="list-style-type: none"> ▪ Make sure that the drain filter is not clogged. Clean the filter, if necessary. Refer to "Care and cleaning". ▪ Adjust manually the items in the tub and start the spin phase again. This problem may be caused by balance problems.
There is water on the floor.	<ul style="list-style-type: none"> ▪ Make sure that the couplings of the water hoses are tight and there is not water leakages. ▪ Make sure that the water inlet hose and the drain hose have no damages. ▪ Make sure you use the correct detergent and the correct quantity of it.
You cannot open the appliance door.	<ul style="list-style-type: none"> ▪ Make sure that a washing programme that ends with water in tub, has not been selected. ▪ Make sure that the washing programme is finished. ▪ Make sure that the appliance receives electrical power. ▪ This problem may be caused by a failure of the appliance. Contact the Authorised Service Centre. If you need to open the door, please read carefully "Emergency door opening".
The appliance makes an unusual noise and vibrates.	<ul style="list-style-type: none"> ▪ Make sure the levelling of the appliance is correct. Refer to "Installation instruction". ▪ Make sure that the packaging and/or the transit bolts are removed. Refer to "Installation instruction". ▪ Add more laundry in the drum. The load may be too small.
The programme duration increases or decreases during programme execution.	<ul style="list-style-type: none"> ▪ The TimeCare System is able to adjust the programme duration according to the type and the laundry load size. Refer to "The TimeCare System load detection" in "Daily Use" chapter.
The washing results are not satisfactory.	<ul style="list-style-type: none"> ▪ Increase the detergent quantity or use a different detergent. ▪ Use special products to remove the stubborn stains before you wash the laundry. ▪ Make sure that you set the correct temperature. ▪ Decrease the laundry load.
Too much foam in the drum during the washing cycle.	<ul style="list-style-type: none"> ▪ Reduce the quantity of detergent.

Problem	Possible solution
After the washing cycle, there are some detergent residues in the dispenser drawer.	<ul style="list-style-type: none"> ▪ Make sure that the flap is in the correct position (UP for powder detergent - DOWN for liquid detergent). ▪ Make sure you have used the detergent dispenser according the indications given in this user manual.
The appliance does not dry or does not dry correctly.	<ul style="list-style-type: none"> ▪ Turn the water tap on. ▪ Make sure the drain filter is not clogged. ▪ Reduce the laundry load. ▪ Make sure you have set the correct cycle. if necessary, set again a short drying time.
The laundry is full of different colours fluff.	<p>The fabrics washed in the previous cycle released fluff of a different colour:</p> <ul style="list-style-type: none"> ▪ The drying phase helps to eliminate some fluff. ▪ Clean the clothes with a fluff remover. <p>In case of an excessive amount of fluff in the drum run the special programme to clean it (refer to "Fluff in the fabrics" for more details).</p>

After the check, activate the appliance. The programme continues from the point of interruption.

If the problem occurs again, contact the Authorised Service Centre.

The necessary data for the service centre are on the rating plate.

EMERGENCY DOOR OPENING

In case of power failure or appliance failure the appliance door remains locked. The washing programme continues, when the power is restored. If the door remains locked in case of failure, it is possible to open it using the emergency unlock feature.

Before opening the door:



CAUTION! Make sure that the water temperature and the laundry are not hot. Wait till they cool down, if necessary.



CAUTION! Make sure that the drum is not rotating. Wait till the drum stops rotating, if necessary.



Make sure that the water level inside the drum is not too high. Proceed with an emergency drain, if necessary (refer to «Emergency drain» in «Care and cleaning» chapter).

To open the door, proceed as follows:

1. Turn the selector to  position to switch the appliance off.
2. Disconnect the mains plug from the mains socket.
3. Open the filter flap.
4. Keep the emergency unlock trigger pulled downward and, at the same time, open the appliance door.

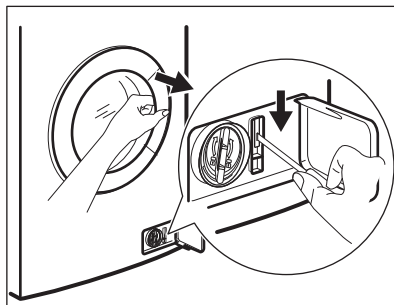

5. Take out the laundry and then close the appliance door.
6. Close the filter flap.

CONSUMPTION VALUES

INTRODUCTION



This user manual reports two different tables in order to favour a gradual passage from a regulation to the other:

- Directive 96/60/EC, valid up to 28th of February 2021, is related to an energy label reporting the Energy Efficiency classes from **A** to **G** for washing and drying cycles.
- Regulation EU 2019/2023, valid from 1st March 2021, is related to an energy label reporting the Energy Efficiency classes, as double scale from **A** to **G**, for the wash and dry complete cycle and for washing cycle only, as set by Regulation EU 2019/2014.



See the web link www.theenergylabel.eu for detailed information about Energy Label.



The QR code on the energy label supplied with the appliance provides a web link to the information related to the performance of the appliance in the EU EPREL database. Keep the energy label for reference together with the user manual and all other documents provided with this appliance.

It is also possible to find the same information in EPREL using the link <https://eprel.ec.europa.eu> and the model name and product number that you find on the rating plate of the appliance. Refer to 'Product description' chapter for the position of the rating plate.

LEGEND

kg	Laundry load.	h:mm	Programme duration.
kWh	Energy consumption.	°C	Temperature in the laundry.
Litres	Water consumption.	rpm	Spin speed.
%	Remaining moisture at the end of the cycle. The higher is the spin speed, the higher is the noise and the lower is the remaining moisture at the end of washing cycle.		



Values and programme duration may differ depending on different conditions (e.g. room temperature, water temperature and pressure, load size and type of laundry, supply voltage) and also if you change the default setting of a programme.

**ACCORDING TO COMMISSION
REGULATION EU 2019/2023**

Washing only

Eco 40-60 programme	kg	kWh	Litres	h:mm	%	°C	rpm¹⁾
Full load	8	1.180	60	3:30	50	46	1551
Half load	4	0.780	45	2:40	50	40	1551
Quarter load	2	0.475	35	2:40	54	33	1551

1) Maximum spin speed.

Wash and dry cycle

Eco 40-60 programme and Cup-board dry level	kg	kWh	Litres	h:mm	%	°C	rpm¹⁾
Full load	4	3.215	68	6:15	0	41	1551
Half load	2	1.825	48	4:35	0	37	1551

1) Maximum spin speed.

ACCORDING TO 96/60/EC DIRECTIVE

Cottons energy saving programme	Load (kg)	Energy consumption (kWh)	Water consumption (litres)	Approximate programme duration (minutes)
Eco 40-60 at 60 °C	8	1.08	63	241

COMMON PROGRAMMES - WASHING ONLY



These values are indicative only.

Programme	kg	kWh	Litres	h:mm	%	°C	rpm¹⁾
Cottons ²⁾ 90°C	8	2.15	90	3:25	44	85	1600

Programme	kg	kWh	Litres	h:mm	%	°C	rpm ¹⁾
Cottons 60°C	8	1.25	85	3:00	44	55	1600
Cottons ³⁾ 20°C	8	0.35	85	2:45	44	20	1600
Synthetics 40°C	3	0.65	50	1:45	35	40	1200
Delicates ⁴⁾ 30°C	2	0.30	40	1:25	35	30	1200
Wool 30°C	1.5	0.25	60	1:05	30	30	1200

- 1) Reference indicator of the spin speed.
2) Suitable for washing heavily soiled textiles.
3) Suitable for washing lightly soiled cottons.
4) It also performs as quick washing cycle for lightly soiled laundry.

COMMON PROGRAMMES - WASH AND DRY



These values are indicative only.

Programme	kg	kWh	Litres	h:mm	%	°C	rpm ¹⁾
Synthetics 40°C	3	2.00	75	4:00	1	40	1200

- 1) Reference indicator of the spin speed.

ENVIRONMENTAL CONCERNS

Recycle materials with the symbol . Put the packaging in relevant containers to recycle it. Help protect the environment and human health by recycling waste of electrical and electronic appliances. Do not dispose of appliances marked

with the symbol with the household waste. Return the product to your local recycling facility or contact your municipal office.

WWW.ZANUSSI.COM/SHOP



CE

157033720-A-392020