

GETTING STARTED? EASY.



ZOHEE2X1
ZOHIE2X1

NL	Gebruiksaanwijzing Oven	2
EN	User Manual Oven	26
FR	Notice d'utilisation Four	48
DE	Benutzerinformation Backofen	72
PT	Manual de instruções Forno	96
ES	Manual de instrucciones Horno	120

ZANUSSI

GA NAAR ONZE WEBSITE VOOR:



Advies over gebruik, brochures, het oplossen van problemen, service- en reparatie-informatie:

www.zanussi.com/support

Wijzigingen voorbehouden.

INHOUDSOPGAVE

1. VEILIGHEIDSINFORMATIE.....	2
2. VEILIGHEIDSVOORSCHRIFTEN.....	4
3. MONTAGE	7
4. BESCHRIJVING VAN HET PRODUCT.....	8
5. BEDIENINGSPANEEL.....	8
6. VOOR HET EERSTE GEBRUIK.....	9
7. DAGELIJKS GEBRUIK.....	9
8. KLOKFUNCTIES.....	10
9. GEBRUIK VAN DE ACCESSOIRES.....	12
10. EXTRA FUNCTIES.....	13
11. AANWIJZINGEN EN TIPS.....	13
12. ONDERHOUD EN REINIGING.....	20
13. PROBLEEMOPLOSSING.....	23
14. ENERGIEZUINIGHEID.....	23

1. ⚠ VEILIGHEIDSINFORMATIE

Lees zorgvuldig de meegeleverde instructies voor installatie en gebruik van het apparaat. De fabrikant is niet verantwoordelijk voor verwondingen of schade die voortvloeit uit de onjuiste installatie of het onjuiste gebruik. Bewaar de instructies altijd op een veilige, toegankelijke plek voor toekomstig gebruik.

1.1 De veiligheid van kinderen en kwetsbare personen

- Dit apparaat kan worden gebruikt door kinderen van 8 jaar en ouder en door mensen met beperkte lichamelijke, zintuiglijke of verstandelijke vermogens of een gebrek aan ervaring en kennis, indien zij onder toezicht staan of instructies hebben gekregen over het veilig gebruiken van het apparaat en indien zij de eventuele gevaren begrijpen. Kinderen jonger dan 8 jaar oud en personen met zware en

complexe beperkingen dienen altijd uit de buurt van het apparaat te worden gehouden, tenzij ze voortdurend onder toezicht staan.

- Laat kinderen niet spelen met het apparaat.
- Houd alle verpakkingen uit de buurt van kinderen en verwijder ze op gepaste wijze.
- **WAARSCHUWING:** Houd kinderen en huisdieren uit de buurt van het apparaat als het in werking is of afkoelt. Makkelijk toegankelijke onderdelen worden heet tijdens gebruik.
- Als het apparaat is voorzien van een kinderslot, dient dit te worden geactiveerd.
- Kinderen mogen zonder toezicht geen reinigings- en onderhoudswerkzaamheden aan het apparaat uitvoeren.

1.2 Algemene veiligheid

- Alleen een erkende installatietechnicus mag het apparaat en de kabel vervangen.
- **WAARSCHUWING:** Het apparaat en de toegankelijke onderdelen ervan worden heet tijdens gebruik. U dient te voorkomen de verwarmingselementen aan te raken.
- Gebruik altijd ovenhandschoenen om accessoires of kookgerei te plaatsen of verwijderen.
- Voordat u welke onderhoudshandeling dan ook verricht, dient u de stekker van het apparaat uit het stopcontact te trekken.
- **WAARSCHUWING:** Zorg ervoor dat het apparaat is uitgeschakeld voordat u de lamp vervangt om elektrische schokken te voorkomen.
- Gebruik het apparaat niet voordat u het in de ingebouwde structuur installeert.
- Gebruik geen stoomreiniger om het apparaat schoon te maken.
- Gebruik nooit agressieve reinigingsmiddelen of scherpe metalen schrapers om de glazen deur schoon te maken, deze kunnen krassen veroorzaken op het oppervlak, waardoor het glas zou kunnen breken.

- Als het netsnoer beschadigd is, moet de fabrikant, een erkende serviceverlener of een gekwalificeerd persoon deze vervangen teneinde gevaarlijke situaties te voorkomen.
- Om de inschuifrails te verwijderen trekt u eerst de voorkant van de inschuifrail en dan de achterkant uit de zijwanden. Installeer de inschuifrails in de omgekeerde volgorde.

2. VEILIGHEIDSVOORSCHRIFTEN

2.1 Installatie



WAARSCHUWING!

Alleen een erkende installatietechnicus mag het apparaat installeren.

- Verwijder alle verpakkingsmaterialen.
- Installeer en gebruik geen beschadigd apparaat.
- Volg de installatie-instructies die zijn meegeleverd met het apparaat.
- Pas altijd op bij verplaatsing van het apparaat, want het is zwaar. Gebruik altijd veiligheidshandschoenen en gesloten schoeisel.
- Trek het apparaat nooit aan de handgreep van zijn plaats.
- Installeer het apparaat op een veilige en geschikte plaats die aan alle installatie-eisen voldoet.
- Houd de minimumafstand naar andere apparaten en units in acht.
- Controleer voordat u het apparaat monteert of de ovendeur onbelemmerd opent.
- Het apparaat is uitgerust met een elektrisch koelsysteem. Het heeft elektrische stroom nodig.

Minimumhoogte kast (Minimumhoogte kast onder werkblad)	590 (600) mm
--	--------------

Kastbreedte	560 mm
-------------	--------

Kastdiepte	550 (550) mm
------------	--------------

Hoogte van de voorkant van het apparaat	598 mm
---	--------

Hoogte van de achterkant van het apparaat	579 mm
---	--------

Breedte van de voorkant van het apparaat	594 mm
Breedte van de achterkant van het apparaat	558 mm
Diepte van het apparaat	561 mm
Ingebouwde diepte van het apparaat	540 mm
Diepte met open deur	1007 mm
Minimumgrootte ventilatie-opening. Opening geplaatst aan de onderkant van de achterzijde	560x20 mm
Lengte netvoedingskabel. Kabel wordt in de rechterhoek van de achterzijde geplaatst	1100 mm
Bevestigingsschroeven	4x25 mm

2.2 Elektrische aansluiting



WAARSCHUWING!

Gevaar voor brand en elektrische schokken.

- Alle elektrische aansluitingen moeten door een gediplomeerd elektromonteur worden gemaakt.
- Dit apparaat moet worden aangesloten op een geaard stopcontact.
- Zorg ervoor dat de parameters op het vermogensplaatje overeenkomen met elektrische vermogen van de netstroom.
- Gebruik altijd een juist geïnstalleerd schokbestendig stopcontact.
- Gebruik geen adapters met meerdere stekkers en verlengkabels.
- Zorg dat u de netstekker en het netsnoer niet beschadigt. Indien de voedingskabel

moet worden vervangen, dan moet dit gebeuren door onze Klantenservice.

- Laat de stroomkabel niet in aanraking komen met de deur van het apparaat of de niche onder het apparaat, met name niet als deze werkt of als de deur heet is.
- De schokbescherming van delen onder stroom en geïsoleerde delen moet op zo'n manier worden bevestigd dat het niet zonder gereedschap kan worden verplaatst.
- Steek de stekker pas in het stopcontact als de installatie is voltooid. Zorg ervoor dat het netsnoer na installatie bereikbaar is.
- Als het stopcontact los zit, mag u de stekker niet in het stopcontact steken.
- Trek niet aan het netsnoer om het apparaat los te koppelen. Trek altijd aan de stekker.
- Gebruik enkel correcte isolatievoorzieningen: stroomonderbrekers, zekeringen (schroefzekeringen moeten uit de houder worden verwijderd), aardlekschakelaars en contactgevers.
- De elektrische installatie moet een isolatieapparaat bevatten waardoor het apparaat volledig van het lichtnet afgesloten kan worden. Het isolatieapparaat moet een contactopening hebben met een minimale breedte van 3 mm.
- Dit apparaat wordt geleverd met stekker en netsnoer.

Kabeltypes die van toepassing zijn op de installatie of vervanging voor Europa:

H07 RN-F, H05 RN-F, H05 RRF, H05 VV-F, H05 V2V2-F (T90), H05 BB-F

Voor het deel van de kabel raadpleegt u het totale vermogen op het typeplaatje. U kunt ook de tabel raadplegen:

Totaal vermogen (W)	Doorsnede kabel (mm ²)
maximaal 1380	3 x 0.75
maximaal 2300	3 x 1
maximaal 3680	3 x 1.5

De aardkabel (groene/gele kabel) moet 2 cm langer zijn dan fase- en neutrale kabels (blauwe en bruine kabels).



2.3 Gebruik



WAARSCHUWING!

Gevaar voor letsel, brandwonden, elektrische schokken of een explosie.

- Dit apparaat is uitsluitend bestemd voor huishoudelijk gebruik.
- De specificatie van dit apparaat niet wijzigen.
- Zorg ervoor dat de ventilatieopeningen niet geblokkeerd zijn.
- Laat het apparaat tijdens het gebruik niet onbeheerd achter.
- Schakel het apparaat telkens na gebruik uit.
- Wees voorzichtig met het openen van de deur van het apparaat als het apparaat aan staat. Er kan hete lucht ontsnappen.
- Bedien het apparaat niet met natte handen of als het contact maakt met water.
- Oefen geen kracht uit op een geopende deur.
- Het apparaat mag niet worden gebruikt als werkblad of aanrecht.
- Open de deur van het apparaat voorzichtig. Als u alcoholische toevoegingen gebruikt, kan er alcohol-luchtmengsel ontstaan.
- Houd vonken of open vlammen uit de buurt van het apparaat bij het openen van de deur.
- Plaats geen ontvlambare producten of items die vochtig zijn door ontvlambare producten in, bij of op het apparaat.



WAARSCHUWING!

Risico op schade aan het apparaat.

- Om schade of verkleuring van het email te voorkomen:
 - zet geen kookgerei of andere voorwerpen direct op de bodem van het apparaat.

- leg geen aluminiumfolie op de bodem van de ruimte in het apparaat.
- plaats geen water direct in het hete apparaat.
- haal vochthoudende schotels en eten uit het apparaat als u klaar bent met koken.
- wees voorzichtig bij het verwijderen of bevestigen van accessoires.
- Verkleuring van het email of roestvrij staal is niet van invloed op de werking van het apparaat.
- Gebruik een diepe pan voor vochtige taarten. Fruitsappen kunnen permanente vlekken maken.
- Dit apparaat is uitsluitend bestemd om mee te koken. Het mag niet worden gebruikt voor andere doeleinden, zoals het verwarmen van een kamer.
- Alle bereidingen moeten worden uitgevoerd met gesloten ovendeur.
- Als het apparaat achter een meubelpaneel gemonteerd is (bijv. een deur), zorg er dan voor dat de deur nooit gesloten is als het apparaat in werking is. Warmte en vocht kunnen achter een gesloten meubelpaneel ophopen en schade aan het apparaat, de behuizing of de vloer veroorzaken. Sluit het meubelpaneel niet tot het apparaat volledig afgekoeld is na gebruik.

2.4 Onderhoud en reiniging



WAARSCHUWING!

Gevaar voor letsel, brand en schade aan het apparaat.

- Schakel het apparaat uit en trek de stekker uit het stopcontact voordat u onderhoudshandelingen verricht.
- Zorg ervoor dat het apparaat is afgekoeld. Er bestaat een risico dat de glasplaten kunnen breken.
- Vervang direct de glazen deurpanelen als deze beschadigd zijn. Neem contact op met een erkend servicecentrum.
- Wees voorzichtig als u de deur van het apparaat verwijdert. De deur is zwaar!
- Reinig het apparaat regelmatig om te voorkomen dat het materiaal van het oppervlak achteruitgaat.

- Maak het apparaat schoon met een vochtige zachte doek. Gebruik alleen neutrale schoonmaakmiddelen. Gebruik geen schuurmiddelen, schuursponsjes, oplosmiddelen of metalen voorwerpen.
- Volg als u een ovenspray gebruikt de aanwijzingen op de verpakking.

2.5 Binnenverlichting



WAARSCHUWING!

Gevaar voor elektrische schokken.

- Met betrekking tot de lamp(en) in dit product en reservelampen die afzonderlijk worden verkocht: Deze lampen zijn bedoeld om bestand te zijn tegen extreme fysieke omstandigheden in huishoudelijke apparaten, zoals temperatuur, trillingen, vochtigheid, of zijn bedoeld om informatie te geven over de operationele status van het apparaat. Ze zijn niet bedoeld voor gebruik in andere toepassingen en zijn niet geschikt voor verlichting in huishoudelijke ruimten.
- Gebruik alleen lampjes met dezelfde specificaties.

2.6 Service

- Neem contact op met de erkende servicedienst voor reparatie van het apparaat.
- Gebruik uitsluitend originele reserveonderdelen.

2.7 Afvalverwerking



WAARSCHUWING!

Gevaar voor letsel of verstikking.

- Haal de stekker uit het stopcontact.
- Snijd het netsnoer vlak bij het apparaat af en gooi het weg.
- Verwijder de deurvergrendeling om te voorkomen dat kinderen of huisdieren binnen in het apparaat vast komen te zitten.

3. MONTAGE



WAARSCHUWING!
Raadpleeg de hoofdstukken
Veiligheid.

3.1 Inbouwen

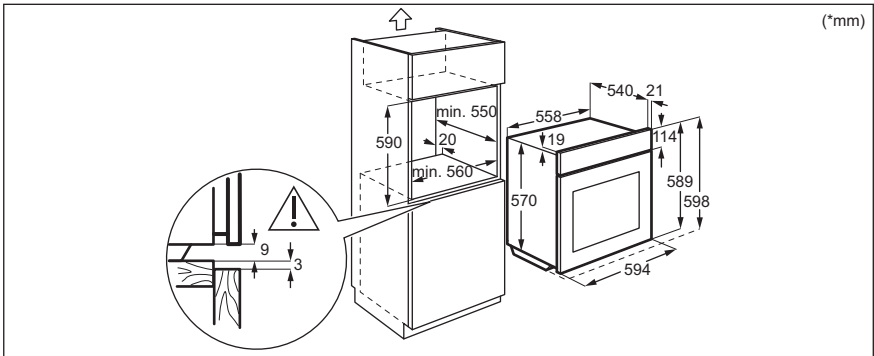
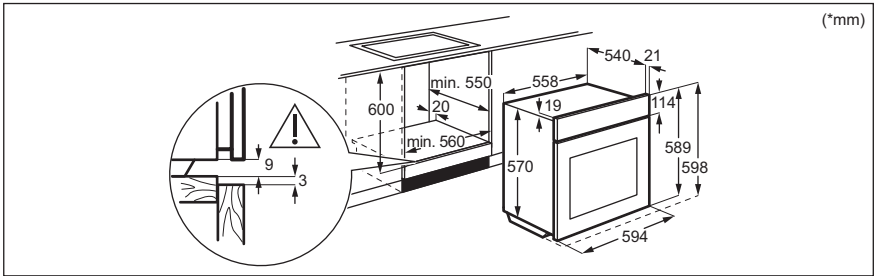

3.2 Bevestiging van de oven aan de kast

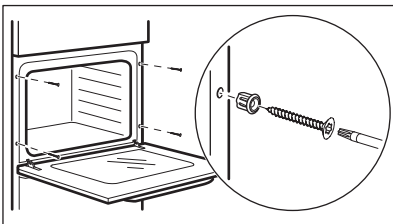

4. BESCHRIJVING VAN HET PRODUCT

4.1 Algemeen overzicht

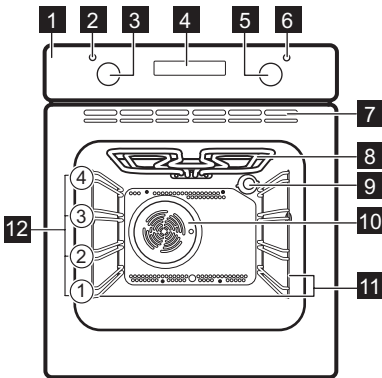

- 1 Bedieningspaneel
- 2 Aan/uit-lampje/symbool
- 3 Knop voor verwarmingsfuncties
- 4 Display
- 5 Bedieningsknop (voor de temperatuur)
- 6 Temperatuurindicator/symbool
- 7 Luchtopeningen voor koelventilator
- 8 Verwarmingselement
- 9 Lamp
- 10 Ventilator
- 11 Verwijderbare inschuifrail
- 12 Rekstanden

4.2 Accessoires

- **Bakrooster**
Voor kookgerei, bak- en braadvormen.

- **Bakplaat**
Voor gebak en koekjes.

5. BEDIENINGSPANEEL

5.1 Sensorveld / Knoppen

—	Om de tijd in te stellen.
⌚	De klokfunctie instellen.
+	Om de tijd in te stellen.

5.2 Display

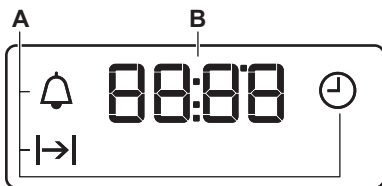

- A. Klokfuncties
- B. Timer

6. VOOR HET EERSTE GEBRUIK



WAARSCHUWING!

Raadpleeg de hoofdstukken
Veiligheid.

6.1 Voorafgaand aan het eerste gebruik

De oven kan een vreemde geur en rook afgeven tijdens het voorverwarmen. Zorg ervoor dat de kamer goed is geventileerd.



Stap 1



Stap 2



Stap 3

Stel de klok in	De oven reinigen	Verwarm de lege oven voor
<ol style="list-style-type: none">1. - druk hierop om de tijd in te stellen. Na ongeveer 5 seconden stopt het knipperen en geeft de klok de tijd weer.	<ol style="list-style-type: none">1. Haal alle accessoires en verwijderbare inschuifrails uit de oven.2. Reinig de oven en de accessoires met een zachte doek, warm water en een mild reinigingsmiddel.	<ol style="list-style-type: none">1. Stel de maximale temperatuur in voor de functie: . Tijd: 1 uur2. Stel de maximale temperatuur in voor de functie: . Tijd: 15 min3. Stel de maximale temperatuur in voor de functie: . Tijd: 15 min
Schakel de oven uit en wacht tot deze is afgekoeld. Plaats de accessoires en de verwijderbare inschuifrails in de oven.		

7. DAGELIJKS GEBRUIK



WAARSCHUWING!







Raadpleeg de hoofdstukken
Veiligheid.

7.1 Instellen: Verwarmingsfunctie

Stap 1	Draai aan de knop voor de verwarmingsfuncties om een verwarmingsfunctie te selecteren.
Stap 2	Draai aan de regelknop om de temperatuur te selecteren.
Stap 3	Draai wanneer het bereiden stopt aan de knoppen naar de uit-stand om de oven uit te schakelen.

7.2 Verwarmingsfuncties

Verwarmingsfunctie	Toepassing
 Uit-stand	De oven is uitgeschakeld.
 Binnenverlichting	Om de lamp in te schakelen.
 Hetelucht	Bakken op maximaal twee restanden tegelijkertijd en voedsel drogen. Stel de temperatuur 20 °C tot 40 °C lager in dan voor Boven- / onderwarmte.

Verwarmings-functie	Toepassing
 Warmelucht (vochtig)	Deze functie is ontworpen om tijdens de bereiding energie te besparen. Bij het gebruik van deze functie kan de temperatuur in de ruimte verschillen van de ingestelde temperatuur. Het verwarmingsvermogen kan worden verminderd. Raadpleeg voor meer informatie het hoofdstuk "Dagelijks gebruik", opmerkingen op: Warmelucht (vochtig).
 Onderwarmte	Voor het bakken van taarten met een knapperige bodem en het inmaken van voedsel.
 Ontdooien	Om voedsel te ontdooien (groenten en fruit). De ontdooitijd hangt af van de hoeveelheid en dikte van het voedsel.
 Grill	Voor het roosteren van dunne stukjes voedsel en voor het maken van toast.
 Grill Intens	Voor het roosteren van dunne stukjes voedsel in grote hoeveelheden en voor het maken van toast.
 Turbo grill	Voor het braden van grotere stukken vlees of gevogelte met botten op één niveau. Voor gratineren en bruinen.

Verwarmings-functie	Toepassing
 Boven- /onder-warmte	Voor het bakken en braden op één rekstand.

7.3 Toelichting van: Warmelucht (vochtig)



Deze functie wordt gebruikt om te voldoen aan de energie-efficiëntieklasse en ecodesign-vereisten overeenkomstig EU 65/2014 en EU 66/2014. Testen volgens EN 60350-1.

De ovendeur dient tijdens de bereiding gesloten te zijn zodat de functie niet wordt onderbroken en de oven werkt op de hoogst mogelijke energie-efficiëntie.

Zie het hoofdstuk 'Hints and tips', Warmelucht (vochtig) voor bereidingsinstructies. Zie voor algemene aanbevelingen voor energiebesparing het hoofdstuk 'Energie-efficiëntie', Energiebesparing.

8. KLOKFUNCTIES

8.1 Klokfuncties

Klokfunctie	Toepassing
 Tijdstip van de dag	Met deze functie kunt u de dagtijd instellen, wijzigen of controleren.
 Duur	Instellen hoe lang de oven in werking is.
 Kookwekker	Om een afteltijd in te stellen. Deze functie heeft geen invloed op de werking van de oven. U kunt deze functie op elk gewenst moment instellen, ook als de oven uit staat.

8.2 Instellen: Klokfuncties



Instellen: Tijdstip van de dag

 - knippert als je de oven aansluit op het stopcontact, als er een stroomstoring is geweest of als de timer niet is ingesteld.

 - druk hierop om de tijd in te stellen.

Na ongeveer 5 seconden stopt het knipperen en geeft de klok de tijd weer.

Wijzigen: Tijdstip van de dag



Stap 1  - druk hier herhaaldelijk op om het tijdstip van de dag te wijzigen.  - begint te knipperen.

Stap 2  - druk hierop om de tijd in te stellen.

Na ongeveer 5 seconden stopt het knipperen en geeft de klok de tijd weer.

Instellen: Duur

Stap 1 Stel een ovenfunctie en de temperatuur in.

Stap 2  - druk hier herhaaldelijk op  - begint te knipperen.

Stap 3  - druk hierop om de duur in te stellen.

Op het display verschijnt: .

 - knippert wanneer de ingestelde tijd is verstreken. Er weerklinkt een geluidssignaal en de oven schakelt uit.

Stap 4 Druk op een willekeurige toets om het signaal te stoppen.

Stap 5 Draai de knoppen naar de uitstand.

Instellen: Kookwekker

Stap 1  - druk hier herhaaldelijk op  - begint te knipperen.

Stap 2  - druk hierop om de tijd in te stellen.

De functie wordt automatisch na 5 seconden gestart.

Wanneer de ingestelde tijd is verstreken, klinkt er een geluidssignaal.

Stap 3 Druk op een willekeurige toets om het signaal te stoppen.

Stap 4 Draai de knoppen naar de uitstand.

Annuleren: Klokfuncties

Stap 1  - druk herhaaldelijk totdat het klokfunctiesymbool begint te knipperen.

Stap 2 Ingedrukt houden: .

De klokfunctie schakelt na enkele seconden uit.

9. GEBRUIK VAN DE ACCESSOIRES



WAARSCHUWING!

Raadpleeg de hoofdstukken
Veiligheid.

9.1 Accessoires plaatsen

Een kleine inkeping bovenaan verhoogt de
veiligheid. Deze inkepingen voorkomen

Bakrooster:

Plaats het rooster tussen de geleidestangen van
de inschuifrails zorg ervoor dat de pootjes om-
laag wijzen.

bovendien omkanteling. De hoge rand rond
het rooster voorkomt dat het kookgerei van
het rooster afglijdt.

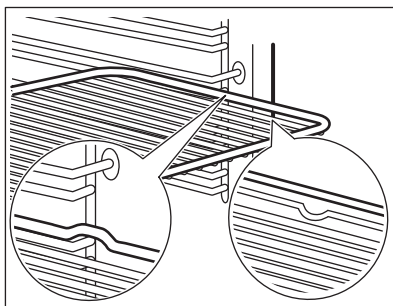

Bakplaat:

Schuif de plaat tussen de geleidestangen van de
inschuifrail.

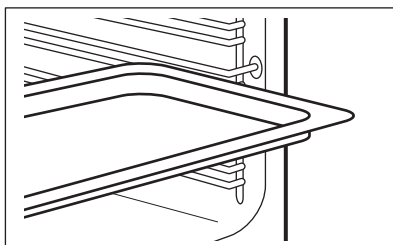

Bakrooster, Bakplaat:

Plaats de plaat tussen de geleiders van de in-
schuifrails en het bakrooster op de geleiders erbo-
ven.

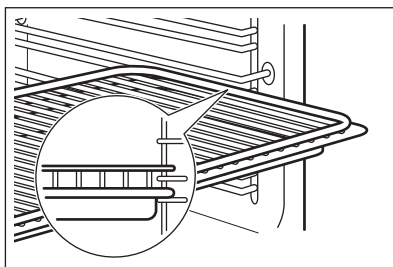

10. EXTRA FUNCTIES

10.1 Koelventilator

Als de oven in werking is, wordt de koelventilator automatisch ingeschakeld om de oppervlakken van de oven koel te houden. Als u de oven uitschakelt, kan de koelventilator blijven werken totdat de oven is afgekoeld.

10.2 Veiligheidsthermostaat

Een onjuiste bediening van de oven of defecte componenten kunnen gevaarlijke

oververhitting veroorzaken. Om dit te voorkomen is de oven voorzien van een veiligheidsthermostaat die de stroomtoevoer onderbreekt. Zodra de temperatuur is gedaald, wordt de oven automatisch weer ingeschakeld.

11. AANWIJZINGEN EN TIPS



Raadpleeg de hoofdstukken Veiligheid.

11.1 Kookadviezen

De oven heeft vier rekniveaus.

Tel de rekniveaus vanaf de bodem van de oven.

Uw oven kan anders bakken of roosteren dan de oven die u tot nu toe gebruikt heeft. In de onderstaande tabel vindt u de standaardinstellingen voor temperatuur, kooktijd en roosterniveau.

Als u voor een speciaal recept de instelling niet kunt vinden, zoek dan naar een soortgelijk recept.

De oven heeft een speciaal systeem dat de lucht circuleert en voor doorlopende recycling van stoom zorgt. Dankzij dit systeem is het mogelijk om voedsel te bereiden in een atmosfeer met stoom en worden de gerechten zacht van binnen en knapperig van buiten. Dit reduceert zowel de bereidingstijd als het energieverbruik.

Voor de bereiding van gebak

De ovendeur mag pas worden geopend als driekwart van de baktijd is verstreken.

Als u twee bakplaten tegelijkertijd gebruikt, dient u één niveau ertussen leeg te laten.

Voor de bereiding van vlees en vis

Laat het vlees ongeveer 15 minuten rusten voordat u het aansnijdt, zodat het vleessap er niet uit stroomt.







Om te veel rook tijdens het braden in de oven te vermijden, kunt u een beetje water in de lekbak gieten. Om rook te vermijden, voegt u water toe wanneer het is opgedroogd.

Bereidingstijden







De bereidingsduur is afhankelijk van het soort voedsel, de samenstelling en het volume.







Houd in eerste instantie het bereidingsproces in de gaten. Zoek bij het gebruik van dit apparaat de beste instellingen (temperatuur, bereidingsduur, etc.) voor uw kookgerei, recepten en hoeveelheden.

11.2 Bakken en roosteren







 CAKES	Boven- /onderwarm- te		Hetelucht		 (min)	
	 (°C)		 (°C)			
Recepten met klopper	170	2	160	2 (1 en 3)	45 - 60	Cakevorm
Zandkoekjesdeeg	170	2	160	2 (1 en 3)	24 - 34	Cakevorm
Kwarktaart met karnemelk	170	1	160	2	60 - 80	Cakevorm, Ø 26 cm
Strudel	175	2	150	2	60 - 80	Bakplaat
Jamtaart	170	2	160	2	30 - 40	Cakevorm, Ø 26 cm
Vruchtencake	170	2	155	2	60 - 70	Cakevorm, Ø 26 cm
Kerstkrans / Rijke vruchtencake	170	2	160	2	50 - 60	Cakevorm, Ø 20 cm
Pruimenttaart, verwarm de oven voor	170	2	160	2	50 - 60	Broodvorm
Koekjes, verwarm de oven voor	150	3	150	3	20 - 30	Bakplaat
Schuimgebakjes	100	3	100	3	90 - 120	Bakplaat
Broodjes, verwarm de oven voor	190	3	180	3	15 - 20	Bakplaat
Soesjesdeeg, verwarm de oven voor	190	3	180	3	25 - 35	Bakplaat
Taartjes	180	3	170	2	45 - 70	Cakevorm, Ø 20 cm
Victoriataart met jamvulling	180	1 of 2	170	2	40 - 55	Cakevorm, Ø 20 cm

Verwarm de lege oven voor.

 BROOD EN PIZZA	Boven- /onderwarm- te		Hetelucht		 (min)	
	 (°C)		 (°C)			
Witbrood, 1 - 2 stuks, 0,5 kg elk	190	1	190	1	60 - 70	-
Roggebrood, voorverwarming is niet nodig	190	1	180	1	30 - 45	Broodvorm





 BROOD EN PIZZA	Boven- /onderwarm- te		Hetelucht		 (min)	
	 (°C)		 (°C)			
Broodjes, 6 - 8 broodjes	190	2	180	2 (1 en 3)	25 - 40	Bakplaat
Pizza	190	1	190	1	20 - 30	Braadpan
Scones	200	3	190	2	10 - 20	Bakplaat







Gebruik de taartvorm.







 FLANS	Boven- /onderwarmte		Hetelucht		 (min)
	 (°C)		 (°C)		
Pastataart	180	2	180	2	40 - 50
Hartige groentetaart	200	2	175	2	45 - 60
Quiches	190	1	190	1	40 - 50
Lasagne	200	2	200	2	25 - 40
Cannelloni	200	2	190	2	25 - 40
Yorkshire pudding, 6 puddingvormen, verwarm de oven voor	220	2	210	2	20 - 30

Gebruik de tweede rekstand.

Maak gebruik van het bakrooster.

 VLEES	Boven- /onderwarm- te		Hetelucht		 (min)
	 (°C)		 (°C)		
Rundvlees	200		190		50 - 70
Varkensvlees	180		180		90 - 120
Kalfsvlees	190		175		90 - 120
Engelse rosbeef, rood	210		200		44 - 50
Engelse rosbeef, medium	210		200		51 - 55
Engelse biefstuk, bien cuit	210		200		55 - 60

 VLEES	Boven- /onderwarmte		Hetelucht		 (min)
	 (°C)		 (°C)		
Varkensbraadstuk, met zwoerd	180	2	170	2	120 - 150
Varkensschenkel, 2 stuks	180	2	160	2	100 - 120
Lamsbout	190	2	190	2	110 - 130
Hele kip	200	2	200	2	70 - 85
Hele kalkoen	180	1	160	1	210 - 240
Hele eend	175	2	160	2	120 - 150
Hele gans	175	1	160	1	150 - 200
Konijn, in stukken gesneden	190	2	175	2	60 - 80
Haas, in stukken gesneden	190	2	175	2	150 - 200
Hele fazant	190	2	175	2	90 - 120





 VIS	Boven- /onderwarmte		Hetelucht		 (min)
	 (°C)		 (°C)		
Forel / Zeebrasem, 3 - 4 vis-sen	190	2	175	2 (1 en 3)	40 - 55
Tonijn / Zalm, 4 - 6 filets	190	2	175	2 (1 en 3)	35 - 60

11.3 Grill

Verwarm de lege oven voor.

Gebruik de derde rekstand.

Stel de temperatuur in op 250 °C.

 GRILLEN	 (kg)	 (min)	 (min)
		1e kant	2e kant
Ossenhaas, 4 stuks	0,8	12 - 15	12 - 14
Biefstuk, 4 stuks	0,6	10 - 12	6 - 8
Worstjes, 8	-	12 - 15	10 - 12
Varkenskoteletten, 4 stuks	0,6	12 - 16	12 - 14
Halve kip, 2	1	30 - 35	25 - 30
Kebabs, 4	-	10 - 15	10 - 12



GRILLEN



(kg)



(min)
1e kant



(min)
2e kant

	(kg)	(min) 1e kant	(min) 2e kant
Kippenborst, 4 stuks	0,4	12 - 15	12 - 14
Hamburgers, 6	0,6	20 - 30	-
Visfilet, 4 stuks	0,4	12 - 14	10 - 12
Geroosterde sandwiches, 4 - 6	-	5 - 7	-
Geroosterd brood, 4 - 6	-	2 - 4	2 - 3

11.4 Turbo grill

Verwarm de lege oven voor.

Stel de temperatuur in op 200 °C.

Gebruik de derde rekstand.



(min)

(kg)

1e kant

2e kant

	(kg)	1e kant	2e kant
Rollade, kalkoen	1	30 - 40	20 - 30
Halve kip, 2	1	25 - 30	20 - 30
Kippendrumsticks, 6 stuks	-	15 - 20	15 - 18
Kwartel, 4 stuks	0,5	25 - 30	20 - 25
Groentegratin	-	20 - 25	-
Sint-jakobsschelpen	-	15 - 20	-
Makreel, 2 - 4	-	15 - 20	10 - 15
Vismoten, 4 - 6	0,8	12 - 15	8 - 10

11.5 Ontdooien



(kg)







Ontdooitijd
(min.)



Nadooitijd (min)



Kip	1	100 - 140	20 - 30	Leg de kip op een omgekeerde onderschotel in een groot bord. Halverwege de bereidingstijd om-draaien.
-----	---	-----------	---------	---

	 (kg)	 Ontdooitijd (min.)	 Nadooitijd (min)	
Vlees	1 0,5	100 - 140 90 - 120	20 - 30	Halverwege de bereidings- tijd omdraaien.
Room	2 x 0,2	80 - 100	10 - 15	Room kan ook met nog licht bevroren deeltjes goed worden geklopt.
Forel	0,15	25 - 35	10 - 15	-
Aardbeien	0,3	30 - 40	10 - 20	-
Boter	0,25	30 - 40	10 - 15	-
Taart	1,4	60	60	-

11.6 Warmelucht (vochtig) - aanbevolen accessoires

Gebruik de donkere en niet-reflecterende bakjes en schalen. Ze nemen de warmte beter op dan licht en reflecterend servies.



Pizza pan

Donker, niet-reflecterend
Diameter van 28 cm



Ovenschotel

Donker, niet-reflecterend
Diameter van 26 cm



Ovenschaaltjes

Keramik
8 cm diameter, 5
cm hoog













Blik voor flanbodem

Donker, niet-reflecterend
Diameter van 28 cm

11.7 Warmelucht (vochtig)







Volg voor de beste resultaten de volgende aanwijzingen op die hieronder in de tabel staan.







		 (°C)		 (min)
Zoete broodjes, 12 stuks	bakplaat of lekschaal	180	2	35 - 40
Broodjes, 9 stuks	bakplaat of lekschaal	180	2	35 - 40
Pizza, bevroren, 0,35 kg	rooster	220	2	35 - 40
Koninginnenbrood (opgerolde cake met jam)	bakplaat of lekschaal	170	2	30 - 40

		 (°C)		 (min)
Brownie	bakplaat of lekschaal	180	2	30 - 40
Soufflé, 6 stuks	keramieken vormpjes op rooster	200	3	30 - 40
Luchtige vlaaibodem	flanvorm op rooster	170	2	20 - 30
Victoriataart met jamvulling	ovenschaal op rooster	170	2	35 - 45
Gepocheerde vis, 0,3 kg	bakplaat of lekschaal	180	3	35 - 45
Hele vis, 0,2 kg	bakplaat of lekschaal	180	3	35 - 45
Visfilet, 0,3 kg	pizzavorm op rooster	180	3	35 - 45
Gepocheerd vlees, 0,25 kg	bakplaat of lekschaal	200	3	40 - 50
Sjasliëk, 0,5 kg	bakplaat of lekschaal	200	3	25 - 35
Koekjes, 16 stuks	bakplaat of lekschaal	180	2	20 - 30
Makarons, 20 stuks	bakplaat of lekschaal	180	2	40 - 45
Muffins, 12 stuks	bakplaat of lekschaal	170	2	30 - 40
Hartig gebak, 16 stuks	bakplaat of lekschaal	170	2	35 - 45
Zandkoekjes, 20 stuks	bakplaat of lekschaal	150	2	40 - 50
Taartjes, 8 stuks	bakplaat of lekschaal	170	2	20 - 30
Groenten, gepocheerd, 0,4 kg	bakplaat of lekschaal	180	3	35 - 40
Vegetarisch omelet	pizzavorm op rooster	200	3	30 - 45
Mediterrane groenten, 0,7 kg	bakplaat of lekschaal	180	4	35 - 40

11.8 Aanwijzingen voor testinstituten

Testen volgens IEC 60350-1.

				 (°C)	 (min)	
Kleine cakes, 20 stuks per bakplaat	Boven- /onderwarmte	Bakplaat	3	170	20 - 30	-
Appeltaart, 2 blikken Ø20 cm	Boven- /onderwarmte	Bakrooster	1	170	80 - 120	-

						
				(°C)	(min)	
Biscuitgebak, taartvorm Ø26 cm	Boven- /onder-warmte	Bakrooster	2	170	35 - 45	-
Zandtaart-deeg	Boven- /onder-warmte	Bakplaat	3	150	20 - 35	Verwarm de oven 10 minuten voor.
Geroosterd brood, 4 - 6 stuks	Grill	Bakrooster	3	max.	2 - 4 minuten eerste kant; 2 - 3 minuten tweede kant	Verwarm de oven 3 minuten voor.
Runderburger, 6 stuks, 0,6 kg	Grill	Rooster en lekbak	3	max.	20 - 30	Plaats het rooster op het derde niveau en de lekbak op het tweede niveau in de oven. Draai het voedsel halverwege de bereidingstijd om. Verwarm de oven 3 minuten voor.

12. ONDERHOUD EN REINIGING



WAARSCHUWING!

Raadpleeg de hoofdstukken
Veiligheid.

12.1 Opmerkingen over schoonmaken



Reinigingsmid-
delen

Maak de voorkant van de oven schoon met een zachte doek, warm water en een mild reinigingsmiddel. Reinig en controleer de deurpakking rond het frame van de uitsparing.

Gebruik een reinigungsoplossing om metalen oppervlakken te reinigen.

Reinig vlekken met een mild reinigungsmiddel.



Dagelijks gebruik

Reinig de uitsparing telkens na gebruik. Vetophoping of andere resten kunnen brand veroorzaken.

Vocht kan in de oven of op de glazen deurpanelen condenseren. Om de condens te verminderen, dient u de oven 10 minuten te laten werken voordat u er iets in plaatst. Bewaar het voedsel niet langer dan 20 minuten in de oven. Droog de uitsparing na elk gebruik met een zachte doek.



Accessoires

Reinig alle accessoires na elk gebruik en laat ze drogen. Gebruik een zachte doek met warm water en een mild reinigungsmiddel. De accessoires niet in de afwasmachine reinigen.

Reinig de antiaanbakaccessoires niet met agressieve reinigungsmiddelen of scherpe voorwerpen.

12.2 Hoe te verwijderen: Inschuifrails/

Verwijder de inschuifrails om de oven te reinigen.

Stap 1 Schakel de oven uit en wacht tot deze afgekoeld is.

Stap 2 Trek de inschuifrail bij de voorkant uit de zijwand.

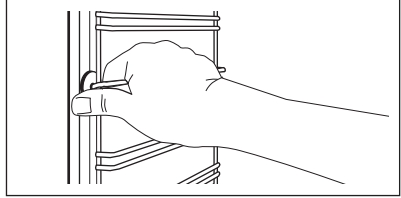

Stap 3 Trek de inschuifrail bij de achterkant uit de zijwand en verwijder deze.

Stap 4 Installeer de inschuifrails in de omgekeerde volgorde.

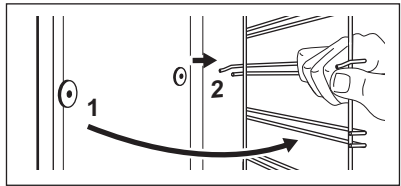

12.3 Hoe te verwijderen en installeren: Deur

De ovendeur beschikt over twee glasplaten. U kunt de ovendeur en de interne glasplaat verwijderen om ze schoon te maken. Lees de volledige instructie 'Verwijderen van installatiedeur' voordat u de glasplaten verwijdert.



LET OP!

Gebruik de oven nooit zonder de glasplaten.

Stap 1 Open de deur volledig en houd beide scharnieren vast.

Stap 2

Til de hendel op beide scharnieren volledig omhoog en draai het.

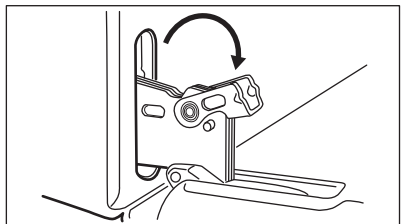
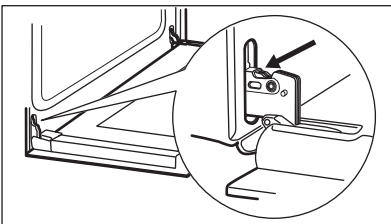

Stap 3 Sluit de ovendeur halverwege tot de eerste openingsstand. Til hem daarna op en trek hem naar voren en verwijder hem van zijn plek.

Stap 4

Plaats de deur op een zachte doek op een stabiele ondergrond en ontgrendel het vergrendelingssysteem om de interne glasplaat te verwijderen.

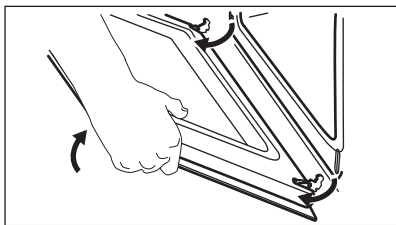

Stap 5 Draai de bevestigingen 90° en verwijder ze uit hun zittingen.

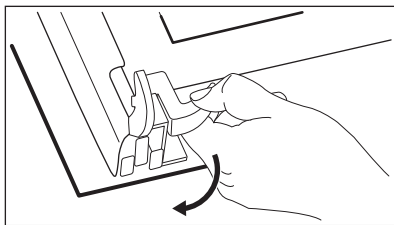

Stap 6 De glasplaat eerst voorzichtig optillen en dan verwijderen.

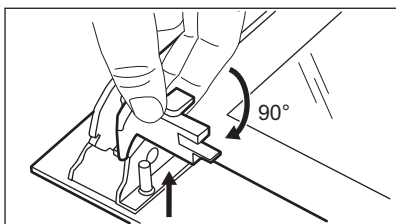

Stap 7 Reinig de glasplaten met een sopje. Droog de glasplaten voorzichtig af. Reinig de glasplaten niet in de vaatwasser.

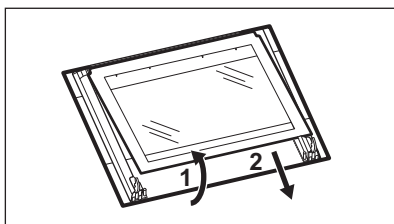

Stap 8 Installeer na het reinigen de glasplaat en de ovendeur.

Als de deur correct wordt geïnstalleerd, klikt de rand van de deur.
Zorg ervoor dat u de interne glasplaat correct in de uitsparingen plaatst.

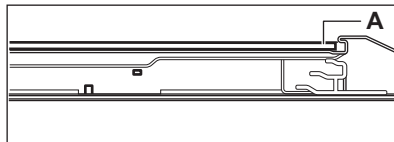

12.4 Hoe te vervangen: Lamp



WAARSCHUWING!
Gevaar voor elektrische schokken.
Het lampje kan heet zijn.

Voordat u de lamp vervangt:

Stap 1

Schakel de oven uit. Wacht tot de oven afgekoeld is.

Stap 2

Trek de oven uit het stopcontact.

Stap 3

Plaats een doek op de bodem van de holte.

Achterlamp

- Stap 1** Draai de glazen afdekking om die te verwijderen.
-
- Stap 2** Reinig het glazen deksel.
-
- Stap 3** Vervang de lamp door een geschikte hittebestendige lamp van 300 °C.
-
- Stap 4** Installeer het glazen deksel.
-

13. PROBLEEMOPLOSSING



WAARSCHUWING!

Raadpleeg de hoofdstukken
Veiligheid.

13.1 Wat te doen in de volgende gevallen...

Neem in alle gevallen die niet in deze tabel zijn opgenomen contact op met een erkend servicecentrum.

Probleem	Controleer of de volgende zaken gelden...
De oven wordt niet warm.	De zekering is doorgeslagen.
De deurpakking is beschadigd.	Gebruik de oven niet. Neem contact op met een erkend servicecentrum.

Probleem	Controleer of de volgende zaken gelden...
Op het display wordt "12.00" weergegeven.	Er is een stroomstoring geweest. Stel de dagtijd in.
De lamp werkt niet.	De lamp is opgebrand.

13.2 Onderhoudsgegevens

Als u niet zelf het probleem kunt verhelpen, neem dan contact op met uw verkoper of een erkende serviceafdeling.

De contactgegevens van het servicecentrum staan op het typeplaatje. Het typeplaatje bevindt zich aan de voorkant van de binnenkant van de oven. Verwijder het typeplaatje niet uit de ovenruimte.

Wij adviseren u om de gegevens hier te noteren:

Model (MOD.)

Productnummer (PNC)

Serienummer (S.N.)

14. ENERGIEZUINIGHEID

14.1 Productinformatie- en productinformatieblad*

Naam leverancier	Zanussi
Modelidentificatie	ZOHEE2X1 944068087 ZOHIE2X1 944068089
Energie-efficiëntie-index	94.9

Energie-efficiëntieklasse	A	
Energieverbruik bij een standaardbelasting, stand boven + onder-warmte	0.83 kWh/cyclus	
Energieverbruik bij een standaardbelasting, stand hetelucht	0.75 kWh/cyclus	
Aantal ruimten	1	
Warmtebron	Elektriciteit	
Volume	57 l	
Soort oven	Inbouwoven	
Massa	ZOHEE2X1	28.6 kg
	ZOHIE2X1	28.6 kg

* Voor de Europese Unie overeenkomstig EU-verordeningen 65/2014 en 66/2014.
 Voor de Republiek Belarus overeenkomstig STB 2478-2017, aanhangsel G; STB 2477-2017, bijlagen A en B.
 Voor Oekraïne overeenkomstig 568/32020.

De energie-efficiëntieklasse is niet van toepassing op Rusland.

EN 60350-1 - Elektrische huishoudelijke kookapparaten - Deel 1: Range-ovens, ovens, stoomovens en grills - Methoden voor prestatiemeting.

14.2 Energiebesparing



Deze oven bevat functies die u helpen energie te besparen tijdens het dagelijks koken.

Zorg ervoor dat de ovendeur gesloten is als u de oven in werking stelt. Open de ovendeur niet te vaak tijdens gebruik. Houd het deurrubber schoon en zorg ervoor dat het goed op zijn plaats vastzit.

Gebruik metalen kookgerei om meer energie te besparen.

Verwarm de oven indien mogelijk niet voor het koken voor.

Houd de onderbrekingen tussen het bakken zo kort mogelijk als u een aantal gerechten tegelijkertijd bereidt.

Bereiding met hete lucht

Gebruik indien mogelijk de bereidingsfuncties met hete lucht om energie te besparen.

Restwarmte

Wanneer de kookduur langer is dan 30 minuten, verlaag dan de oventemperatuur tot minimaal 3-10 minuten voor het einde van het koken. De restwarmte in de oven zorgt ervoor dat het gerecht wordt voltooid.

U kunt de restwarmte gebruiken om andere maaltijden op te warmen.

Eten warm houden

Kies de laagst mogelijke temperatuurinstelling om de restwarmte te gebruiken en een maaltijd warm te houden.

Warmelucht (vochtig)

Functie is ontworpen om tijdens de bereiding energie te besparen.

15. MILIEUBESCHERMING

Recycleer de materialen met het symbool



Gooi de verpakking in een geschikte afvalcontainer om het te recycleren.

Bescherm het milieu en de volksgezondheid en recycleer op een correcte manier het afval van elektrische en elektronische apparaten. Gooi apparaten gemarkeerd met het symbool

 niet weg met het huishoudelijk afval. Breng het product naar het milieustation bij u in de buurt of neem contact op met de gemeente.

VISIT OUR WEBSITE TO:



Get usage advice, brochures, trouble shooter, service and repair information:
www.zanussi.com/support

Subject to change without notice.

CONTENTS

1. SAFETY INFORMATION.....	26
2. SAFETY INSTRUCTIONS.....	28
3. INSTALLATION.....	30
4. PRODUCT DESCRIPTION.....	31
5. CONTROL PANEL.....	32
6. BEFORE FIRST USE.....	32
7. DAILY USE.....	33
8. CLOCK FUNCTIONS.....	34
9. USING THE ACCESSORIES.....	35
10. ADDITIONAL FUNCTIONS.....	36
11. HINTS AND TIPS.....	36
12. CARE AND CLEANING.....	43
13. TROUBLESHOOTING.....	45
14. ENERGY EFFICIENCY.....	46

1. ⚠ SAFETY INFORMATION

Before the installation and use of the appliance, carefully read the supplied instructions. The manufacturer is not responsible for any injuries or damage that are the result of incorrect installation or usage. Always keep the instructions in a safe and accessible location for future reference.

1.1 Children and vulnerable people safety

- This appliance can be used by children aged from 8 years and above and persons with reduced physical, sensory or mental capabilities or lack of experience and knowledge if they have been given supervision or instruction concerning the use of the appliance in a safe way and understand the hazards involved. Children of less than 8 years of age and persons with very extensive and complex disabilities shall be kept away from the appliance unless continuously supervised.

- Do not let children play with the appliance.
- Keep all packaging away from children and dispose of it appropriately.
- **WARNING:** Keep children and pets away from the appliance when it operates or when it cools down. Accessible parts become hot during use.
- If the appliance has a child safety device, it should be activated.
- Children shall not carry out cleaning and user maintenance of the appliance without supervision.

1.2 General Safety

- Only a qualified person must install this appliance and replace the cable.
- **WARNING:** The appliance and its accessible parts become hot during use. Care should be taken to avoid touching heating elements.
- Always use oven gloves to remove or put in accessories or ovenware.
- Before carrying out any maintenance, disconnect the appliance from the power supply.
- **WARNING:** Ensure that the appliance is switched off before replacing the lamp to avoid the possibility of electric shock.
- Do not use the appliance before installing it in the built-in structure.
- Do not use a steam cleaner to clean the appliance.
- Do not use harsh abrasive cleaners or sharp metal scrapers to clean the glass door since they can scratch the surface, which may result in shattering of the glass.
- If the mains power supply cable is damaged, it must be replaced by the manufacturer, its Authorised Service Centre or similarly qualified persons to avoid an electrical hazard.
- To remove the shelf supports first pull the front of the shelf support and then the rear end away from the side walls. Install the shelf supports in the opposite sequence.

2. SAFETY INSTRUCTIONS

2.1 Installation



WARNING!

Only a qualified person must install this appliance.

- Remove all the packaging.
- Do not install or use a damaged appliance.
- Follow the installation instructions supplied with the appliance.
- Always take care when moving the appliance as it is heavy. Always use safety gloves and enclosed footwear.
- Do not pull the appliance by the handle.
- Install the appliance in a safe and suitable place that meets installation requirements.
- Keep the minimum distance from other appliances and units.
- Before mounting the appliance, check if the oven door opens without restraint.
- The appliance is equipped with an electric cooling system. It must be operated with the electric power supply.

Cabinet minimum height (Cabinet under the worktop minimum height)	590 (600) mm
---	--------------

Cabinet width	560 mm
---------------	--------

Cabinet depth	550 (550) mm
---------------	--------------

Height of the front of the appliance	598 mm
---	--------

Height of the back of the appliance	579 mm
--	--------

Width of the front of the ap- pliance	594 mm
--	--------

Width of the back of the appliance	558 mm
---------------------------------------	--------

Depth of the appliance	561 mm
------------------------	--------

Built in depth of the appli- ance	540 mm
--------------------------------------	--------

Depth with open door	1007 mm
----------------------	---------

Ventilation opening mini- mum size. Opening placed on the bottom rear side	560x20 mm
--	-----------

Mains supply cable length. Cable is placed in the right corner of the back side	1100 mm
---	---------

Mounting screws

4x25 mm

2.2 Electrical connection



WARNING!

Risk of fire and electric shock.

- All electrical connections should be made by a qualified electrician.
- The appliance must be earthed.
- Make sure that the parameters on the rating plate are compatible with the electrical ratings of the mains power supply.
- Always use a correctly installed shockproof socket.
- Do not use multi-plug adapters and extension cables.
- Make sure not to cause damage to the mains plug and to the mains cable. Should the mains cable need to be replaced, this must be carried out by our Authorised Service Centre.
- Do not let mains cables touch or come near the appliance door or the niche below the appliance, especially when it operates or the door is hot.
- The shock protection of live and insulated parts must be fastened in such a way that it cannot be removed without tools.
- Connect the mains plug to the mains socket only at the end of the installation. Make sure that there is access to the mains plug after the installation.
- If the mains socket is loose, do not connect the mains plug.
- Do not pull the mains cable to disconnect the appliance. Always pull the mains plug.
- Use only correct isolation devices: line protecting cut-outs, fuses (screw type fuses removed from the holder), earth leakage trips and contactors.
- The electrical installation must have an isolation device which lets you disconnect the appliance from the mains at all poles. The isolation device must have a contact opening width of minimum 3 mm.
- This appliance is supplied with a main plug and a main cable.

Cable types applicable for installation or replacement for Europe:

H07 RN-F, H05 RN-F, H05 RRF, H05 VV-F, H05 V2V2-F (T90), H05 BB-F

For the section of the cable refer to the total power on the rating plate. You can also refer to the table:

Total power (W)	Section of the cable (mm ²)
maximum 1380	3 x 0.75
maximum 2300	3 x 1
maximum 3680	3 x 1.5

The earth cord (green / yellow cable) must be 2 cm longer than phase and neutral cables (blue and brown cables).



2.3 Use



WARNING!

Risk of injury, burns and electric shock or explosion.

- This appliance is for household use only.
- Do not change the specification of this appliance.
- Make sure that the ventilation openings are not blocked.
- Do not let the appliance stay unattended during operation.
- Deactivate the appliance after each use.
- Be careful when you open the appliance door while the appliance is in operation. Hot air can release.
- Do not operate the appliance with wet hands or when it has contact with water.
- Do not apply pressure on the open door.
- Do not use the appliance as a work surface or as a storage surface.
- Open the appliance door carefully. The use of ingredients with alcohol can cause a mixture of alcohol and air.
- Do not let sparks or open flames to come in contact with the appliance when you open the door.

- Do not put flammable products or items that are wet with flammable products in, near or on the appliance.



WARNING!

Risk of damage to the appliance.

- To prevent damage or discoloration to the enamel:
 - do not put ovenware or other objects in the appliance directly on the bottom.
 - do not put aluminium foil directly on the bottom of cavity of the appliance.
 - do not put water directly into the hot appliance.
 - do not keep moist dishes and food in the appliance after you finish the cooking.
 - be careful when you remove or install the accessories.
- Discoloration of the enamel or stainless steel has no effect on the performance of the appliance.
- Use a deep pan for moist cakes. Fruit juices cause stains that can be permanent.
- This appliance is for cooking purposes only. It must not be used for other purposes, for example room heating.
- Always cook with the oven door closed.
- If the appliance is installed behind a furniture panel (e.g. a door) make sure the door is never closed when the appliance operates. Heat and moisture can build up behind a closed furniture panel and cause subsequent damage to the appliance, the housing unit or the floor. Do not close the furniture panel until the appliance has cooled down completely after use.

2.4 Care and cleaning



WARNING!

Risk of injury, fire, or damage to the appliance.

- Before maintenance, deactivate the appliance and disconnect the mains plug from the mains socket.
- Make sure the appliance is cold. There is the risk that the glass panels can break.
- Replace immediately the door glass panels when they are damaged. Contact the Authorised Service Centre.

- Be careful when you remove the door from the appliance. The door is heavy!
- Clean regularly the appliance to prevent the deterioration of the surface material.
- Clean the appliance with a moist soft cloth. Use only neutral detergents. Do not use abrasive products, abrasive cleaning pads, solvents or metal objects.
- If you use an oven spray, follow the safety instructions on its packaging.

2.5 Internal lighting



WARNING!
Risk of electric shock.

- Concerning the lamp(s) inside this product and spare part lamps sold separately: These lamps are intended to withstand extreme physical conditions in household appliances, such as temperature, vibration, humidity, or are intended to signal information about the operational status of the appliance. They are not

intended to be used in other applications and are not suitable for household room illumination.

- Use only lamps with the same specifications.

2.6 Service

- To repair the appliance contact the Authorised Service Centre.
- Use original spare parts only.

2.7 Disposal



WARNING!
Risk of injury or suffocation.

- Disconnect the appliance from the mains supply.
- Cut off the mains electrical cable close to the appliance and dispose of it.
- Remove the door catch to prevent children or pets from becoming trapped in the appliance.

3. INSTALLATION



WARNING!
Refer to Safety chapters.

3.1 Building in

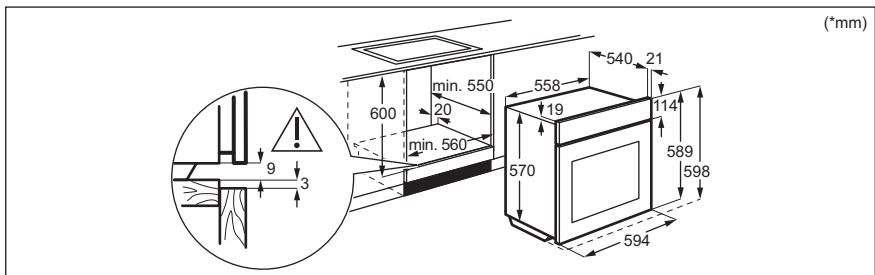

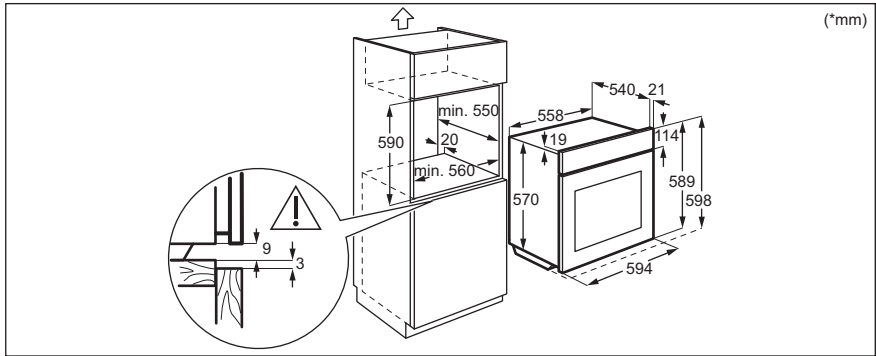

3.2 Securing the oven to the cabinet

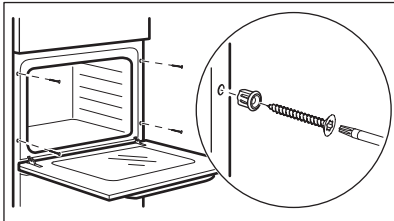

4. PRODUCT DESCRIPTION

4.1 General overview

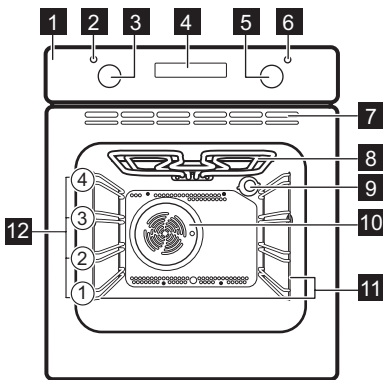

- 1** Control panel
- 2** Power lamp / symbol
- 3** Knob for the heating functions
- 4** Display
- 5** Control knob (for the temperature)
- 6** Temperature indicator / symbol
- 7** Air vents for the cooling fan
- 8** Heating element
- 9** Lamp
- 10** Fan
- 11** Shelf support, removable
- 12** Shelf positions

4.2 Accessories

- **Wire shelf**
For cookware, cake tins, roasts.

- **Baking tray**
For cakes and biscuits.

5. CONTROL PANEL

5.1 Sensor fields / Buttons

—	To set the time.
	To set a clock function.
+	To set the time.

5.2 Display

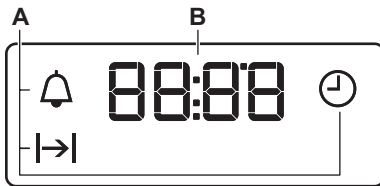

- A. Clock functions
- B. Timer

6. BEFORE FIRST USE



WARNING!
Refer to Safety chapters.

6.1 Before first use

The oven can emit an odour and smoke during preheating. Make sure that the room is ventilated.







Step 1



Step 2



Step 3

Set the clock	Clean the oven	Preheat the empty oven
<ol style="list-style-type: none"> 1.  - press to set the time. After approximately 5 sec., the flashing stops and the display shows the time. 	<ol style="list-style-type: none"> 1. Remove all accessories and removable shelf supports from the oven. 2. Clean the oven and the accessories with a soft cloth, warm water and a mild detergent. 	<ol style="list-style-type: none"> 1. Set the maximum temperature for the function: . Time: 1 h. 2. Set the maximum temperature for the function: . Time: 15 min. 3. Set the maximum temperature for the function: . Time: 15 min.
<p>Turn off the oven and wait until it is cold. Place the accessories and the removable shelf supports in the oven.</p>		

7. DAILY USE



WARNING!

Refer to Safety chapters.

7.1 How to set: Heating function

Step 1 Turn the knob for the heating functions to select a heating function.

Step 2 Turn the control knob to select the temperature.

Step 3 When the cooking ends, turn the knobs to the off position to turn off the oven.

7.2 Heating functions

Heating function	Application
 Off position	The oven is off.
 Light	To turn on the lamp.
 True Fan Cooking	To bake on up to two shelf positions at the same time and to dry food. Set the temperature 20 - 40 °C lower than for Conventional Cooking.
 Moist Fan Baking	This function is designed to save energy during cooking. When you use this function, the temperature in the cavity may differ from the set temperature. The heating power may be reduced. For more information refer to "Daily Use" chapter, Notes on: Moist Fan Baking.
 Bottom Heat	To bake cakes with crispy bottom and to preserve food.

Heating function	Application
 Defrost	To defrost food (vegetables and fruit). The defrosting time depends on the amount and size of the frozen food.
 Grill	To grill thin pieces of food and to toast bread.
 Fast Grilling	To grill thin pieces of food in large quantities and to toast bread.
 Turbo Grilling	To roast large meat joints or poultry with bones on one shelf position. To make gratins and to brown.
 Conventional Cooking	To bake and roast food on one shelf position.

7.3 Notes on: Moist Fan Baking



This function was used to comply with the energy efficiency class and ecodesign requirements according to EU 65/2014 and EU 66/2014. Tests according to EN 60350-1.

The oven door should be closed during cooking so that the function is not interrupted and the oven operates with the highest energy efficiency possible.

For the cooking instructions refer to "Hints and tips" chapter, Moist Fan Baking. For general energy saving recommendations refer to "Energy Efficiency" chapter, Energy Saving.

8. CLOCK FUNCTIONS



8.1 Clock functions

Clock function	Application
 Time of Day	To set, change or check the time of day.
 Duration	To set how long the oven works.
 Minute Minder	To set a countdown. This function has no effect on the operation of the oven. You can set this function at any time, also when the oven is off.



8.2 How to set: Clock functions



How to set: Time of Day

 - flashes when you connect the oven to the electrical supply, when there was a power cut or when the timer is not set.

 ,  - press to set the time.
After approximately 5 sec., the flashing stops and the display shows the time.

How to change: Time of Day





Step 1  - press repeatedly to change the time of day.  - starts to flash.

Step 2  ,  - press to set the time.
After approximately 5 sec., the flashing stops and the display shows the time.

How to set: Duration

Step 1 Set an oven function and the temperature.

Step 2  - press repeatedly.  - starts to flash.

Step 3  ,  - press to set the duration.
The display shows: .
 - flashes when the set time ends. The signal sounds and the oven turns off.

Step 4 Press any button to stop the signal.

Step 5 Turn the knobs to the off position.

How to set: Minute Minder

Step 1  - press repeatedly.  - starts to flash.

How to set: Minute Minder

Step 2  - press to set the time.
The function starts automatically after 5 sec.
When the set time ends, the signal sounds.

Step 3 Press any button to stop the signal.

Step 4 Turn the knobs to the off position.

How to cancel: Clock functions

Step 1  - press repeatedly until the clock function symbol starts to flash.

Step 2 Press and hold: .
The clock function turns off after few seconds.

9. USING THE ACCESSORIES



WARNING!

Refer to Safety chapters.

9.1 Inserting accessories

A small indentation at the top increases safety. The indentations are also anti-tip

Wire shelf:

Push the shelf between the guide bars of the shelf support and make sure that the feet point down.

devices. The high rim around the shelf prevents cookware from slipping of the shelf.

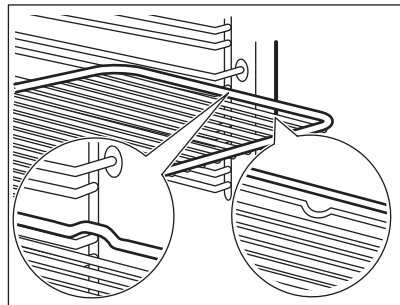

Baking tray:

Push the tray between the guide bars of the shelf support.

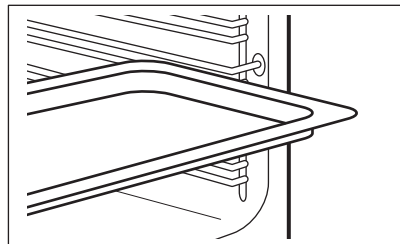

Wire shelf, Baking tray:

Push the tray between the guide bars of the shelf support and the wire shelf on the guide bars above.

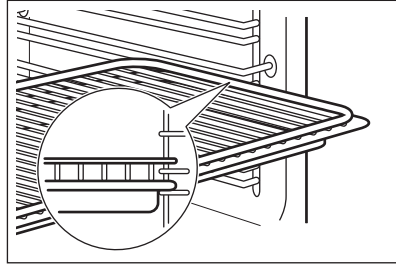

10. ADDITIONAL FUNCTIONS

10.1 Cooling fan

When the oven operates, the cooling fan turns on automatically to keep the surfaces of the oven cool. If you turn off the oven, the cooling fan can continue to operate until the oven cools down.

10.2 Safety thermostat

Incorrect operation of the oven or defective components can cause dangerous overheating. To prevent this, the oven has a safety thermostat which interrupts the power supply. The oven turns on again automatically when the temperature drops.

11. HINTS AND TIPS



Refer to Safety chapters.

11.1 Cooking recommendations

The oven has four shelf positions.

Count the shelf positions from the bottom of the oven floor.

Your oven may bake or roast differently to the oven you had before. The below tables provide you with the standard settings for temperature, cooking time and shelf position.

If you cannot find the settings for a special recipe, look for the similar one.

The oven has a special system which circulates the air and constantly recycles the steam. With this system you can cook in a steamy environment and keep the food soft inside and crusty outside. It decreases the cooking time and energy consumption.

Baking cakes

Do not open the oven door before 3/4 of the set cooking time is up.

If you use two baking trays at the same time, keep one empty level between them.

Cooking meat and fish

Leave the meat for approximately 15 minutes before carving so that the juice does not seep out.







To prevent too much smoke in the oven during roasting, add some water into the deep pan. To prevent the smoke condensation, add water each time after it dries up.

Cooking times







Cooking times depend on the type of food, its consistency, and volume.







Initially, monitor the performance when you cook. Find the best settings (heat setting, cooking time, etc.) for your cookware, recipes and quantities when you use this appliance.

11.2 Baking and roasting







 CAKES	Conventional Cook- ing		True Fan Cooking		 (min)	
	 (°C)		 (°C)			
Whisked recipes	170	2	160	2 (1 and 3)	45 - 60	Cake mould
Shortbread dough	170	2	160	2 (1 and 3)	24 - 34	Cake mould
Buttermilk cheese- cake	170	1	160	2	60 - 80	Cake mould, Ø 26 cm
Strudel	175	2	150	2	60 - 80	Baking tray
Jam tart	170	2	160	2	30 - 40	Cake mould, Ø 26 cm
Fruit cake	170	2	155	2	60 - 70	Cake mould, Ø 26 cm
Christmas cake / Rich fruit cake	170	2	160	2	50 - 60	Cake mould, Ø 20 cm
Plum cake, preheat the empty oven	170	2	160	2	50 - 60	Bread tin
Biscuits, preheat the empty oven	150	3	150	3	20 - 30	Baking tray
Meringues	100	3	100	3	90 - 120	Baking tray
Buns, preheat the empty oven	190	3	180	3	15 - 20	Baking tray
Choux pastry, pre- heat the empty oven	190	3	180	3	25 - 35	Baking tray
Plate tarts	180	3	170	2	45 - 70	Cake mould, Ø 20 cm
Victoria sandwich	180	1 or 2	170	2	40 - 55	Cake mould, Ø 20 cm

Preheat the empty oven.

 BREAD AND PIZZA	Conventional Cook- ing		True Fan Cooking		 (min)	
	 (°C)		 (°C)			
White bread, 1 - 2 pieces, 0.5 kg each	190	1	190	1	60 - 70	-
Rye bread, preheating is not needed	190	1	180	1	30 - 45	Bread tin
Bread rolls, 6 - 8 rolls	190	2	180	2 (1 and 3)	25 - 40	Baking tray





 BREAD AND PIZZA	Conventional Cooking		True Fan Cooking		 (min)	
	 (°C)		 (°C)			
Pizza	190	1	190	1	20 - 30	Deep pan
Scones	200	3	190	2	10 - 20	Baking tray







Use the cake mould.







 FLANS	Conventional Cooking		True Fan Cooking		 (min)
	 (°C)		 (°C)		
Pasta flan	180	2	180	2	40 - 50
Vegetable flan	200	2	175	2	45 - 60
Quiches	190	1	190	1	40 - 50
Lasagne	200	2	200	2	25 - 40
Cannelloni	200	2	190	2	25 - 40
Yorkshire pudding, 6 pudding moulds, preheat the empty oven	220	2	210	2	20 - 30

Use the second shelf position.

Use the wire shelf.

 MEAT	Conventional Cooking		True Fan Cooking		 (min)
	 (°C)		 (°C)		
Beef	200		190		50 - 70
Pork	180		180		90 - 120
Veal	190		175		90 - 120
English roast beef, rare	210		200		44 - 50
English roast beef, medium	210		200		51 - 55
English roast beef, well done	210		200		55 - 60

 MEAT	Conventional Cooking		True Fan Cooking		 (min)
	 (°C)		 (°C)		
Pork shoulder, with rind	180	2	170	2	120 - 150
Pork shin, 2 pieces	180	2	160	2	100 - 120
Leg of lamb	190	2	190	2	110 - 130
Whole chicken	200	2	200	2	70 - 85
Whole turkey	180	1	160	1	210 - 240
Whole duck	175	2	160	2	120 - 150
Whole goose	175	1	160	1	150 - 200
Rabbit, cut in pieces	190	2	175	2	60 - 80
Hare, cut in pieces	190	2	175	2	150 - 200
Whole pheasant	190	2	175	2	90 - 120





 FISH	Conventional Cooking		True Fan Cooking		 (min)
	 (°C)		 (°C)		
Trout / Sea bream, 3 - 4 fish	190	2	175	2 (1 and 3)	40 - 55
Tuna / Salmon, 4 - 6 fillets	190	2	175	2 (1 and 3)	35 - 60





11.3 Grill

Preheat the empty oven.

Use the third shelf position.

Set the temperature to 250 °C.

 GRILL	 (kg)	 (min)	 (min)
		1st side	2nd side
Fillet steaks, 4 pieces	0.8	12 - 15	12 - 14
Beef steak, 4 pieces	0.6	10 - 12	6 - 8
Sausages, 8	-	12 - 15	10 - 12
Pork chops, 4 pieces	0.6	12 - 16	12 - 14
Chicken, half, 2	1	30 - 35	25 - 30
Kebabs, 4	-	10 - 15	10 - 12
Chicken breast, 4 pieces	0.4	12 - 15	12 - 14



 GRILL	 (kg)	 (min) 1st side	 (min) 2nd side
Burgers, 6	0.6	20 - 30	-
Fish fillet, 4 pieces	0.4	12 - 14	10 - 12
Toasted sandwiches, 4 - 6	-	5 - 7	-
Toast, 4 - 6	-	2 - 4	2 - 3

11.4 Turbo Grilling





Preheat the empty oven.





Set the temperature to 200 °C.

Use the third shelf position.

	 (kg)	 (min)	1st side	2nd side
Rolled joint, turkey	1		30 - 40	20 - 30
Chicken, half, 2	1		25 - 30	20 - 30
Chicken drumsticks, 6 pieces	-		15 - 20	15 - 18
Quail, 4 pieces	0.5		25 - 30	20 - 25
Vegetables au gratin	-		20 - 25	-
Scallops	-		15 - 20	-
Mackerel, 2 - 4	-		15 - 20	10 - 15
Fish slices, 4 - 6	0.8		12 - 15	8 - 10

11.5 Defrost

	 (kg)	 Defrosting time (min)	 Further defrosting time (min)	
Chicken	1	100 - 140	20 - 30	Place chicken on an up-turned saucer placed on a large plate. Turn halfway through.
Meat	1	100 - 140	20 - 30	Turn halfway through.
	0.5	90 - 120		

	 (kg)	 Defrosting time (min)	 Further defrosting time (min)	
Cream	2 x 0.2	80 - 100	10 - 15	Cream can also be whipped when still slightly frozen in places.
Trout	0.15	25 - 35	10 - 15	-
Strawberries	0.3	30 - 40	10 - 20	-
Butter	0.25	30 - 40	10 - 15	-
Gateau	1.4	60	60	-

11.6 Moist Fan Baking - recommended accessories

Use the dark and non-reflective tins and containers. They have better heat absorption than the light colour and reflective dishes.



Pizza pan

Dark, non-reflective
28 cm diameter

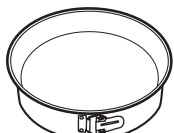

Baking dish

Dark, non-reflective
26 cm diameter



Ramekins

Ceramic
8 cm diameter, 5
cm height













Flan base tin

Dark, non-reflective
28 cm diameter

11.7 Moist Fan Baking







For the best results follow suggestions listed in the table below.







		 (°C)		 (min)
Sweet rolls, 12 pieces	baking tray or dripping pan	180	2	35 - 40
Rolls, 9 pieces	baking tray or dripping pan	180	2	35 - 40
Pizza, frozen, 0.35 kg	wire shelf	220	2	35 - 40
Swiss roll	baking tray or dripping pan	170	2	30 - 40
Brownie	baking tray or dripping pan	180	2	30 - 40
Soufflé, 6 pieces	ceramic ramekins on wire shelf	200	3	30 - 40
Sponge flan base	flan base tin on wire shelf	170	2	20 - 30
Victoria sandwich	baking dish on wire shelf	170	2	35 - 45

		 (°C)		 (min)
Poached fish, 0.3 kg	baking tray or dripping pan	180	3	35 - 45
Whole fish, 0.2 kg	baking tray or dripping pan	180	3	35 - 45
Fish fillet, 0.3 kg	pizza pan on wire shelf	180	3	35 - 45
Poached meat, 0.25 kg	baking tray or dripping pan	200	3	40 - 50
Shashlik, 0.5 kg	baking tray or dripping pan	200	3	25 - 35
Cookies, 16 pieces	baking tray or dripping pan	180	2	20 - 30
Macaroons, 20 pieces	baking tray or dripping pan	180	2	40 - 45
Muffins, 12 pieces	baking tray or dripping pan	170	2	30 - 40
Savory pastry, 16 pieces	baking tray or dripping pan	170	2	35 - 45
Short crust biscuits, 20 pieces	baking tray or dripping pan	150	2	40 - 50
Tartlets, 8 pieces	baking tray or dripping pan	170	2	20 - 30
Vegetables, poached, 0.4 kg	baking tray or dripping pan	180	3	35 - 40
Vegetarian omelette	pizza pan on wire shelf	200	3	30 - 45
Mediterranean vegetables, 0.7 kg	baking tray or dripping pan	180	4	35 - 40

11.8 Information for test institutes

Tests according to IEC 60350-1.

				 (°C)	 (min)	
Small cakes, 20 per tray	Conventional Cooking	Baking tray	3	170	20 - 30	-
Apple pie, 2 tins Ø20 cm	Conventional Cooking	Wire shelf	1	170	80 - 120	-
Sponge cake, cake mould Ø26 cm	Conventional Cooking	Wire shelf	2	170	35 - 45	-
Short bread	Conventional Cooking	Baking tray	3	150	20 - 35	Preheat the oven for 10 minutes.
Toast, 4 - 6 pieces	Grill	Wire shelf	3	max.	2 - 4 minutes first side; 2 - 3 minutes second side	Preheat the oven for 3 minutes.

				 (°C)	 (min)	
Beef burger, 6 pieces, 0.6 kg	Grill	Wire shelf and dripping pan	3	max.	20 - 30	Put the wire shelf on the third level and the dripping pan on the second level of the oven. Turn the food halfway through the cooking time. Preheat the oven for 3 minutes.

12. CARE AND CLEANING



WARNING!

Refer to Safety chapters.

12.1 Notes on cleaning



Cleaning Agents

Clean the front of the oven with a soft cloth with warm water and a mild detergent. Clean and check the door gasket around the frame of the cavity.

Use a cleaning solution to clean metal surfaces.

Clean stains with a mild detergent.



Everyday Use

Clean the cavity after each use. Fat accumulation or other residue may cause fire.

Moisture can condense in the oven or on the door glass panels. To decrease the condensation, let the oven work for 10 minutes before cooking. Do not store the food in the oven for longer than 20 minutes. Dry the cavity with a soft cloth after each use.



Accessories

Clean all accessories after each use and let them dry. Use a soft cloth with warm water and a mild detergent. Do not clean the accessories in a dishwasher.

Do not clean the non-stick accessories using abrasive cleaner or sharp-edged objects.

12.2 How to remove: Shelf supports

Remove the shelf supports to clean the oven.

Step 1 Turn off the oven and wait until it is cold.

Step 2 Pull the front of the shelf support away from the side wall.

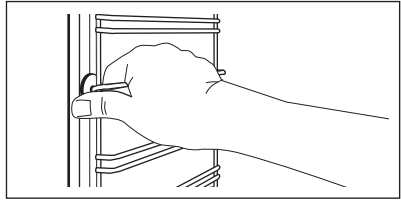

Step 3 Pull the rear end of the shelf support away from the side wall and remove it.

Step 4 Install the shelf supports in the opposite sequence.

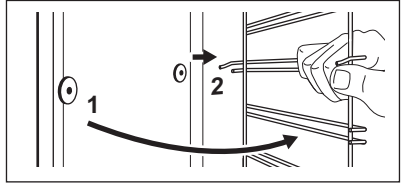

12.3 How to remove and install: Door

The oven door has two glass panels. You can remove the oven door and the internal glass panel to clean it. Read the whole "Removing and installing door" instruction before you remove the glass panels.



CAUTION!

Do not use the oven without the glass panels.

Step 1 Open the door fully and hold both hinges.

Step 2

Lift and turn the levers fully on both hinges.

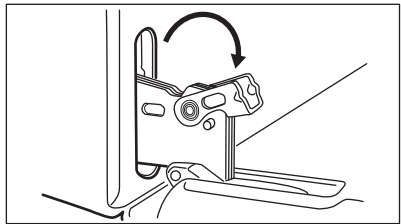
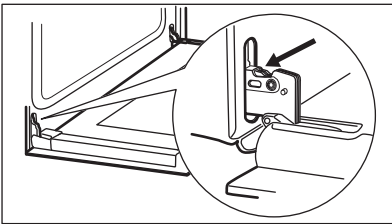

Step 3 Close the oven door halfway to the first opening position. Then lift and pull forward and remove the door from its seat.

Step 4

Put the door on a soft cloth on a stable surface and release the locking system to remove the internal glass panel.

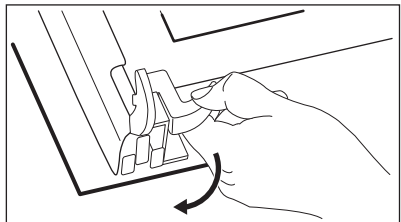
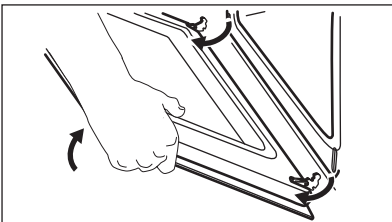

Step 5 Turn the fasteners by 90° and remove them from their seats.

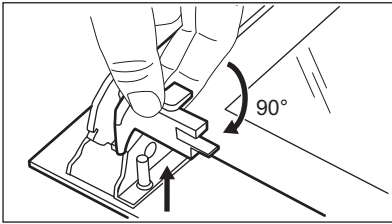

Step 6 First lift carefully and then remove the glass panel.

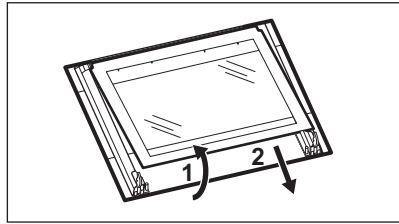

Step 7 Clean the glass panels with water and soap. Dry the glass panels carefully. Do not clean the glass panels in the dishwasher.

Step 8 After cleaning, install the glass panel and the oven door.

When installed correctly the door trim clicks. Make sure that you install the internal glass panel in the seats correctly.

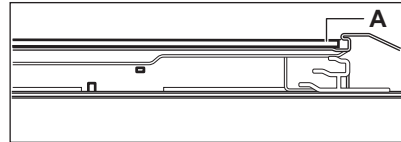

12.4 How to replace: Lamp



WARNING!

Risk of electric shock.
The lamp can be hot.

Before you replace the lamp:

Step 1	Step 2	Step 3
Turn off the oven. Wait until the oven is cold.	Disconnect the oven from the mains.	Put a cloth on the bottom of the cavity.

Back lamp

Step 1 Turn the glass cover to remove it.

Step 2 Clean the glass cover.

Step 3 Replace the lamp with a suitable 300 °C heat-resistant lamp.

Step 4 Install the glass cover.

13. TROUBLESHOOTING



WARNING!

Refer to Safety chapters.

13.1 What to do if...

In any cases not included in this table please contact with an Authorised Service Centre.

Problem	Check if...
The oven does not heat up.	The fuse is blown.
The door gasket is damaged.	Do not use the oven. Contact an Authorised Service Centre.
The display shows "12.00".	There was a power cut. Set the time of day.

Problem	Check if...
The lamp does not work.	The lamp is burnt out.

13.2 Service data

If you cannot find a solution to the problem yourself, contact your dealer or an Authorised Service Centre.

The necessary data for the service centre is on the rating plate. The rating plate is on the front frame of the oven cavity. Do not remove the rating plate from the oven cavity.

We recommend that you write the data here:

Model (MOD.)

Product number (PNC)

Serial number (S.N.)

14. ENERGY EFFICIENCY

14.1 Product Information and Product Information Sheet*

Supplier's name	Zanussi	
Model identification	ZOHEE2X1 944068087 ZOHIE2X1 944068089	
Energy Efficiency Index	94.9	
Energy efficiency class	A	
Energy consumption with a standard load, conventional mode	0.83 kWh/cycle	
Energy consumption with a standard load, fan-forced mode	0.75 kWh/cycle	
Number of cavities	1	
Heat source	Electricity	
Volume	57 l	
Type of oven	Built-In Oven	
Mass	ZOHEE2X1	28.6 kg
	ZOHIE2X1	28.6 kg

* For European Union according to EU Regulations 65/2014 and 66/2014.

For Republic of Belarus according to STB 2478-2017, Appendix G; STB 2477-2017, Annexes A and B.

For Ukraine according to 568/32020.

Energy efficiency class is not applicable for Russia.

EN 60350-1 - Household electric cooking appliances - Part 1: Ranges, ovens, steam ovens and grills - Methods for measuring performance.

14.2 Energy saving



The oven has features which help you save energy during everyday cooking.

Make sure that the oven door is closed when the oven operates. Do not open the oven door too often during cooking. Keep the door gasket clean and make sure it is well fixed in its position.

Use metal cookware to improve energy saving.

When possible, do not preheat the oven before cooking.

Keep breaks between baking as short as possible when you prepare a few dishes at one time.

Cooking with fan

When possible, use the cooking functions with fan to save energy.

Residual heat

When the cooking duration is longer than 30 min, reduce the oven temperature to minimum 3 - 10 min before the end of cooking. The residual heat inside the oven will continue to cook.

Use the residual heat to warm up other dishes.

Keep food warm

Choose the lowest possible temperature setting to use residual heat and keep a meal warm.

Moist Fan Baking

Function designed to save energy during cooking.

15. ENVIRONMENTAL CONCERNS

Recycle materials with the symbol . Put the packaging in relevant containers to recycle it. Help protect the environment and human health by recycling waste of electrical and electronic appliances. Do not dispose of

appliances marked with the symbol  with the household waste. Return the product to your local recycling facility or contact your municipal office.

VISITEZ NOTRE SITE WEB POUR :



Obtenir des conseils d'utilisation, des brochures, un dépanneur, des informations sur le service et les réparations :
www.zanussi.com/support

Sous réserve de modifications.

TABLE DES MATIÈRES

1. INFORMATION SUR LA SÉCURITÉ.....	48
2. CONSIGNES DE SÉCURITÉ.....	50
3. INSTALLATION.....	53
4. DESCRIPTION DE L'APPAREIL.....	54
5. BANDEAU DE COMMANDE.....	54
6. AVANT LA PREMIÈRE UTILISATION.....	55
7. UTILISATION QUOTIDIENNE.....	55
8. FONCTIONS DE L'HORLOGE.....	56
9. UTILISATION DES ACCESSOIRES.....	58
10. FONCTIONS SUPPLÉMENTAIRES.....	59
11. CONSEILS ET ASTUCES.....	59
12. ENTRETIEN ET NETTOYAGE.....	66
13. DÉPANNAGE.....	69
14. RENDEMENT ÉNERGÉTIQUE.....	70

1. ⚠ INFORMATION SUR LA SÉCURITÉ

Avant d'installer et d'utiliser cet appareil, lisez soigneusement les instructions fournies. Le fabricant ne pourra être tenu pour responsable des blessures et dégâts résultant d'une mauvaise installation ou utilisation. Conservez toujours les instructions dans un lieu sûr et accessible pour vous y référer ultérieurement.

1.1 Sécurité des enfants et des personnes vulnérables

- Cet appareil peut être utilisé par des enfants âgés d'au moins 8 ans et par des personnes ayant des capacités physiques, sensorielles ou mentales réduites ou dénuées d'expérience ou de connaissance, s'ils sont correctement surveillés ou si des instructions relatives à l'utilisation de l'appareil en toute sécurité leur ont été données et s'ils comprennent les risques encourus. Les enfants de moins

de 8 ans et les personnes ayant un handicap très important et complexe doivent être tenus à l'écart de l'appareil, à moins d'être surveillés en permanence.

- Ne laissez pas les enfants jouer avec l'appareil.
- Ne laissez pas les emballages à la portée des enfants et jetez-les convenablement.
- **AVERTISSEMENT** : Tenez les enfants et les animaux éloignés de l'appareil lorsqu'il est en cours de fonctionnement ou lorsqu'il refroidit. Les parties accessibles deviennent chaudes en cours d'utilisation.
- Si l'appareil est équipé d'un dispositif de sécurité enfants, nous vous recommandons de l'activer.
- Le nettoyage et l'entretien ne doivent pas être effectués par des enfants sans surveillance.

1.2 Consignes générales de sécurité

- L'appareil doit être installé et le câble remplacé uniquement par un professionnel qualifié.
- **AVERTISSEMENT** : L'appareil et ses parties accessibles deviennent chauds pendant son fonctionnement. Veillez à ne pas toucher les éléments chauffants.
- Utilisez toujours des gants de cuisine pour retirer ou enfourner des accessoires ou des plats allant au four.
- Avant d'effectuer une opération de maintenance, débranchez l'appareil de la prise secteur.
- **AVERTISSEMENT** : Assurez-vous que l'appareil est éteint et débranché avant de remplacer l'éclairage afin d'éviter tout risque de choc électrique.
- N'utilisez pas l'appareil avant de l'avoir installé dans la structure encastrée.
- N'utilisez pas de nettoyeur vapeur pour nettoyer l'appareil.
- N'utilisez pas de produits abrasifs ni de racloirs pointus en métal pour nettoyer la porte en verre car ils peuvent rayer sa surface, ce qui peut briser le verre.
- Si le câble d'alimentation est endommagé, il doit être remplacé par le fabricant, un service de maintenance agréé ou un technicien qualifié afin d'éviter tout danger lié à l'électricité.

- Pour retirer les supports de grille, tirez d'abord sur l'avant de ceux-ci, puis sur l'arrière, pour les écarter des parois extérieures. Réinstallez les supports de grille en répétant cette procédure dans l'ordre inverse.

2. CONSIGNES DE SÉCURITÉ

2.1 Installation



AVERTISSEMENT!

L'appareil doit être installé uniquement par un professionnel qualifié.

- Retirez l'intégralité de l'emballage.
- N'installez pas et ne branchez pas un appareil endommagé.
- Suivez scrupuleusement les instructions d'installation fournies avec l'appareil.
- Soyez toujours vigilants lorsque vous déplacez l'appareil car il est lourd. Utilisez toujours des gants de sécurité et des chaussures fermées.
- Ne tirez jamais l'appareil par la poignée.
- Installez l'appareil dans un lieu sûr et adapté répondant aux exigences d'installation.
- Respectez l'espacement minimal requis par rapport aux autres appareils et éléments.
- Avant de monter l'appareil, vérifiez si la porte du four s'ouvre sans retenue.
- Cet appareil est équipé d'un système de refroidissement électrique. Il doit être utilisé lorsque l'appareil est raccordé à une prise secteur.

Hauteur minimale du meuble (Hauteur minimale du meuble sous le plan de travail)	590 (600) mm
---	--------------

Largeur du meuble	560 mm
-------------------	--------

Profondeur du meuble	550 (550) mm
----------------------	--------------

Hauteur de l'avant de l'appareil	598 mm
----------------------------------	--------

Hauteur de l'arrière de l'appareil	579 mm
------------------------------------	--------

Largeur de l'avant de l'appareil	594 mm
----------------------------------	--------

Largeur de l'arrière de l'appareil	558 mm
Profondeur de l'appareil	561 mm
Profondeur d'encastrement de l'appareil	540 mm
Profondeur avec porte ouverte	1007 mm
Dimensions minimales de l'ouverture de ventilation. Ouverture placée sur la partie inférieure de la face arrière	560x20 mm
Longueur du câble d'alimentation secteur. Le câble est placé dans le coin droit de la face arrière	1100 mm
Vis de montage	4x25 mm

2.2 Raccordement électrique



AVERTISSEMENT!

Risque d'incendie ou d'électrocution.

- Tous les raccordements électriques doivent être effectués par un électricien qualifié.
- L'appareil doit être relié à la terre.
- Assurez-vous que les paramètres figurant sur la plaque signalétique correspondent aux données électriques nominale de l'alimentation secteur.
- Utilisez toujours une prise de courant de sécurité correctement installée.
- N'utilisez pas d'adaptateurs multiprise et de rallonges.
- Veillez à ne pas endommager la fiche secteur ni le câble d'alimentation. Le remplacement du câble d'alimentation de l'appareil doit être effectué par notre service après-vente agréé.
- Ne laissez pas les câbles d'alimentation entrer en contact ou s'approcher de la

porte de l'appareil ou de la niche d'encastrement sous l'appareil, particulièrement lorsqu'il est en marche ou que la porte est chaude.

- La protection contre les chocs des parties sous tension et isolées doit être fixée de telle manière qu'elle ne puisse pas être enlevée sans outils.
- Ne branchez la fiche secteur dans la prise secteur qu'à la fin de l'installation. Assurez-vous que la prise secteur est accessible après l'installation.
- Si la prise secteur est détachée, ne branchez pas la fiche secteur.
- Ne tirez pas sur le câble secteur pour débrancher l'appareil. Tirez toujours sur la fiche de la prise secteur.
- N'utilisez que des systèmes d'isolation appropriés : des coupe-circuits, des fusibles (les fusibles à visser doivent être retirés du support), un disjoncteur différentiel et des contacteurs.
- L'installation électrique doit comporter un dispositif d'isolation qui vous permet de déconnecter l'appareil du secteur à tous les pôles. Le dispositif d'isolement doit avoir une largeur d'ouverture de contact de 3 mm minimum.
- Cet appareil est fourni avec une fiche d'alimentation et un câble d'alimentation.

Types de câbles compatibles pour l'installation ou le remplacement pour l'Europe :

H07 RN-F, H05 RN-F, H05 RRF, H05 VV-F, H05 V2V2-F (T90), H05 BB-F

Pour la section du câble, consultez la puissance totale sur la plaque signalétique. Vous pouvez également consulter le tableau :

Puissance totale (W)	Section du câble (mm ²)
maximum 1380	3 x 0.75
maximum 2300	3 x 1
maximum 3680	3 x 1.5

Le fil de masse (fil jaune/vert) doit faire 2 cm de plus que les fils de phase et neutre (fils bleu et marron).



2.3 Utilisation



AVERTISSEMENT!

Risque de blessures, de brûlures, d'électrocution ou d'explosion.

- Cet appareil est exclusivement destiné à une utilisation domestique.
- Ne modifiez pas les caractéristiques de cet appareil.
- Assurez-vous que les orifices de ventilation ne sont pas bouchés.
- Ne laissez jamais l'appareil sans surveillance pendant son fonctionnement.
- Éteignez l'appareil après chaque utilisation.
- Soyez prudent lors de l'ouverture de la porte de l'appareil lorsque celui-ci est en fonctionnement. De l'air brûlant peut s'en échapper.
- N'utilisez jamais cet appareil avec les mains mouillées ou lorsqu'il est en contact avec de l'eau.
- N'exercez jamais de pression sur la porte ouverte.
- N'utilisez jamais l'appareil comme plan de travail ou comme plan de stockage.
- Ouvrez prudemment la porte de l'appareil. Si vous utilisez des ingrédients contenant de l'alcool, un mélange d'alcool et d'air facilement inflammable peut éventuellement se former.
- Ne laissez pas des étincelles ou des flammes nues entrer en contact avec l'appareil lorsque vous ouvrez la porte.
- Ne placez pas de produits inflammables ou d'éléments imbibés de produits inflammables à l'intérieur ou à proximité de l'appareil, ni sur celui-ci.



AVERTISSEMENT!

Risque d'endommagement de l'appareil.

- Pour éviter tout endommagement ou décoloration de l'émail :
 - ne posez pas de plats allant au four ni aucun autre objet directement sur le fond de l'appareil.

- ne placez jamais de feuilles d'aluminium directement sur le fond de la cavité de l'appareil.
- ne versez jamais d'eau directement dans l'appareil lorsqu'il est chaud.
- une fois la cuisson terminée, ne laissez jamais d'aliments ou de plats humides à l'intérieur de l'appareil.
- faites attention lorsque vous retirez ou remettez en place les accessoires.
- La décoloration de l'émail ou de l'acier inoxydable est sans effet sur les performances de l'appareil.
- Utilisez un plat à rôtir pour obtenir des gâteaux moelleux. Les jus de fruits causent des taches qui peuvent être permanentes.
- Cet appareil est exclusivement destiné à un usage culinaire. Ne l'utilisez pas pour des usages autres que celui pour lequel il a été conçu, à des fins de chauffage par exemple.
- La porte du four doit toujours être fermée pendant la cuisson.
- Si l'appareil est installé derrière la paroi d'un meuble (par ex. une porte), veuillez à ce que la porte ne soit jamais fermée lorsque l'appareil fonctionne. La chaleur et l'humidité peuvent s'accumuler derrière la porte fermée du meuble et provoquer d'importants dégâts sur l'appareil, le meuble ou le sol. Ne fermez pas la paroi du meuble tant que l'appareil n'a pas complètement refroidi.

2.4 Entretien et Nettoyage



AVERTISSEMENT!

Risque de blessure, d'incendie ou de dommages matériels sur l'appareil.

- Avant toute opération d'entretien, éteignez l'appareil et débranchez la fiche de la prise secteur.
- Vérifiez que l'appareil est froid. Les panneaux de verre risquent de se briser.
- Remplacez immédiatement les vitres de la porte si elles sont endommagées. Contactez le service après-vente agréé.
- Soyez prudent lorsque vous retirez la porte de l'appareil. La porte est lourde !

- Nettoyez régulièrement l'appareil afin de maintenir le revêtement en bon état.
- Nettoyez l'appareil avec un chiffon doux humide. Utilisez uniquement des produits de lavage neutres. N'utilisez pas de produits abrasifs, de tampons à récurer, de solvants ni d'objets métalliques.
- Si vous utilisez un spray pour four, suivez les consignes de sécurité figurant sur son emballage.

2.5 Éclairage intérieur



AVERTISSEMENT!

Risque d'électrocution !

- Concernant la/les lampe(s) à l'intérieur de ce produit et les lampes de rechange vendues séparément : Ces lampes sont conçues pour résister à des conditions physiques extrêmes dans les appareils électroménagers, telles que la température, les vibrations, l'humidité, ou sont conçues pour signaler des informations sur le statut opérationnel de l'appareil. Elles ne sont pas destinées à être utilisées dans d'autres applications et ne conviennent pas à l'éclairage des pièces d'un logement.
- Utilisez uniquement des ampoules ayant les mêmes spécifications.

2.6 Maintenance

- Pour réparer l'appareil, contactez un service après-vente agréé.
- Utilisez exclusivement des pièces d'origine.

2.7 Mise au rebut



AVERTISSEMENT!

Risque de blessure ou d'asphyxie.

- Débranchez l'appareil de l'alimentation électrique.
- Coupez le câble d'alimentation au ras de l'appareil et mettez-le au rebut.
- Retirez le dispositif de verrouillage du hublot pour empêcher les enfants et les animaux de s'enfermer dans l'appareil.

3. INSTALLATION



AVERTISSEMENT!
Reportez-vous aux chapitres
concernant la sécurité.

3.1 Encastrement

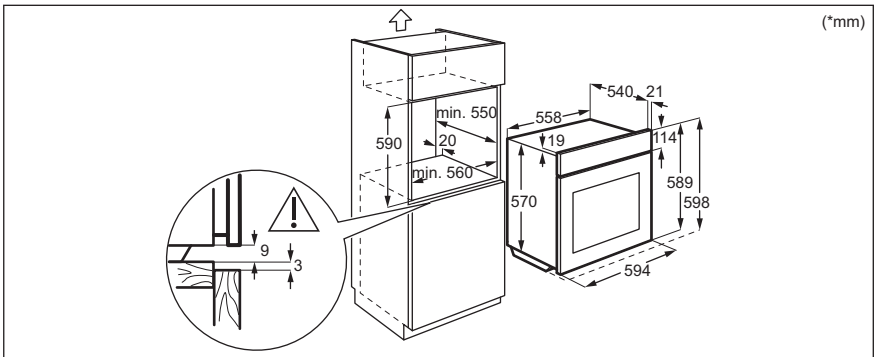
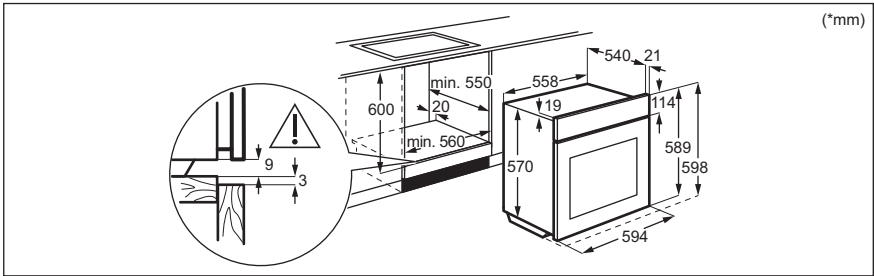

3.2 Fixation du four au meuble

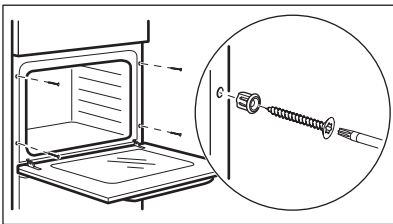

4. DESCRIPTION DE L'APPAREIL

4.1 Présentation générale

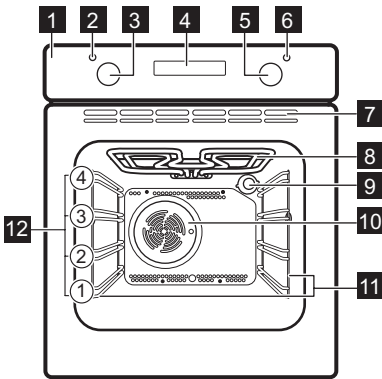

- 1 Bandeau de commande
- 2 Voyant / symbole de mise sous tension
- 3 Manette de sélection des modes de cuisson
- 4 Affichage
- 5 Thermostat
- 6 Indicateur / symbole de température
- 7 Orifices d'aération du ventilateur de refroidissement
- 8 Élément chauffant
- 9 Éclairage
- 10 Ventilateur
- 11 Support de grille, amovible
- 12 Position des grilles

4.2 Accessoires

- **Grille métallique**
Pour les plats à rôti, à gratin et les moules à gâteau/pâtisserie.

- **Plateau de cuisson**
Pour les gâteaux et les biscuits.

5. BANDEAU DE COMMANDE

5.1 Touches sensibles

—	Pour régler l'heure.
⌚	Pour régler une fonction de l'horloge.
+	Pour régler l'heure.

5.2 Affichage

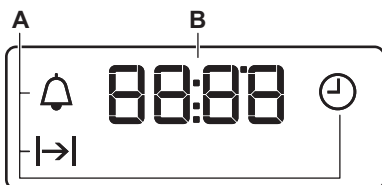

- A. Fonctions de l'horloge
- B. Minuteur

6. AVANT LA PREMIÈRE UTILISATION



AVERTISSEMENT!

Reportez-vous aux chapitres concernant la sécurité.

6.1 Avant la première utilisation

Une odeur et de la fumée peuvent s'échapper du four durant le préchauffage. Assurez-vous que la pièce est ventilée.



Étape 1



Étape 2



Étape 3

Réglez l'horloge.	Nettoyez le four	Préchauffez le four à vide
<p>1. - appuyez pour régler l'heure. Après environ 5 s, le symbole cesse de clignoter et l'heure s'affiche.</p>	<p>1. Retirez les supports de grille amovibles et tous les accessoires du four.</p> <p>2. Nettoyez le four et les accessoires avec un chiffon doux, de l'eau tiède et un détergent doux.</p>	<p>1. Réglez la température maximale pour la fonction : . Durée : 1 h.</p> <p>2. Réglez la température maximale pour la fonction : . Durée : 15'</p> <p>3. Réglez la température maximale pour la fonction : . Durée : 15'</p>
<p>Éteignez le four et attendez qu'il soit froid. Placez les accessoires et les supports de grille amovibles dans le four.</p>		

7. UTILISATION QUOTIDIENNE



AVERTISSEMENT!







Reportez-vous aux chapitres concernant la sécurité.

7.1 Comment régler : Mode de cuisson

Étape 1	Tournez la manette des modes de cuisson pour sélectionner un mode de cuisson.
Étape 2	Tournez la manette pour sélectionner la température.
Étape 3	Une fois la cuisson terminée, tournez les manettes sur la position Arrêt pour éteindre le four.

7.2 Modes de cuisson

Mode de cuisson	Application
 Position Arrêt	Le four est éteint.
 Eclairage four	Pour allumer l'éclairage.
 Chaleur tournante	Pour faire cuire sur 2 niveaux en même temps et pour déshydrater des aliments. Diminuez les températures du four de 20 à 40 °C par rapport à la Chauffage Haut/ Bas.

Mode de cuisson	Application
 Chaleur tournante humide	Cette fonction est conçue pour économiser de l'énergie en cours de cuisson. Lorsque vous utilisez cette fonction, la température à l'intérieur de la cavité peut différer de la température sélectionnée. La puissance peut être réduite. Pour plus d'informations, consultez le chapitre « Utilisation quotidienne », Remarques sur : Chaleur tournante humide.
 Cuisson de sole	Pour cuire des gâteaux à fond croustillant et pour stériliser des aliments.
 Décongélation	Pour décongeler des aliments (fruits et légumes). Le temps de décongélation dépend de la quantité et de l'épaisseur des aliments surgelés.
 Gril	Pour faire griller des aliments peu épais et du pain.
 Gril rapide	Pour faire griller des aliments peu épais en grandes quantités et pour faire griller du pain.
 Turbo gril	Pour rôtir de grosses pièces de viande ou de volaille avec os sur un seul niveau. Également pour gratiner et faire dorer.

Mode de cuisson	Application
 Chauffage Haut/ Bas	Pour cuire et rôtir des aliments sur un seul niveau.

7.3 Remarques sur : Chaleur tournante humide



Cette fonction était utilisée pour se conformer à la classe d'efficacité énergétique et aux exigences d'éco-conception selon les normes EU 65/2014 et EU 66/2014. Tests conformément à la norme EN 60350-1.

Pendant la cuisson, la porte du four doit rester fermée pour éviter d'interrompre la fonction et pour un fonctionnement avec la meilleure efficacité énergétique possible.

Pour obtenir des instructions de cuisson, reportez-vous au chapitre « Conseils », paragraphe Chaleur tournante humide. Pour obtenir des recommandations générales sur les économies d'énergie, consultez le chapitre « Efficacité énergétique, « Four - Économie d'énergie ».

8. FONCTIONS DE L'HORLOGE

8.1 Fonctions de l'horloge

Fonction de l'horloge	Utilisation
 Heure	Pour régler, changer ou vérifier l'heure.
 Durée	Pour régler la durée de fonctionnement du four.
 Minuteur	Pour régler la minuterie. Cette fonction est sans effet sur le fonctionnement du four. Vous pouvez régler cette fonction à tout moment, même quand le four est éteint.



8.2 Comment régler : Fonctions de l'horloge

Comment régler : Heure

 - clignote lorsque vous branchez le four à l'alimentation électrique, lorsqu'il y a eu une coupure de courant ou que le minuteur n'est pas réglé.

 - appuyez pour régler l'heure.
Après environ 5 s, le symbole cesse de clignoter et l'heure s'affiche.



Comment modifier : Heure



Étape 1  - appuyez à plusieurs reprises pour modifier l'heure actuelle.  - commence à clignoter.

Étape 2  - appuyez pour régler l'heure.
Après environ 5 s, le symbole cesse de clignoter et l'heure s'affiche.

Comment régler : Durée

Étape 1 Sélectionnez la fonction et la température du four.



Étape 2  - appuyez à plusieurs reprises.  - commence à clignoter.

Étape 3  - appuyez pour régler la durée.
L'affichage indique : .
 - clignote lorsque la durée définie est écoulée. Le signal sonore retentit et le four s'éteint.

Étape 4 Appuyez sur n'importe quelle touche pour arrêter le signal sonore.

Étape 5 Tournez la manette sur la position Arrêt.

Comment régler : Minuteur

Étape 1  - appuyez à plusieurs reprises.  - commence à clignoter.

Étape 2  - appuyez pour régler l'heure.
La fonction démarre automatiquement au bout de 5 s.
Lorsque la durée définie s'est écoulée, un signal sonore retentit.

Étape 3 Appuyez sur n'importe quelle touche pour arrêter le signal sonore.

Étape 4 Tournez la manette sur la position Arrêt.

Comment annuler : Fonctions de l'horloge

Étape 1  - appuyez plusieurs fois jusqu'à ce que le symbole de la fonction horloge se mette à clignoter.

Étape 2 Maintenez la touche .
La fonction horloge est désactivée au bout de quelques secondes.

9. UTILISATION DES ACCESSOIRES



AVERTISSEMENT!

Reportez-vous aux chapitres concernant la sécurité.

9.1 Insertion des accessoires

Une petite indentation sur le dessus apporte plus de sécurité. Les indentations sont

également des dispositifs anti-bascule. Le rebord élevé de la grille empêche les ustensiles de cuisine de glisser.

Grille métallique:

Poussez la grille entre les barres de guidage des supports de grille et assurez-vous que les pieds sont orientés vers le bas.

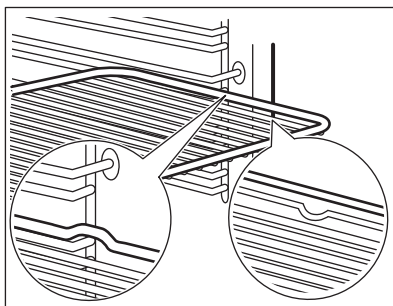

Plateau de cuisson:

Poussez le plateau entre les rails du support de grille.

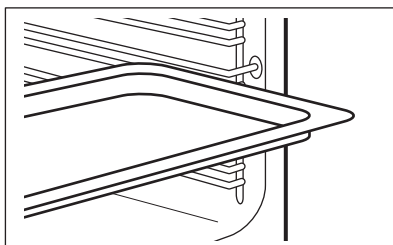

Grille métallique, Plateau de cuisson:

Poussez le plateau entre les rails du support de grille et glissez la grille métallique entre les rails se trouvant juste au-dessus.

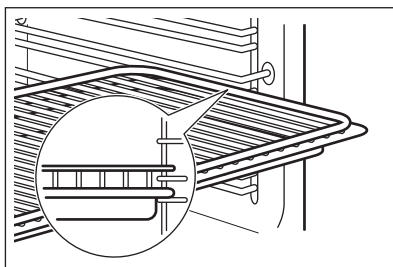

10. FONCTIONS SUPPLÉMENTAIRES

10.1 Ventilateur de refroidissement

Lorsque le four fonctionne, le ventilateur de refroidissement se met automatiquement en marche pour refroidir les surfaces du four. Si vous éteignez le four, le ventilateur de refroidissement continue à fonctionner jusqu'à ce que le four refroidisse.

10.2 Thermostat de sécurité

Un mauvais fonctionnement du four ou des composants défectueux peuvent causer une

surchauffe dangereuse. Pour éviter cela, le four dispose d'un thermostat de sécurité interrompant l'alimentation électrique. Le four se remet automatiquement en fonctionnement lorsque la température baisse.

11. CONSEILS ET ASTUCES



Reportez-vous aux chapitres concernant la sécurité.

11.1 Conseils de cuisson

Le four dispose de quatre niveaux de grille.

Comptez les niveaux de grille à partir du bas du four.

Votre four peut cuire les aliments d'une manière complètement différente de celle de votre ancien four. Les tableaux ci-dessous vous indiquent les réglages standard pour la température, le temps de cuisson et le niveau du four.

Si vous ne trouvez pas les réglages appropriés pour une recette spécifique, cherchez-en une qui s'en rapproche.

Le four est doté d'un système spécial qui permet à l'air de circuler et qui recycle perpétuellement la vapeur. Dans cet environnement, ce système permet de cuisiner des plats tout en maintenant ceux-ci tendres à l'intérieur et croquants à l'extérieur. Le temps de cuisson et la consommation énergétique sont donc réduits.

Cuisson de gâteaux

N'ouvrez la porte du four qu'aux 3/4 du temps de cuisson défini.

Si vous utilisez deux plaques de cuisson en même temps, laissez un niveau libre entre les deux.

Cuisson de viande et de poisson

Avant de couper la viande, laissez-la reposer pendant environ 15 minutes afin d'éviter que le jus ne s'écoule.







Pour éviter qu'une trop grande quantité de fumée ne se forme dans le four, ajoutez de l'eau dans le plat à rôtir. Pour éviter que la fumée ne se condense, ajoutez à nouveau de l'eau dans le plat à rôtir à chaque fois qu'il n'en contient plus.

Temps de cuisson







Le temps de cuisson varie selon le type d'aliment, sa consistance et son volume.







Au départ, surveillez la cuisson lorsque vous cuisinez. Ainsi, vous trouverez les meilleurs réglages (fonction, temps de cuisson, etc.) pour vos ustensiles, vos recettes et les quantités lorsque vous utiliserez l'appareil.

11.2 Rôtissage et cuisson







 GÂ-TEAUX	Chauffage Haut/ Bas		Chaleur tournante		 (min)	
	 (°C)		 (°C)			
Recettes avec un fouet	170	2	160	2 (1 et 3)	45 - 60	Moule à gâteau
Pâte sablée	170	2	160	2 (1 et 3)	24 - 34	Moule à gâteau
Cheesecake au ba-beurre	170	1	160	2	60 - 80	Moule à gâteau, Ø 26 cm
Strudel	175	2	150	2	60 - 80	Plateau de cuisson
Tarte à la confiture	170	2	160	2	30 - 40	Moule à gâteau, Ø 26 cm
Gâteau aux fruits	170	2	155	2	60 - 70	Moule à gâteau, Ø 26 cm
Gâteau de Noël / Gâteau avec beaucoup de fruits	170	2	160	2	50 - 60	Moule à gâteau, Ø 20 cm
Gâteau aux prunes, préchauffer le four à vide	170	2	160	2	50 - 60	Moule à pain
Biscuits, préchauffer le four à vide	150	3	150	3	20 - 30	Plateau de cuisson
Meringues	100	3	100	3	90 - 120	Plateau de cuisson
Petits pains, préchauffer le four à vide	190	3	180	3	15 - 20	Plateau de cuisson
Pâte à choux, préchauffer le four à vide	190	3	180	3	25 - 35	Plateau de cuisson
Tartes sur plateau	180	3	170	2	45 - 70	Moule à gâteau, Ø 20 cm
Génoise Victoria	180	1 ou 2	170	2	40 - 55	Moule à gâteau, Ø 20 cm

Préchauffez le four à vide.

 PAIN ET PIZZA	Chauffage Haut/ Bas		Chaleur tournante		 (min)	
	 (°C)		 (°C)			
Pain blanc, 1 à 2 pièces, 0,5 kg chacune	190	1	190	1	60 - 70	-







 PAIN ET PIZZA	Chauffage Haut/ Bas		Chaleur tournante		 (min)	
	 (°C)		 (°C)			
Pain de seigle, le pré-chauffage n'est pas nécessaire	190	1	180	1	30 - 45	Moule à pain
Petits pains, 6 - 8 petits pains	190	2	180	2 (1 et 3)	25 - 40	Plateau de cuisson
Pizza	190	1	190	1	20 - 30	Plat à rôtir
Scones	200	3	190	2	10 - 20	Plateau de cuisson







Utilisez le moule à gâteaux.







 PRÉPARATIONS À BASE D'ŒUFS	Chauffage Haut/ Bas		Chaleur tournante		 (min)
	 (°C)		 (°C)		
Flan de pâtes	180	2	180	2	40 - 50
Flan de légumes	200	2	175	2	45 - 60
Quiches	190	1	190	1	40 - 50
Lasagne	200	2	200	2	25 - 40
Cannellonis	200	2	190	2	25 - 40
Yorkshire pudding, 6 moules à puddings, préchauffer le four à vide	220	2	210	2	20 - 30

Utilisez le deuxième niveau de la grille.

Utilisez la grille métallique.

 VIANDE	Chauffage Haut/ Bas		Chaleur tournante		 (min)
	 (°C)		 (°C)		
Bœuf	200		190		50 - 70
Porc	180		180		90 - 120
Veau	190		175		90 - 120
Rôti de bœuf, saignant	210		200		44 - 50
Rôti de bœuf, cuit à point	210		200		51 - 55
Rôti de bœuf, bien cuit	210		200		55 - 60

 VIANDE	Chauffage Haut/ Bas		Chaleur tournante		 (min)
	 (°C)		 (°C)		
Palette de porc, avec couenne	180	2	170	2	120 - 150
Jarret de porc, 2 morceaux	180	2	160	2	100 - 120
Gigot d'agneau	190	2	190	2	110 - 130
Poulet entier	200	2	200	2	70 - 85
Dinde entière	180	1	160	1	210 - 240
Canard entier	175	2	160	2	120 - 150
Oie entière	175	1	160	1	150 - 200
Lapin, en morceaux	190	2	175	2	60 - 80
Lièvre, en morceaux	190	2	175	2	150 - 200
Faisan entier	190	2	175	2	90 - 120





 POISSON	Chauffage Haut/ Bas		Chaleur tournante		 (min)
	 (°C)		 (°C)		
Truite / Dorade, 3 - 4 poissons	190	2	175	2 (1 et 3)	40 - 55
Thon / Saumon, 4 - 6 filets	190	2	175	2 (1 et 3)	35 - 60





11.3 Gril

Préchauffez le four à vide.

Utilisez le troisième niveau de la grille.

Réglez la température sur 250 °C.

 GRIL	 (kg)	 (min)	 (min)
		1ère face	2e face
Filets de bœuf, tranches, 4 morceaux	0,8	12 - 15	12 - 14
Steak de bœuf, 4 morceaux	0,6	10 - 12	6 - 8
Saucisses, 8	-	12 - 15	10 - 12
Côtelettes de porc, 4 morceaux	0,6	12 - 16	12 - 14
Poulet, demi, 2	1	30 - 35	25 - 30
Brochettes, 4	-	10 - 15	10 - 12
Blanc de poulet, 4 morceaux	0,4	12 - 15	12 - 14



 GRIL	 (kg)	 (min) 1ère face	 (min) 2e face
Hamburgers, 6	0,6	20 - 30	-
Filet de poisson, 4 morceaux	0,4	12 - 14	10 - 12
Sandwiches toastés, 4 - 6	-	5 - 7	-
Toasts, 4 - 6	-	2 - 4	2 - 3

11.4 Turbo gril





Préchauffez le four à vide.





Réglez la température sur 200 °C.

Utilisez le troisième niveau de la grille.

	 (kg)	 (min)	1ère face	2e face
Rôti roulé, dinde	1	30 - 40	20 - 30	
Poulet, demi, 2	1	25 - 30	20 - 30	
Pilons de poulet, 6 morceaux	-	15 - 20	15 - 18	
Caille, 4 morceaux	0,5	25 - 30	20 - 25	
Gratin de légumes	-	20 - 25	-	
Coquilles Saint-Jacques	-	15 - 20	-	
Maquereau, 2 - 4	-	15 - 20	10 - 15	
Darnes de poisson, 4 - 6	0,8	12 - 15	8 - 10	

11.5 Décongélation

	 (kg)	 Durée de décon- gélation (min)	 Décongélation com- plémentaire (min)	
Poulet	1	100 - 140	20 - 30	Placez le poulet sur une sous-tasse retournée, posée sur une grande assiette. Retournez à la moitié du temps.
Viande	1	100 - 140	20 - 30	Retournez à la moitié du temps.
	0,5	90 - 120		

	 (kg)	 Durée de décon- gélation (min)	 Décongélation com- plémentaire (min)	
Crème	2 x 0,2	80 - 100	10 - 15	La crème fraîche peut aussi être battue même si elle n'est pas complètement décongelée.
Truite	0,15	25 - 35	10 - 15	-
Fraises	0,3	30 - 40	10 - 20	-
Beurre	0,25	30 - 40	10 - 15	-
Gâteau	1,4	60	60	-

11.6 Chaleur tournante humide - accessoires recommandés

Utilisez les moules et récipients foncés et non réfléchissants. Ils offrent une meilleure absorption de la chaleur que les plats réfléchissants de couleur claire.

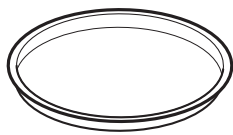

Plaque à pizza

Sombre, non réfléchissant
Diamètre de 28 cm



Plat de cuisson

Sombre, non réfléchissant
Diamètre de 26 cm



Ramequins

Céramique
8 cm de diamètre,
5 cm de hauteur

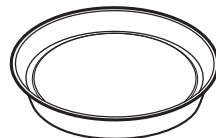











Moule pour fond de tarte

Sombre, non réfléchissant
Diamètre de 28 cm

11.7 Chaleur tournante humide







Pour de meilleurs résultats, suivez les suggestions indiquées dans le tableau ci-dessous.

		 (°C)		 (min)
Petits pains sucrés, (12 pièces)	Plateau de cuisson ou plat à rôtir	180	2	35 - 40
Petits pains, (9 pièces)	Plateau de cuisson ou plat à rôtir	180	2	35 - 40
Pizza, surgelée, 0,35 kg	grille métallique	220	2	35 - 40
Gâteau roulé	Plateau de cuisson ou plat à rôtir	170	2	30 - 40

		 (°C)		 (min)
Brownie	Plateau de cuisson ou plat à rôtir	180	2	30 - 40
Soufflé, (6 pièces)	ramequins en céramique sur une grille métallique	200	3	30 - 40
Fond de tarte en génoise	moule à tarte sur une grille métallique	170	2	20 - 30
Génoise Victoria	Plat de cuisson sur la grille métallique	170	2	35 - 45
Poisson poché, 0,3 kg	Plateau de cuisson ou plat à rôtir	180	3	35 - 45
Poisson entier, 0,2 kg	Plateau de cuisson ou plat à rôtir	180	3	35 - 45
Filet de poisson, 0,3 kg	plaque à pizza sur la grille métallique	180	3	35 - 45
Viande pochée, 0,25 kg	Plateau de cuisson ou plat à rôtir	200	3	40 - 50
Chachlyk, 0,5 kg	Plateau de cuisson ou plat à rôtir	200	3	25 - 35
Cookies, (16 pièces)	Plateau de cuisson ou plat à rôtir	180	2	20 - 30
Macarons, (20 pièces)	Plateau de cuisson ou plat à rôtir	180	2	40 - 45
Muffins, (12 pièces)	Plateau de cuisson ou plat à rôtir	170	2	30 - 40
Pâtisserie salée, (16 pièces)	Plateau de cuisson ou plat à rôtir	170	2	35 - 45
Biscuits à pâte brisée, (20 pièces)	Plateau de cuisson ou plat à rôtir	150	2	40 - 50
Tartelettes, (8 pièces)	Plateau de cuisson ou plat à rôtir	170	2	20 - 30
Légumes, pochés, 0,4 kg	Plateau de cuisson ou plat à rôtir	180	3	35 - 40
Omelette végétarienne	plaque à pizza sur la grille métallique	200	3	30 - 45
Légumes méditerranéens, 0,7 kg	Plateau de cuisson ou plat à rôtir	180	4	35 - 40

11.8 Informations pour les instituts de test

Tests conformément à la norme IEC 60350-1.

				 (°C)	 (min)	
Petits gâteaux, 20 par plateau	Chauffage Haut/ Bas	Plateau de cuisson	3	170	20 - 30	-
Tourte aux pommes, 2 moules Ø20 cm	Chauffage Haut/ Bas	Grille métallique	1	170	80 - 120	-
Génoise, moule à gâteau de 26 cm	Chauffage Haut/ Bas	Grille métallique	2	170	35 - 45	-
Sablé	Chauffage Haut/ Bas	Plateau de cuisson	3	150	20 - 35	Préchauffez le four pendant 10 minutes.
Toasts, 4 - 6 morceaux	Gril	Grille métallique	3	max.	2 à 4 minutes sur la première face ; 2 à 3 minutes sur la seconde face.	Préchauffez le four pendant 3 minutes.
Steak haché, 6 pièces, 0,6 kg	Gril	Grille métallique et lèche-frite	3	max.	20 - 30	Placez la grille métallique sur le troisième niveau et la lèche-frite sur le deuxième niveau du four. Tournez les aliments à mi-cuisson. Préchauffez le four pendant 3 minutes.

12. ENTRETIEN ET NETTOYAGE



AVERTISSEMENT!

Reportez-vous aux chapitres concernant la sécurité.

12.1 Remarques concernant l'entretien



Agents nettoyants

Nettoyez la façade du four avec un chiffon doux, de l'eau tiède et un détergent doux. Nettoyez et contrôlez le joint de la porte autour du cadre de la cavité.

Utilisez une solution de nettoyage pour nettoyer les surfaces métalliques.

Nettoyez les taches avec un détergent doux.



Utilisation quotidienne

Nettoyez la cavité après chaque utilisation. L'accumulation de graisse ou d'autres résidus peut provoquer un incendie.

De l'humidité peut se déposer dans l'enceinte du four ou sur les vitres de la porte. Pour diminuer la condensation, laissez fonctionner le four pendant 10 minutes avant la cuisson. Ne conservez pas les aliments dans le four pendant plus de 20 minutes. Sécher la cavité avec un chiffon doux après chaque utilisation.



Accessoires

Après chaque utilisation, lavez tous les accessoires et séchez-les. Utilisez un chiffon doux avec de l'eau tiède et un détergent doux. Ne lavez pas les accessoires au lave-vaisselle.

Ne nettoyez pas les accessoires antiadhésifs avec un produit nettoyant abrasif ou des objets tranchants.

12.2 Comment enlever : Supports de grille

Retirez les supports de grille pour nettoyer le four.

Étape 1 Éteignez le four et attendez qu'il soit froid.

Étape 2 Écartez l'avant du support de grille de la paroi latérale.

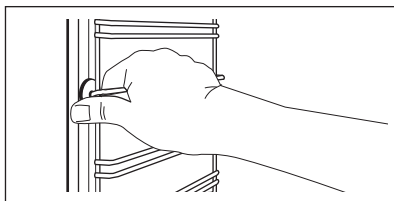

Étape 3 Écartez l'arrière du support de grille de la paroi latérale et retirez le support.

Étape 4 Réinstallez les supports de grille en répétant cette procédure dans l'ordre inverse.

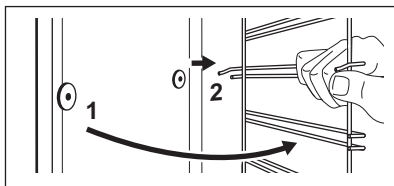

12.3 Comment démonter et installer : Porte

La porte du four est dotée de deux panneaux de verre. Vous pouvez retirer la porte du four ainsi que le panneau de verre intérieur afin de le nettoyer. Lisez toutes les instructions du chapitre « Retrait et installation de la porte » avant de retirer les panneaux de verre.



ATTENTION!

N'utilisez pas le four sans les panneaux en verre.

Étape 1 Ouvrez complètement la porte et saisissez les 2 charnières de porte.

Étape 2

Soulevez et faites tourner les leviers sur les 2 charnières.

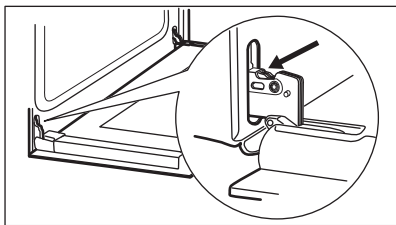

Étape 3 Fermez la porte du four à la première position d'ouverture (mi-parcours). Puis soulevez et tirez la porte vers l'avant et retirez-la de son logement.

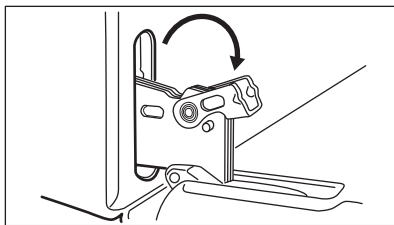

Étape 4 Mettez la porte sur un chiffon doux sur une surface stable et relâchez le système de verrouillage pour retirer le panneau de verre interne.

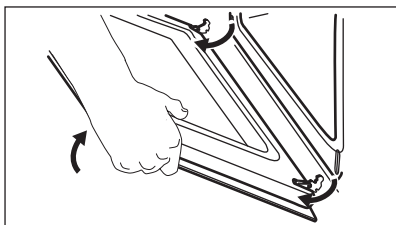

Étape 5 Faites pivoter les fixations de 90° et retirez-les de leurs logements.

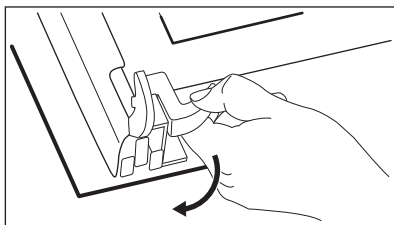

Étape 6 Soulevez doucement puis sortez le panneau de verre.

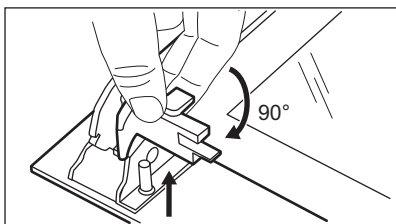

Étape 7 Nettoyez les panneaux de verre avec de l'eau savonneuse. Séchez soigneusement les panneaux de verre. Ne nettoyez pas les panneaux de verre au lave-vaisselle.

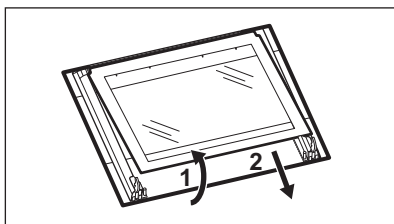

Étape 8 Après le nettoyage, installez le panneau de verre et la porte du four.

Lorsque le cadre de la porte est installé correctement, il émet un clic.
Veillez à installer correctement le panneau de verre intérieur dans son logement.

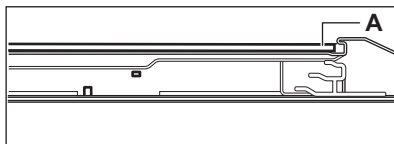

12.4 Comment remplacer : Éclairage



AVERTISSEMENT!
Risque d'électrocution.
L'éclairage peut être chaud.

Avant de remplacer l'éclairage :

Étape 1	Étape 2	Étape 3
Éteignez le four. Attendez que le four ait refroidi.	Débranchez le four de l'alimentation secteur.	Placez un chiffon au fond de la cavité.

Lampe arrière

- | | |
|----------------|--|
| Étape 1 | Tournez le diffuseur en verre pour le retirer. |
| Étape 2 | Nettoyez le diffuseur en verre. |
| Étape 3 | Remplacez l'éclairage par une ampoule adaptée résistant à une température de 300 °C. |
| Étape 4 | Remettez en place le diffuseur en verre. |

13. DÉPANNAGE



AVERTISSEMENT!

Reportez-vous aux chapitres concernant la sécurité.

13.1 Que faire si...

Dans tous les cas ne figurant pas dans ce tableau, veuillez contacter un service après-vente agréé.

Problème	Vérifiez si...
Le four ne chauffe pas.	Le fusible a disjoncté.
Le joint de la porte est endommagé.	N'utilisez pas le four. Contactez un service après-vente agréé.
L'affichage indique « 12.00 ».	Une coupure de courant s'est produite. Pour régler l'heure.

Problème

Vérifiez si...

L'éclairage ne fonctionne pas.	L'ampoule est grillée.
--------------------------------	------------------------

13.2 Données de maintenance

Si vous ne trouvez pas de solution au problème, veuillez contacter votre revendeur ou un service après-vente agréé.

Les informations à fournir au service après-vente figurent sur la plaque signalétique. La plaque signalétique se trouve sur l'encadrement avant de la cavité du four. Ne retirez pas la plaque signalétique de la cavité du four.

Nous vous recommandons de noter ces informations ici :

Modèle (MOD.)

Référence du produit (PNC)

Numéro de série (S.N.)

14. RENDEMENT ÉNERGÉTIQUE

14.1 Informations produit et Fiche d'informations produit*

Nom du fournisseur	Zanussi	
Identification du modèle	ZOHEE2X1 944068087 ZOHIE2X1 944068089	
Index d'efficacité énergétique	94.9	
Classe d'efficacité énergétique	A	
Consommation d'énergie avec charge standard et mode traditionnel	0.83 kWh/cycle	
Consommation d'énergie avec charge standard et mode air pulsé	0.75 kWh/cycle	
Nombre de cavités	1	
Source de chaleur	Électricité	
Volume	57 l	
Type de four	Four encastrable	
Masse	ZOHEE2X1	28.6 kg
	ZOHIE2X1	28.6 kg

* Pour l'Union européenne conformément aux Règlements UE 65/2014 et 66/2014.

Pour la République de Biélorussie conformément à STB 2478-2017, Annexe G ; STB 2477-2017, Annexes A et B.

Pour l'Ukraine conformément à 568/32020.

La classe d'efficacité énergétique n'est pas applicable pour la Russie.

EN 60350-1 - Appareils de cuisson domestiques électriques - Partie 1 : Plages, fours, fours à vapeur et grils - Méthodes de mesure des performances.

14.2 Économie d'énergie



Ce four est doté de caractéristiques qui vous permettent d'économiser de l'énergie lors de votre cuisine au quotidien.

Veillez à ce que la porte du four soit fermée lorsqu'il fonctionne. N'ouvrez pas la porte du four trop souvent pendant la cuisson. Gardez le joint de porte propre et veillez à ce qu'il soit bien fixé en place.

Utilisez des plats en métal pour accroître les économies d'énergie.

Si possible, ne préchauffez pas le four avant la cuisson.

Lorsque vous cuisez plusieurs plats les uns après les autres, veillez à ne pas trop espacer les cuissons.

Cuisson avec ventilation

Si possible, utilisez les fonctions de cuisson avec la ventilation pour économiser de l'énergie.

Chaleur résiduelle

Si la cuisson doit durer plus de 30 minutes, réduisez la température du four au minimum 3 à 10 minutes avant la fin de la cuisson. La chaleur résiduelle à l'intérieur du four poursuivra la cuisson.

Utilisez la chaleur résiduelle pour réchauffer d'autres plats.

Maintien des aliments au chaud

Sélectionnez la température la plus basse possible pour utiliser la chaleur résiduelle et maintenir le repas au chaud.

Chaleur tournante humide

Fonction conçue pour économiser de l'énergie en cours de cuisson.

15. EN MATIÈRE DE PROTECTION DE L'ENVIRONNEMENT

Recyclez les matériaux portant le symbole

 Déposez les emballages dans les conteneurs prévus à cet effet. Contribuez à la protection de l'environnement et à votre sécurité, recyclez vos produits électriques et électroniques. Ne jetez pas les appareils

portant le symbole  avec les ordures ménagères. Emmenez un tel produit dans votre centre local de recyclage ou contactez vos services municipaux.

BESUCHEN SIE UNSERE WEBSITE, UM:



Anwendungshinweise, Prospekte, Informationen zu Fehlerbehebung, Service und Reparatur zu erhalten:
www.zanussi.com/support

Änderungen vorbehalten.

INHALTSVERZEICHNIS

1. SICHERHEITSHINWEISE.....	72
2. SICHERHEITSANWEISUNGEN.....	74
3. MONTAGE.....	77
4. GERÄTEBESCHREIBUNG.....	78
5. BEDIENFELD.....	78
6. VOR DER ERSTEN INBETRIEBNAHME.....	79
7. TÄGLICHER GEBRAUCH.....	79
8. UHRFUNKTIONEN.....	80
9. VERWENDUNG DES ZUBEHÖRS.....	82
10. ZUSATZFUNKTIONEN.....	83
11. TIPPS UND HINWEISE.....	83
12. REINIGUNG UND PFLEGE.....	90
13. FEHLERSUCHE.....	93
14. ENERGIEEFFIZIENZ.....	93

1. ⚠ SICHERHEITSHINWEISE

Lesen Sie vor der Montage und dem Gebrauch des Geräts zuerst die Bedienungsanleitung. Bei Verletzungen oder Schäden infolge nicht ordnungsgemäßer Montage oder Verwendung übernimmt der Hersteller keine Haftung. Bewahren Sie die Anleitung zum Nachschlagen an einem sicheren und zugänglichen Ort auf.

1.1 Sicherheit von Kindern und schutzbedürftigen Personen

- Das Gerät kann von Kindern ab 8 Jahren und Personen mit eingeschränkten physischen, sensorischen oder geistigen Fähigkeiten oder mit mangelnder Erfahrung und/oder mangelndem Wissen nur dann verwendet werden, wenn sie durch eine für ihre Sicherheit zuständige Person beaufsichtigt werden oder in die sichere Verwendung des Geräts eingewiesen wurden und die mit dem Gerät

- verbundenen Gefahren verstanden haben. Kinder unter 8 Jahren und Personen mit schweren Behinderungen oder Mehrfachbehinderung müssen vom Gerät ferngehalten werden, wenn sie nicht ständig beaufsichtigt werden.
- Kinder dürfen nicht mit dem Gerät spielen.
 - Halten Sie sämtliches Verpackungsmaterial von Kindern fern und entsorgen Sie es ordnungsgemäß.
 - **WARNUNG:** Halten Sie Kinder und Haustiere während des Betriebs oder der Abkühlphase vom Gerät fern. Die zugänglichen Geräteteile werden beim Betrieb sehr heiß.
 - Falls Ihr Gerät mit einer Kindersicherung ausgestattet ist, empfehlen wir, diese einzuschalten.
 - Kinder dürfen keine Reinigung und Wartung ohne Beaufsichtigung durchführen.

1.2 Allgemeine Sicherheit

- Die Montage des Geräts und der Austausch des Kabels muss von einer Fachkraft vorgenommen werden.
- **WARNUNG:** Das Gerät und die zugänglichen Geräteteile werden während des Betriebs heiß. Seien Sie vorsichtig und berühren Sie niemals die Heizelemente.
- Verwenden Sie zum Anfassen des Zubehörs und der Töpfe wärmeisolierende Handschuhe.
- Ziehen Sie bitte vor jeder Wartungsmaßnahme den Netzstecker aus der Steckdose.
- **WARNUNG:** Vergewissern Sie sich, dass das Gerät ausgeschaltet ist, bevor Sie die Lampe austauschen, um einen Stromschlag zu vermeiden.
- Verwenden Sie das Gerät nicht, bevor es in den Einbauschrank gesetzt wird.
- Reinigen Sie das Gerät nicht mit einem Dampfstrahlreiniger.
- Benutzen Sie keine scharfe Scheuermittel oder Metallschwämmchen zum Reinigen der Glastür; sie können die Glasfläche verkratzen und zum Zersplittern der Scheibe führen.
- Wenn das Netzkabel beschädigt ist, muss es vom Hersteller, seinem autorisierten Kundenservice oder einer

gleichermaßen qualifizierten Person ausgetauscht werden, um Gefahren durch elektrischen Strom zu vermeiden.

- Ziehen Sie die Einhängegitter erst vorne und dann hinten von der Seitenwand weg und nehmen Sie sie heraus. Führen Sie zum Einsetzen der Einhängegitter die oben aufgeführten Schritte in umgekehrter Reihenfolge durch.

2. SICHERHEITSANWEISUNGEN

2.1 Montage



WARNUNG!

Die Montage des Geräts darf nur von einer qualifizierten Fachkraft durchgeführt werden.

- Entfernen Sie das gesamte Verpackungsmaterial.
- Montieren Sie ein beschädigtes Gerät nicht und benutzen Sie es nicht.
- Halten Sie sich an die mitgelieferte Montageanleitung.
- Seien Sie beim Umsetzen des Gerätes vorsichtig, da es sehr schwer ist. Tragen Sie stets Sicherheitshandschuhe und festes Schuhwerk.
- Ziehen Sie das Gerät nicht am Griff.
- Montieren Sie das Gerät an einem sicheren und geeigneten Ort, der den Montageanforderungen entspricht.
- Die Mindestabstände zu anderen Geräten und Küchenmöbeln sind einzuhalten.
- Überprüfen Sie vor der Montage des Gerätes, ob sich die Ofentür ohne Kraftanwendung öffnen lässt.
- Das Gerät ist mit einem elektrischen Kühlsystem ausgestattet. Es muss an die Stromversorgung angeschlossen werden.

Mindesthöhe des Einbaumöbels (Mindesthöhe des Schrankes unter der Arbeitsplatte)	590 (600) mm
--	--------------

Schrankbreite	560 mm
---------------	--------

Schranktiefe	550 (550) mm
--------------	--------------

Höhe der Gerätevorderseite	598 mm
----------------------------	--------

Höhe der Geräterückseite	579 mm
--------------------------	--------

Breite der Gerätevorderseite	594 mm
------------------------------	--------

Breite der Geräterückseite	558 mm
Gerätetiefe	561 mm
Geräteeinbautiefe	540 mm
Tiefe bei geöffneter Tür	1007 mm
Mindestgröße der Belüftungsöffnung. Öffnung auf der Rückseite unten	560x20 mm
Länge des Netzanschlusskabels. Das Kabel befindet sich in der rechten Ecke auf der Rückseite.	1100 mm
Befestigungsschrauben	4x25 mm

2.2 Elektroanschluss



WARNUNG!

Brand- und Stromschlaggefahr.

- Alle elektrischen Anschlüsse sind von einem geprüften Elektriker vorzunehmen.
- Das Gerät muss geerdet sein.
- Stellen Sie sicher, dass die Daten auf dem Typenschild mit den elektrischen Nennwerten der Netzspannung übereinstimmen.
- Schließen Sie das Gerät nur an eine ordnungsgemäß installierte Schutzkontaktsteckdose an.
- Verwenden Sie keine Mehrfachsteckdosen oder Verlängerungskabel.
- Achten Sie darauf, Netzstecker und Netzkabel nicht zu beschädigen. Falls das Netzkabel des Geräts ersetzt werden muss, lassen Sie diese Arbeit durch unseren autorisierten Kundendienst durchführen.
- Achten Sie darauf, dass das Netzkabel die Gerätetür oder die Nische unter dem

Gerät nicht berührt oder in ihre Nähe gelangt, insbesondere wenn das Gerät eingeschaltet oder die Tür heiß ist.

- Alle Teile, die gegen direktes Berühren schützen, sowie die isolierten Teile müssen so befestigt werden, dass sie nicht ohne Werkzeug entfernt werden können.
- Stecken Sie den Netzstecker erst nach Abschluss der Montage in die Steckdose. Stellen Sie sicher, dass der Netzstecker nach der Montage noch zugänglich ist.
- Falls die Steckdose lose ist, schließen Sie den Netzstecker nicht an.
- Ziehen Sie nicht am Netzkabel, wenn Sie das Gerät von der Stromversorgung trennen möchten. Ziehen Sie stets am Netzstecker.
- Verwenden Sie nur geeignete Trenneinrichtungen: Überlastschalter, Sicherungen (Schraub Sicherungen müssen aus dem Halter entfernt werden können), Fehlerstromschutzschalter und Schütze.
- Die elektrische Installation muss eine Trenneinrichtung aufweisen, mit der Sie das Gerät allpolig von der Stromversorgung trennen können. Die Trenneinrichtung muss mit einer Kontaktöffnungsbreite von mindestens 3 mm ausgeführt sein.
- Das Gerät wird mit einem Netzstecker und Netzkabel geliefert.

Einsetzbare Kabeltypen für Einbau oder Austausch in Europa:

H07 RN-F, H05 RN-F, H05 RRF, H05 VV-F, H05 V2V2-F (T90), H05 BB-F

Näheres zum Kabelquerschnitt siehe Gesamtleistung auf dem Typenschild. Weitere Informationen finden Sie in der Tabelle:

Gesamtleistung (W)	Kabelquerschnitt (mm ²)
Maximal 1380	3 x 0.75
Maximal 2300	3 x 1
Maximal 3680	3 x 1.5

Die Erdleitung (gelb/grünes Kabel) muss 2 cm länger sein als die Phasenleitung und der Nullleiter (blaues und braunes Kabel).



2.3 Bedienung



WARNUNG!

Verletzungs-, Verbrennungs-, Stromschlag- oder Explosionsgefahr.

- Dieses Gerät ist ausschließlich zur Verwendung im Haushalt bestimmt.
- Nehmen Sie keine technischen Änderungen am Gerät vor.
- Die Lüftungsöffnungen dürfen nicht abgedeckt werden.
- Lassen Sie das Gerät bei Betrieb nicht unbeaufsichtigt.
- Schalten Sie das Gerät nach jedem Gebrauch aus.
- Gehen Sie beim Öffnen der Tür vorsichtig vor, wenn das Gerät in Betrieb ist. Es kann heiße Luft austreten.
- Bedienen Sie das Gerät nicht mit feuchten oder nassen Händen oder wenn es mit Wasser in Kontakt gekommen ist.
- Üben Sie keinen Druck auf die geöffnete Gerätetür aus.
- Benutzen Sie das Gerät nicht als Arbeits- oder Abstellfläche.
- Öffnen Sie die Gerätetür vorsichtig. Bei der Verwendung von Zutaten, die Alkohol enthalten, kann ein Alkohol-Luftgemisch entstehen.
- Achten Sie beim Öffnen der Tür darauf, dass keine Funken oder offenen Flammen in das Gerät gelangen.
- Laden Sie keine entflammaren Produkte oder Gegenstände, die mit entflammaren Produkten benetzt sind, in das Gerät und stellen Sie solche nicht in die Nähe oder auf das Gerät.



WARNUNG!

Risiko von Schäden am Gerät.

- Um Beschädigungen und Verfärbungen der Emailbeschichtung zu vermeiden:
 - Stellen Sie feuerfestes Geschirr oder andere Gegenstände nicht direkt auf den Boden des Geräts.
 - Legen Sie keine Alufolie direkt auf den Boden des Garraums.

- Füllen Sie kein Wasser in das heiße Gerät.
- Lassen Sie nach Abschluss des Garvorgangs kein feuchtes Geschirr oder feuchte Speisen im Gerät stehen.
- Gehen Sie beim Herausnehmen oder Einsetzen des Zubehörs sorgfältig vor.
- Verfärbungen der Email- oder Edelstahlbeschichtung haben keine Auswirkung auf die Leistung des Geräts.
- Verwenden Sie für feuchte Kuchen das tiefe Blech. Fruchtsäfte können bleibende Flecken verursachen.
- Dieses Gerät ist nur zum Kochen bestimmt. Jeder andere Gebrauch ist als bestimmungsfremd anzusehen, zum Beispiel das Beheizen eines Raums.
- Die Backofentür muss beim Betrieb geschlossen sein.
- Ist das Gerät hinter einer Möbelfront (z. B. einer Tür) installiert, achten Sie darauf, dass die Tür während des Gerätebetriebs nicht geschlossen wird. Hinter einer geschlossenen Möbelfront können sich Hitze und Feuchtigkeit ansammeln und das Gerät, Gehäuse oder den Boden beschädigen. Schließen Sie die Möbelfront nicht, bevor das Gerät nach dem Gebrauch vollständig abgekühlt ist.

2.4 Reinigung und Pflege



WARNUNG!

Verletzungs-, Brandgefahr sowie Risiko von Schäden am Gerät.

- Schalten Sie das Gerät immer aus und ziehen Sie den Netzstecker aus der Steckdose, bevor Reinigungsarbeiten durchgeführt werden.
- Vergewissern Sie sich, dass das Gerät abgekühlt ist. Es besteht die Gefahr, dass die Glasscheiben brechen.
- Ersetzen Sie die Türglasscheiben umgehend, wenn sie beschädigt sind. Wenden Sie sich an einen autorisierten Kundendienst.
- Gehen Sie beim Aushängen der Tür vorsichtig vor. Die Tür ist schwer!
- Reinigen Sie das Gerät regelmäßig, um eine Verschlechterung des Oberflächenmaterials zu verhindern.

- Reinigen Sie das Gerats mit einem weichen, feuchten Tuch. Verwenden Sie ausschließlich Neutralreiniger. Benutzen Sie keine Scheuermittel, scheuernde Reinigungsschwammchen, Losungsmittel oder Metallgegenstande.
- Falls Sie ein Backofenspray verwenden, befolgen Sie die Sicherheitsanweisungen auf seiner Verpackung.

2.5 Innenbeleuchtung



WARNUNG!

Stromschlaggefahr.

- Bezüglich der Lampe(n) in diesem Gerät und separat verkaufter Ersatzlampen: Diese Lampen müssen extremen physikalischen Bedingungen in Haushaltsgeräten standhalten, wie z.B. Temperatur, Vibration, Feuchtigkeit, oder sollen Informationen über den Betriebszustand des Gerätes anzeigen. Sie sind nicht für den Einsatz in anderen Geräten vorgesehen und nicht für die Raumbeleuchtung geeignet.
- Verwenden Sie nur Lampen mit der gleichen Leistung .

2.6 Service

- Wenden Sie sich zur Reparatur des Geräts an den autorisierten Kundendienst.
- Verwenden Sie ausschließlich Originalersatzteile.

2.7 Entsorgung



WARNUNG!

Verletzungs- und Erstickungsgefahr.

- Trennen Sie das Gerät von der Stromversorgung.
- Schneiden Sie das Netzkabel in der Nähe des Geräts ab, und entsorgen Sie es.
- Entfernen Sie das Türschloss, um zu verhindern, dass sich Kinder oder Haustiere im Gerät einschließen.

4. GERÄTEBESCHREIBUNG

4.1 Gesamtansicht

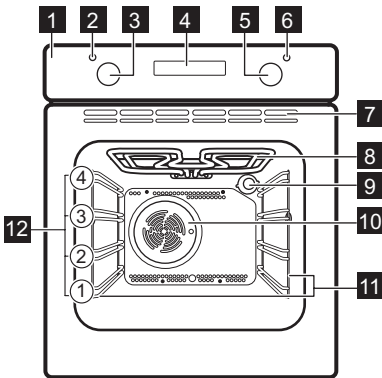

- 1 Bedienfeld
- 2 Betriebskontrolllampe/-symbol
- 3 Einstellknopf für die Ofenfunktionen
- 4 Display
- 5 Einstellknopf (für die Temperatur)
- 6 Temperaturanzeige/-symbol
- 7 Lüftungsöffnungen für das Kühlgebläse
- 8 Heizelement
- 9 Lampe
- 10 Ventilator
- 11 Einhängegitter, herausnehmbar
- 12 Einschubebenen

4.2 Zubehör

- **Kombirost**
Für Kochgeschirr, Kuchenformen, Braten.

- **Backblech**
Für Kuchen und Plätzchen.

5. BEDIENFELD

5.1 Sensorfelder/Tasten

—	Einstellen der Zeit.
⌚	Einstellen einer Uhrfunktion.
+	Einstellen der Zeit.

5.2 Display

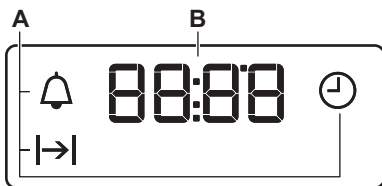

- A. Uhrfunktionen
- B. Timer

6. VOR DER ERSTEN INBETRIEBNAHME



WARNUNG!

Siehe Kapitel
Sicherheitshinweise.

6.1 Vor der ersten Inbetriebnahme

Der Backofen kann während des Aufheizens Geruch und Rauch verströmen. Stellen Sie sicher, dass der Raum belüftet ist.



Schritt 1



Schritt 2



Schritt 3

Stellen Sie die Uhrzeit ein

1. - zum Einstellen der Zeit drücken. Nach etwa 5 Sek. hört die Anzeige auf zu blinken und das Display zeigt die Zeit an.

Reinigen Sie den Backofen

1. Entfernen Sie alle Zubehörteile und die herausnehmbaren Einhängegitter aus dem Backofen.
2. Feuchten Sie ein weiches Tuch mit warmem Wasser und etwas mildem Reinigungsmittel an, und reinigen Sie damit den Backofen und das Zubehör.

Heizen Sie den leeren Backofen vor

1. Stellen Sie die Höchsttemperatur für folgende Funktion ein: Zeit: 1 Std.
2. Stellen Sie die Höchsttemperatur für folgende Funktion ein: Zeit: 15 min.
3. Stellen Sie die Höchsttemperatur für folgende Funktion ein: Zeit: 15 min.

Schalten Sie den Backofen aus und warten Sie, bis er abgekühlt ist. Setzen Sie die Zubehörteile und die herausnehmbaren Einhängegitter in den Backofen.

7. TÄGLICHER GEBRAUCH



WARNUNG!

Siehe Kapitel
Sicherheitshinweise.

7.1 Einstellung: Ofenfunktion

Schritt 1 Drehen Sie den Backofen-Einstellknopf auf eine Ofenfunktion.

Schritt 2 Drehen Sie den Wahlknopf, um die Temperatur auszuwählen.

Schritt 3 Drehen Sie nach Beendigung des Garvorgangs die Knöpfe in die Aus-Position, um den Backofen auszuschalten.

7.2 Ofenfunktionen

Ofenfunktion

Anwendung

0





Stellung Aus



Der Backofen ist ausgeschaltet.



Backofenbeleuchtung

Einschalten der Lampe.

Ofenfunktion	Anwendung
 Heißluft	<p>Zum Backen auf bis zu zwei Einschubebenen gleichzeitig und zum Dörren von Lebensmitteln.</p> <p>Stellen Sie eine 20 - 40 °C niedrigere Backofentemperatur als bei Ober-/Unterhitze ein.</p>
 Feuchte Umluft	<p>Diese Funktion ist entwickelt worden, um während des Garvorgangs Energie zu sparen. Wenn Sie diese Funktion nutzen, kann die Temperatur im Garraum von der eingestellten Temperatur abweichen. Die Wärmeleistung kann geringer sein. Weitere Informationen zu folgenden Themen finden Sie im Kapitel „Täglicher Gebrauch“: Feuchte Umluft.</p>
 Unterhitze	<p>Zum Backen von Kuchen mit knusprigen Böden und zum Einkochen von Lebensmitteln.</p>
 Auftauen	<p>Zum Auftauen von Lebensmitteln (Gemüse und Obst). Die Auftauzeit hängt ab von der Menge und Größe der Tiefkühlgerichte.</p>
 Grill	<p>Zum Grillen dünner Lebensmittel und zum Toasten von Brot.</p>

Ofenfunktion	Anwendung
 Grillstufe 2	<p>Zum Grillen dünner Lebensmittel in größeren Mengen und zum Toasten von Brot.</p>
 Heißluftgrillen	<p>Zum Braten großer Fleischstücke oder von Geflügel mit Knochen auf einer Ebene. Zum Gratinieren und Überbacken.</p>
 Ober-/Unterhitze	<p>Zum Backen und Braten auf einer Ebene.</p>

7.3 Hinweise zu: Feuchte Umluft



Diese Funktion wurde zur Bestimmung der Energieeffizienzklasse und den Anforderungen an die umweltgerechte Gestaltung EU 65/2014 und EU 66/2014 verwendet. Tests gemäß EN 60350-1.

Die Backofentür sollte während des Garvorgangs geschlossen bleiben, damit die Funktion nicht unterbrochen wird. So wird gewährleistet, dass der Backofen mit der höchsten Energieeffizienz arbeitet.

Die Kochanleitungen finden Sie im Kapitel "Hinweise und Tipps", Feuchte Umluft. Allgemeine Empfehlungen zur Energieeinsparung finden Sie im Kapitel „Energieeffizienz“, Energie sparen.

8. UHRFUNKTIONEN

8.1 Uhrfunktionen

Uhrfunktion	Anwendung
 Uhrzeit	<p>Zum Einstellen, Ändern oder Abfragen der Uhrzeit.</p>
 Dauer	<p>Einstellen der Einschaltdauer für den Backofen.</p>
 Kurzzeit-Wecker	<p>Zum Einstellen eines Countdowns. Diese Funktion wirkt sich nicht auf den Betrieb des Backofens aus. Sie können diese Funktion jederzeit und auch bei ausgeschaltetem Backofen einstellen.</p>

8.2 Einstellung: Uhrfunktionen

Einstellung: Uhrzeit

 blinkt, wenn Sie den Backofen an die Stromversorgung anschließen, nach einem Stromausfall und wenn der Timer nicht eingestellt ist.

+, **-** – zum Einstellen der Zeit drücken.

Nach etwa 5 Sek. hört die Anzeige auf zu blinken, und das Display zeigt die Zeit an.

Änderung: Uhrzeit

Schritt 1  – wiederholt drücken, um die Tageszeit zu ändern.  – beginnt zu blinken.

Schritt 2 **+**, **-** – zum Einstellen der Zeit drücken.

Nach etwa 5 Sek. hört die Anzeige auf zu blinken, und das Display zeigt die Zeit an.

Einstellung: Dauer

Schritt 1 Stellen Sie eine Ofenfunktion und die Temperatur ein.

Schritt 2  – wiederholt drücken.  – beginnt zu blinken.

Schritt 3 **+**, **-** – zum Einstellen der Dauer drücken.

Im Display wird Folgendes angezeigt: .

 – blinkt, wenn die eingestellte Zeit abgelaufen ist. Der Signalton ertönt, und der Backofen wird ausgeschaltet.

Schritt 4 Drücken Sie eine beliebige Taste, um das Signal abzustellen.

Schritt 5 Drehen Sie den Knopf in die Aus-Position.

Einstellung: Kurzzeit-Wecker

Schritt 1  – wiederholt drücken.  – beginnt zu blinken.

Schritt 2 **+**, **-** – zum Einstellen der Zeit drücken.

Die Funktion startet automatisch nach 5 Sekunden.

Nach Ablauf der eingestellten Zeit ertönt der Signalton.

Schritt 3 Drücken Sie eine beliebige Taste, um das Signal abzustellen.

Schritt 4 Drehen Sie den Knopf in die Aus-Position.

Abbrechen: Uhrfunktionen

Schritt 1  – wiederholt drücken, bis das Symbol der Uhrfunktion zu blinken anfängt.

Schritt 2 Drücken und halten Sie: **-**.

Die Uhrfunktion wird nach einigen Sekunden ausgeschaltet.

9. VERWENDUNG DES ZUBEHÖRS



WARNUNG!

Siehe Kapitel
Sicherheitshinweise.

dienen auch als Kippsicherung. Durch den umlaufend erhöhten Rand des Rosts ist das Kochgeschirr gegen Abrutschen vom Rost gesichert.

9.1 Einsetzen des Zubehörs

Die kleine Einkerbung auf der Oberseite erhöht die Sicherheit. Diese Einkerbungen

Kombirost:

Schieben Sie den Kombirost zwischen die Führungsschienen der Einhängegitter mit den Füßen nach unten zeigend.

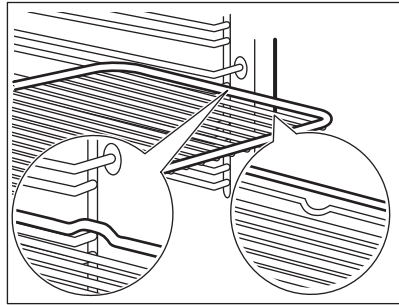

Backblech:

Schieben Sie das Blech zwischen die Führungsstäbe der Einhängegitter.

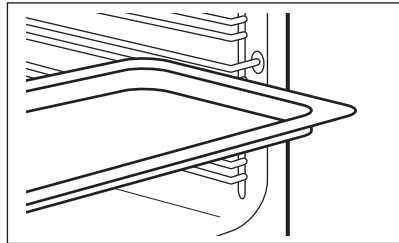

Kombirost, Backblech:

Schieben Sie das Backblech zwischen die Führungsstäbe der Einhängegitter und dem Kombirost auf die Führungsstäbe darüber.

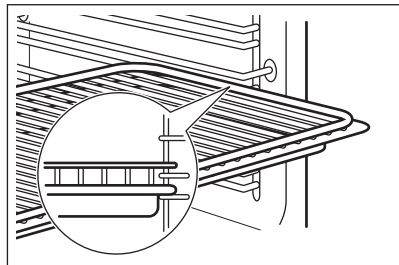

10. ZUSATZFUNKTIONEN

10.1 Kühlgebläse

Wenn der Backofen in Betrieb ist, wird das Kühlgebläse automatisch eingeschaltet, um die Ofenoberflächen zu kühlen. Wenn Sie den Backofen ausschalten kann das Kühlgebläse weiter laufen, bis der Ofen abgekühlt ist.

10.2 Sicherheitsthermostat

Ein unsachgemäßer Gebrauch des Ofens oder defekte Bestandteile können zu einer

gefährlichen Überhitzung führen. Um dies zu verhindern, ist der Backofen mit einem Sicherheitsthermostat ausgestattet, der die Stromzufuhr unterbrechen kann. Die Wiedereinschaltung des Backofens erfolgt automatisch bei Temperaturabfall.

11. TIPPS UND HINWEISE



Siehe Kapitel Sicherheitshinweise.

11.1 Garempfehlungen

Der Backofen hat vier Einschubebenen.

Die Ebenen werden vom Boden des Backofens aus gezählt.

Ihr Backofen backt oder brät unter Umständen anders als Ihr früherer Backofen. Die nachstehenden Tabellen enthalten die standardmäßigen Temperatureinstellungen, die Gardauer und die Einschubebene.

Finden Sie für ein bestimmtes Rezept keine konkreten Angaben, orientieren Sie sich an einem ähnlichem Rezept.

Der Backofen ist mit einem speziellen System ausgestattet, das die Luft zirkulieren lässt und den Dampf ständig wiederverwendet. Mit diesem System macht das Garen mit Dampf Ihre Speisen innen weich und außen knusprig. So verringert sich die Gardauer und der Energieverbrauch.

Backen von Kuchen

Die Backofentür nicht öffnen, bevor 3/4 der Backzeit abgelaufen ist.

Wenn Sie zwei Backbleche gleichzeitig nutzen, lassen Sie eine Ebene dazwischen frei.

Garen von Fleisch und Fisch

Lassen Sie das Fleisch vor dem Anschneiden etwa 15 Minuten ruhen, damit der Fleischsaft nicht ausläuft.







Um die Rauchbildung beim Braten im Backofen zu vermindern, geben Sie etwas Wasser in die Brat- und Fettpfanne. Um die Kondensierung des Rauchs zu vermeiden, geben Sie jedes Mal, wenn das Wasser verdampft ist, erneut Wasser in die Brat- und Fettpfanne.

Garzeiten







Die Garzeiten hängen von der Art des Garguts, seiner Konsistenz und der Menge ab.







Beobachten Sie den Garfortschritt. Finden Sie heraus, welche Geräteeinstellungen (Garstufe, Gardauer, usw.) für Ihr Kochgeschirr, Ihre Rezepte und die von Ihnen zubereiteten Garmengen am besten geeignet sind.

11.2 Backen und Braten







 KU- CHEN	Ober-/Unterhitze		Heißluft		 (Min.)	
	 (°C)		 (°C)			
Rührteig	170	2	160	2 (1 und 3)	45 – 60	Kuchenform
Mürbeteig	170	2	160	2 (1 und 3)	24 – 34	Kuchenform
Buttermilch-Käsekuchen	170	1	160	2	60 – 80	Kuchenform, Ø 26 cm
Strudel/Stollen	175	2	150	2	60 – 80	Backblech
Marmeladentorte	170	2	160	2	30 – 40	Kuchenform, Ø 26 cm
Frühtekuchen	170	2	155	2	60 – 70	Kuchenform, Ø 26 cm
Christstollen / Üppiger Obstkuchen	170	2	160	2	50 – 60	Kuchenform, Ø 20 cm
Rosinenkuchen, Heizen Sie den leeren Backofen vor	170	2	160	2	50 – 60	Brotforn
Kekse, Heizen Sie den leeren Backofen vor	150	3	150	3	20 – 30	Backblech
Baiser	100	3	100	3	90 – 120	Backblech
Brötchen, Heizen Sie den leeren Backofen vor	190	3	180	3	15 – 20	Backblech
Brandteiggebäck, Heizen Sie den leeren Backofen vor	190	3	180	3	25 – 35	Backblech
Törtchen	180	3	170	2	45 – 70	Kuchenform, Ø 20 cm
Englischer Sandwichkuchen à la Victoria	180	1 oder 2	170	2	40 – 55	Kuchenform, Ø 20 cm

Heizen Sie den leeren Backofen vor.

 BROT UND PIZZA	Ober-/Unterhitze		Heißluft		 (Min.)	
	 (°C)		 (°C)			
Weißbrot, 1 - 2 Stück, je 0,5 kg	190	1	190	1	60 – 70	–





 BROT UND PIZZA	Ober-/Unterhitze		Heißluft		 (Min.)	
	 (°C)		 (°C)			
Roggenbrot, Vorheizen ist nicht erforderlich	190	1	180	1	30 – 45	Brotform
Brot/Brötchen, 6 - 8 Brötchen	190	2	180	2 (1 und 3)	25 – 40	Backblech
Pizza	190	1	190	1	20 – 30	Tiefes Blech
Scones	200	3	190	2	10 – 20	Backblech







Verwenden Sie die Kuchenform.







 OBSTKUCHEN	Ober-/Unterhitze		Heißluft		 (Min.)
	 (°C)		 (°C)		
Nudelauflauf	180	2	180	2	40 – 50
Gemüseauflauf	200	2	175	2	45 – 60
Quiche	190	1	190	1	40 – 50
Lasagne	200	2	200	2	25 – 40
Cannelloni	200	2	190	2	25 – 40
Yorkshire-Pudding, 6 Puddingformen, Heizen Sie den leeren Backofen vor	220	2	210	2	20 – 30

Nutzen Sie die zweite Einschubebene.

Verwenden Sie den Kombirost.

 FLEISCH	Ober-/Unterhitze		Heißluft		 (Min.)
	 (°C)		 (°C)		
Rind	200		190		50 – 70
Schweinefleisch	180		180		90 – 120
Kalb	190		175		90 – 120
Roastbeef, englisch, blutig	210		200		44 – 50
Roastbeef, englisch, rosa	210		200		51 – 55
Roastbeef, englisch, durch	210		200		55 – 60

 FLEISCH	Ober-/Unterhitze		Heißluft		 (Min.)
	 (°C)		 (°C)		
Schweineschulter, mit Schwarte	180	2	170	2	120 – 150
Schweinschaxe, 2 Stück	180	2	160	2	100 – 120
Lammkeule	190	2	190	2	110 – 130
Hähnchen, ganz	200	2	200	2	70 – 85
Pute, ganz	180	1	160	1	210 – 240
Ente, ganz	175	2	160	2	120 – 150
Gans, ganz	175	1	160	1	150 – 200
Kaninchen, in Stücke geschnitten	190	2	175	2	60 – 80
Kaninchen, in Stücke geschnitten	190	2	175	2	150 – 200
Fasan, ganz	190	2	175	2	90 – 120





 FISCH	Ober-/Unterhitze		Heißluft		 (Min.)
	 (°C)		 (°C)		
Forelle / Seebrasse, 3 - 4 Fische	190	2	175	2 (1 und 3)	40 – 55
Thunfisch / Lachs, 4 - 6 Filets	190	2	175	2 (1 und 3)	35 – 60





11.3 Grill

Leeren Backofen vorheizen.

Nutzen Sie die dritte Einschubebene.

Stellen Sie die Temperatur auf 250 °C ein.

 GRILL	 (kg)	 (Min.)	 (Min.)
		Erste Seite	Zweite Seite
Filetsteaks, 4 Stück	0.8	12 - 15	12 - 14
Rindersteak, 4 Stück	0.6	10 - 12	6 - 8
Würstchen, 8	-	12 - 15	10 - 12
Schweinekoteletts, 4 Stück	0.6	12 - 16	12 - 14
Hähnchen, halbiert, 2	1	30 - 35	25 - 30





 GRILL	 (kg)	 (Min.) Erste Seite	 (Min.) Zweite Seite
Spieße, 4	-	10 - 15	10 - 12
Hähnchenbrust, 4 Stück	0.4	12 - 15	12 - 14
Frikadellen, 6	0.6	20 - 30	-
Fischfilet, 4 Stück	0.4	12 - 14	10 - 12
Belegte Toastbrote, 4 - 6	-	5 - 7	-
Toast, 4 - 6	-	2 - 4	2 - 3

11.4 Heißluftgrillen





Leeren Backofen vorheizen.





Stellen Sie die Temperatur auf 200 °C ein.

Nutzen Sie die dritte Einschubebene.

	 (kg)	 (Min.) Erste Seite	 (Min.) Zweite Seite
Rollbraten, Pute	1	30 - 40	20 - 30
Hähnchen, halbiert, 2	1	25 - 30	20 - 30
Hähnchenunterschenkel, 6 Stück	-	15 - 20	15 - 18
Wachtel, 4 Stück	0.5	25 - 30	20 - 25
Gemüsegratin	-	20 - 25	-
Jakobsmuscheln	-	15 - 20	-
Makrele, 2 - 4	-	15 - 20	10 - 15
Fischscheiben, 4 - 6	0.8	12 - 15	8 - 10

11.5 Auftauen

	 (kg)	 Auftauzeit (Min.)	 Zusätzliche Auftauzeit (Min.)	
Hähnchen	1	100 - 140	20 - 30	Legen Sie das Hähnchen auf eine umgedrehte Untertasse auf einem größeren Teller. Nach der Hälfte der Gardauer wenden.

	 (kg)	 Auftauzeit (Min.)	 Zusätzliche Auftauzeit (Min.)	
Fleisch	1 0,5	100 – 140 90 – 120	20 – 30	Nach der Hälfte der Gardauer wenden.
Sahne	2 x 0,2	80 – 100	10 – 15	Sahne lässt sich auch mit noch leicht gefrorenen Stellen gut aufschlagen.
Forelle	0,15	25 – 35	10 – 15	–
Erdbeeren	0,3	30 – 40	10 – 20	–
Butter	0,25	30 – 40	10 – 15	–
Torte	1,4	60	60	–

11.6 Feuchte Umluft - Empfohlenes Zubehör

Verwenden Sie die dunklen und nicht reflektierenden Formen und Behälter. Sie haben eine bessere Wärmeabsorption als helle Farbe und reflektierende Schüsseln.



Pizzapfanne

Dunkel, nicht reflektierend
28 cm Durchmesser



Backform

Dunkel, nicht reflektierend
26 cm Durchmesser



Förmchen

Keramikform
8 cm Durchmesser,
5 cm Höhe













Tortenbodenform

Dunkel, nicht reflektierend
28 cm Durchmesser

11.7 Feuchte Umluft







Beachten Sie für beste Ergebnisse die unten in der Tabelle aufgeführten Empfehlungen.







		 (°C)		 (Min.)
Brötchen, süß, 12 Stück	Backblech oder tiefes Blech	180	2	35 - 40
Brötchen, 9 Stück	Backblech oder tiefes Blech	180	2	35 - 40
Pizza, gefroren, 0,35 kg	Kombirost	220	2	35 - 40
Biskuitrolle	Backblech oder tiefes Blech	170	2	30 - 40
Brownie	Backblech oder tiefes Blech	180	2	30 - 40

		 (°C)		 (Min.)
Soufflé, 6 Stück	Keramikförmchen auf Kombi-rost	200	3	30 - 40
Biskuitboden	Biskuitform auf Kombirost	170	2	20 - 30
Englischer Sandwichkuchen à la Victoria	Backform auf Kombirost	170	2	35 - 45
Fisch, pochiert, 0,3 kg	Backblech oder tiefes Blech	180	3	35 - 45
Fisch, 0,2 kg	Backblech oder tiefes Blech	180	3	35 - 45
Fischfilet, 0,3 kg	Pizzapfanne auf Kombirost	180	3	35 - 45
Fleisch, pochiert, 0,25 kg	Backblech oder tiefes Blech	200	3	40 - 50
Schaschlik, 0,5 kg	Backblech oder tiefes Blech	200	3	25 - 35
Plätzchen, 16 Stück	Backblech oder tiefes Blech	180	2	20 - 30
Makronen, 20 Stück	Backblech oder tiefes Blech	180	2	40 - 45
Muffins, 12 Stück	Backblech oder tiefes Blech	170	2	30 - 40
Kleingebäck, pikant, 16 Stück	Backblech oder tiefes Blech	170	2	35 - 45
Mürbeteigplätzchen, 20 Stück	Backblech oder tiefes Blech	150	2	40 - 50
Törtchen, 8 Stück	Backblech oder tiefes Blech	170	2	20 - 30
Gemüse, pochiert, 0,4 kg	Backblech oder tiefes Blech	180	3	35 - 40
Vegetarisches Omelett	Pizzapfanne auf Kombirost	200	3	30 - 45
Mediterranes Gemüse, 0,7 kg	Backblech oder tiefes Blech	180	4	35 - 40

11.8 Informationen für Prüfinstitute

Tests gemäß IEC 60350-1.

				 (°C)	 (Min.)	
Törtchen, 20 pro Blech	Ober-/Unterhitze	Backblech	3	170	20 - 30	-
Apfelkuchen, 2 Formen à Ø 20 cm	Ober-/Unterhitze	Kombirost	1	170	80 - 120	-
Biskuit, Kuchenform Ø 26 cm	Ober-/Unterhitze	Kombirost	2	170	35 - 45	-

						
				(°C)	(Min.)	
Mürbeteiggebäck	Ober-/Unterhitze	Backblech	3	150	20 - 35	Backofen 10 Min. vorheizen.
Toast, 4 - 6 Stück	Grill	Kombirost	3	Max.	2 - 4 Minuten auf der ersten Seite, 2 - 3 Minuten auf der zweiten Seite	Backofen 3 Min. vorheizen.
Hamburger aus Rindfleisch, 6 Stück, 0,6 kg	Grill	Kombirost und Fettpfanne	3	Max.	20 - 30	Kombirost in die dritte und Fettpfanne in die zweite Einschubebene des Backofens einschieben. Wenden Sie das Lebensmittel nach der Hälfte der Gardauer. Backofen 3 Min. vorheizen.

12. REINIGUNG UND PFLEGE



WARNUNG!

Siehe Kapitel Sicherheitshinweise.

12.1 Hinweise zur Reinigung



Feuchten Sie ein weiches Tuch mit warmem Wasser und etwas mildem Reinigungsmittel an, und reinigen Sie damit die Vorderseite des Backofens. Reinigen und überprüfen Sie die Türdichtung um den Garraumrahmen.

Reinigen Sie die Metalloberflächen mit einer Reinigungslösung.

Reinigungsmittel

Reinigen Sie Flecken mit einem milden Reinigungsmittel.



Täglicher Gebrauch

Reinigen Sie den Garraum nach jedem Gebrauch. Fettansammlungen oder andere Speisereste könnten einen Brand verursachen.

Es kann sich Feuchtigkeit im Ofen oder an den Glasscheiben der Tür niederschlagen. Um die Kondensation zu reduzieren, schalten Sie den Backofen immer 10 Minuten vor dem Garen ein. Lassen Sie die Speisen nicht länger als 20 Minuten im Backofen stehen. Trocknen Sie den Garraum nach jedem Gebrauch mit einem weichen Tuch ab.



Zubehör

Reinigen Sie alle Zubehörteile nach jedem Gebrauch und lassen Sie sie trocknen. Feuchten Sie ein weiches Tuch mit warmem Wasser und einem milden Reinigungsmittel an. Reinigen Sie die Zubehörteile nicht im Geschirrspüler.

Reinigen Sie das Zubehör mit Antihafbeschichtung nicht mit Scheuermitteln oder scharfkantigen Gegenständen.

12.2 Entfernen: Einhängegitter

Entfernen Sie Einhängegitter zur Reinigung des Backofens.

Schritt 1 Schalten Sie den Backofen aus und warten Sie, bis er abgekühlt ist.

Schritt 2 Ziehen Sie das Einhängegitter vorne von der Seitenwand weg.

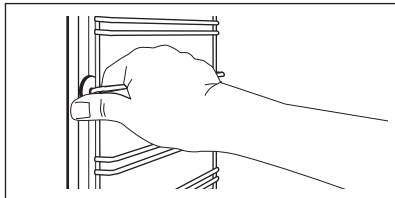

Schritt 3 Ziehen Sie das Einhängegitter hinten von der Seitenwand weg und nehmen Sie es heraus.

Schritt 4 Führen Sie zum Einsetzen der Einhängegitter die oben aufgeführten Schritte in umgekehrter Reihenfolge durch.

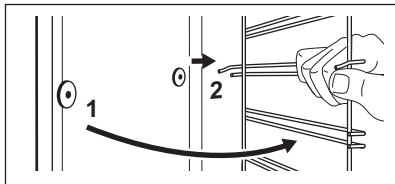

12.3 Aus- und Einbau der: Tür

Die Backofentür hat zwei Glasscheiben. Die Backofentür und die innere Glasscheibe können zur Reinigung ausgebaut werden. Lesen Sie die gesamte Anleitung „Aus- und Einbauen der Tür“, bevor Sie die Glasscheiben entfernen.



VORSICHT!

Benutzen Sie den Backofen nicht ohne die Glasscheiben.

Schritt 1 Öffnen Sie die Backofentür vollständig und halten Sie beide Scharniere fest.

Schritt 2 Heben Sie die Hebel an den beiden Scharnieren an und klappen Sie sie nach vorne.

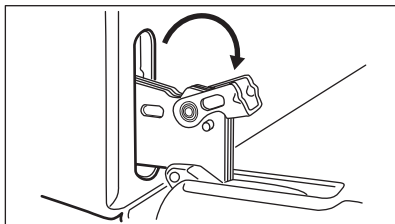
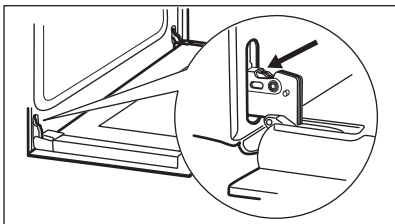

Schritt 3 Schließen Sie die Backofentür halb bis zur ersten Raststellung. Anschließend heben und ziehen Sie die Tür nach vorn aus der Aufnahme heraus.

Schritt 4 Legen Sie die Backofentür auf eine stabilen Fläche und lösen Sie das Verriegelungssystem, um die innere Glasscheibe zu entfernen.

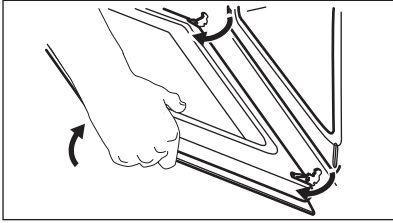

Schritt 5 Drehen Sie die Befestigungen um 90° und nehmen Sie sie aus der Halterung.

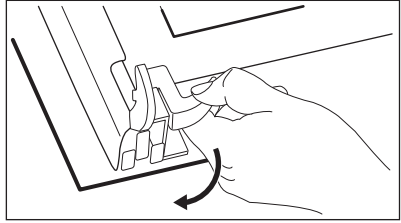

Schritt 6 Heben Sie die Glasscheibe vorsichtig an und entfernen Sie sie.

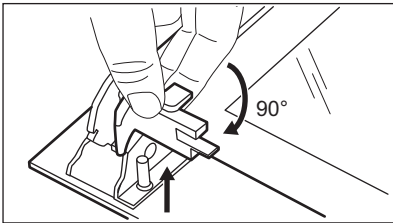

Schritt 7 Reinigen Sie die Glasscheiben mit Wasser und Spülmittel. Trocknen Sie die Glasscheiben sorgfältig ab. Reinigen Sie die Glasscheiben nicht im Geschirrspüler.

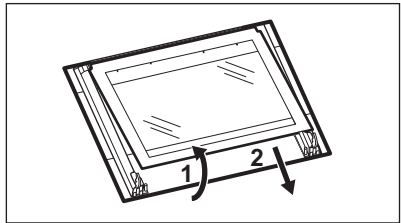

Schritt 8 Setzen Sie nach der Reinigung die Glasscheibe und die Backofentür ein

Bei korrektem Einbau macht die Türabdeckung ein Klickgeräusch. Achten Sie darauf, die innere Glasscheibe richtig in die Aufnahmen einzusetzen.

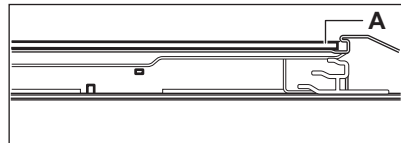

12.4 Austausch: Lampe



WARNUNG!
Stromschlaggefahr.
Die Lampe kann heiß sein.

Bevor Sie die Lampe austauschen:

Schritt 1	Schritt 2	Schritt 3
Schalten Sie den Backofen aus. Warten Sie, bis der Ofen kalt ist.	Trennen Sie den Ofen von der Netzversorgung.	Breiten Sie ein Tuch auf dem Garraumboden aus.

Hintere Lampe

Schritt 1 Drehen Sie die Glasabdeckung und nehmen Sie sie ab.

Schritt 2 Reinigen Sie die Glasabdeckung.

Schritt 3 Ersetzen Sie die Lampe durch eine geeignete, bis 300 °C hitzebeständige Lampe.

Schritt 4 Bringen Sie die Glasabdeckung wieder an.

13. FEHLERSUCHE



WARNUNG!

Siehe Kapitel
Sicherheitshinweise.

13.1 Was tun, wenn...

In allen Fällen, die nicht in dieser Tabelle aufgeführt sind, wenden Sie sich bitte an einen autorisierten Kundendienst.

Störung	Prüfen Sie, ob...
Der Backofen nicht heizt.	Die Sicherung durchgebrannt ist.
Die Türdichtung beschädigt ist.	Benutzen Sie den Ofen nicht. Wenden Sie sich an den autorisierten Kundendienst.

Störung	Prüfen Sie, ob...
Das Display „12.00“ anzeigt.	Es einen Stromausfall gab. Stellen Sie die Uhrzeit ein.
Die Lampe nicht funktioniert.	Die Lampe durchgebrannt ist.

13.2 Servicedaten

Wenn Sie das Problem nicht selbst lösen können, wenden Sie sich an Ihren Händler oder einen autorisierten Kundendienst.

Die vom Kundendienst benötigten Daten finden Sie auf dem Typenschild. Das Typenschild befindet sich am Frontrahmen des Garraums. Entfernen Sie das Typenschild nicht vom Garraum.

Wir empfehlen, hier folgende Daten zu notieren:

Modell (MOD.)

Produktnummer (PNC)

Seriennummer (S.N.)

14. ENERGIEEFFIZIENZ

14.1 Produktinformationen und Produktdatenblatt*

Herstellername	Zanussi
Modellidentifikation	ZOHEE2X1 944068087 ZOHIE2X1 944068089
Energieeffizienzindex	94.9
Energieeffizienzklasse	A

Energieverbrauch bei Standardbelastung, Ober-/Unterhitze	0.83 kWh/Programm	
Energieverbrauch bei Standardbelastung, Umluft	0.75 kWh/Programm	
Anzahl der Garräume	1	
Wärmequelle	Strom	
Fassungsvermögen	57 l	
Backofentyp	Einbau-Backofen	
Gewicht	ZOHEE2X1	28.6 kg
	ZOHIE2X1	28.6 kg

* Für die Europäische Union gemäß EU-Richtlinien 65/2014 und 66/2014.

Für die Republik Weißrussland gemäß STB 2478-2017, Anhang G; STB 2477-2017, Anlagen A und B.

Für die Ukraine gemäß 568/32020.

Die Energieeffizienzklasse gilt nicht für Russland.

EN 60350-1 - Elektrische Kochgeräte für den Hausgebrauch - Teil 1: Herde, Backöfen, Dampfgarer und Grillgeräte - Verfahren zur Messung der Gebrauchseigenschaften.

14.2 Energie sparen



Der Backofen verfügt über Funktionen, mit deren Hilfe Sie beim täglichen Kochen Energie sparen können.

Achten Sie darauf, dass die Backofentür während des Ofenbetriebs geschlossen ist. Die Backofentür darf während des Garvorgangs nicht zu oft geöffnet werden. Halten Sie die Türdichtung sauber und stellen Sie sicher, dass sie sich fest in der richtigen Position befindet.

Verwenden Sie Kochgeschirr aus Metall, um mehr Energie zu sparen.

Heizen Sie, wenn möglich, den Backofen nicht vor.

Halten Sie die Unterbrechungen beim Backen so kurz wie möglich, wenn Sie mehrere Speisen gleichzeitig zubereiten.

Garen mit Heißluft

Nutzen Sie, wenn möglich, die Garfunktionen mit Heißluft, um Energie zu sparen.

Restwärme

Beträgt die Garzeit mehr als 30 Minuten, reduzieren Sie die Ofentemperatur 3 - 10 Min. vor Ablauf des Garvorgangs. Durch die Restwärme des Backofens werden die Speisen weiter gegart.

Nutzen Sie die Restwärme, um andere Speisen aufzuwärmen.

Warmhalten von Speisen

Wählen Sie die niedrigste Temperatureinstellung, wenn Sie die Restwärme zum Warmhalten von Speisen nutzen möchten.

Feuchte Umluft

Diese Funktion ist entwickelt worden, um während des Garvorgangs Energie zu sparen.

15. UMWELTTIPPS

Recyceln Sie Materialien mit dem Symbol . Entsorgen Sie die Verpackung in den entsprechenden Recyclingbehältern.

Recyceln Sie zum Umwelt- und Gesundheitsschutz elektrische und elektronische Geräte. Entsorgen Sie Geräte

mit diesem Symbol  nicht mit dem Hausmüll. Bringen Sie das Gerät zu Ihrer

örtlichen Sammelstelle oder wenden Sie sich an Ihr Gemeindeamt.

VISITE O NOSSO WEBSITE PARA:



Resolver problemas e obter conselhos de utilização, catálogos e informações sobre assistência e reparações:
www.zanussi.com/support

Sujeito a alterações sem aviso prévio.

ÍNDICE

1. INFORMAÇÕES DE SEGURANÇA.....	96
2. INSTRUÇÕES DE SEGURANÇA.....	98
3. INSTALAÇÃO.....	101
4. DESCRIÇÃO DO PRODUTO.....	102
5. PAINEL DE COMANDOS.....	102
6. ANTES DA PRIMEIRA UTILIZAÇÃO.....	103
7. UTILIZAÇÃO DIÁRIA.....	103
8. FUNÇÕES DE RELÓGIO.....	104
9. UTILIZAR OS ACESSÓRIOS.....	106
10. FUNÇÕES ADICIONAIS.....	107
11. SUGESTÕES E DICAS.....	107
12. MANUTENÇÃO E LIMPEZA.....	114
13. RESOLUÇÃO DE PROBLEMAS.....	117
14. EFICIÊNCIA ENERGÉTICA.....	118

1. ⚠️ INFORMAÇÕES DE SEGURANÇA

Leia atentamente as instruções fornecidas antes de instalar e utilizar o aparelho. O fabricante não é responsável por quaisquer ferimentos ou danos resultantes de instalação ou utilização incorretas. Guarde sempre as instruções em local seguro e acessível para consultar no futuro.

1.1 Segurança de crianças e pessoas vulneráveis

- Este aparelho pode ser utilizado por crianças de 8 ou mais anos de idade e por pessoas com capacidades físicas, sensoriais ou mentais reduzidas ou com pouca experiência e conhecimento se tiverem recebido supervisão ou instruções relativas à utilização do aparelho de forma segura e compreenderem os perigos envolvidos. É necessário manter as crianças com menos de 8 anos de idade e pessoas com incapacidades muito extensas e

complexas afastadas do aparelho, a menos que constantemente vigiadas.

- Não permita que crianças brinquem com o aparelho.
- Mantenha todos os materiais de embalagem fora do alcance das crianças e elimine-os de forma apropriada.
- AVISO: Mantenha as crianças e os animais domésticos afastados do aparelho quando ele estiver a funcionar ou a arrefecer. As partes acessíveis ficam quentes durante a utilização.
- Se o aparelho tiver um dispositivo de segurança para crianças, recomendamos que o active.
- A limpeza e a manutenção básica do aparelho não devem ser efectuadas por crianças sem supervisão.

1.2 Segurança geral

- Apenas uma pessoa qualificada pode instalar este aparelho e substituir o cabo.
- AVISO: O aparelho e as partes acessíveis ficam quentes durante a utilização. Deve ter cuidado para evitar tocar nas resistências de aquecimento.
- Utilize sempre luvas de forno para retirar e colocar acessórios ou recipientes de ir ao forno.
- Antes de efetuar qualquer ação de manutenção, desligue o aparelho da corrente elétrica.
- AVISO: Certifique-se de que o aparelho está desligado antes de substituir a lâmpada, para evitar a possibilidade de choque elétrico.
- Não use o aparelho antes de instalá-lo na estrutura embutida.
- Não utilize uma máquina de limpar a vapor para limpar o aparelho.
- Não utilize agentes de limpeza abrasivos ou raspadores metálicos afiados para limpar a porta de vidro, porque podem riscar a superfície e causar a quebra do vidro.
- Se o cabo de alimentação elétrica estiver danificado, deve ser substituído pelo fabricante, por um Centro de Assistência Técnica Autorizado ou por uma pessoa igualmente qualificada, para evitar perigos elétricos.

- Para remover os apoios para prateleiras, puxe primeiro a parte da frente e depois a parte de trás do apoio para prateleiras para fora da parede lateral. Instale os apoios para prateleiras na sequência inversa.

2. INSTRUÇÕES DE SEGURANÇA

2.1 Instalação



AVISO!

A instalação deste aparelho tem de ser efetuada por uma pessoa qualificada.

- Retire a embalagem toda.
- Não instale nem utilize o aparelho se estiver danificado.
- Siga as instruções de instalação fornecidas com o aparelho.
- Tenha sempre cuidado quando deslocar o aparelho porque ele é pesado. Utilize sempre luvas de proteção e calçado fechado.
- Não puxe o aparelho pela pega.
- Instale o aparelho num local seguro e adequado que cumpra com os requisitos da instalação.
- Respeite as distâncias mínimas relativamente a outros aparelhos e unidades.
- Antes de montar o aparelho, verifique se a porta do forno abre sem limitações.
- O aparelho está equipado com um sistema de arrefecimento elétrico. É necessário que tenha alimentação elétrica.

Altura mínima do armário (altura mínima do armário debaixo do balcão)	590 (600) mm
---	--------------

Largura do armário	560 mm
--------------------	--------

Profundidade do armário	550 (550) mm
-------------------------	--------------

Altura da parte da frente do aparelho	598 mm
--	--------

Altura da parte de trás do aparelho	579 mm
--	--------

Largura da parte da frente do aparelho	594 mm
---	--------

Largura da parte de trás do aparelho	558 mm
---	--------

Profundidade do aparelho	561 mm
Profundidade de encastre do aparelho	540 mm
Profundidade com a porta aberta	1007 mm
Dimensão mínima da abertura de ventilação. Abertura localizada na parte inferior traseira	560x20 mm
Comprimento do cabo de alimentação elétrica. O cabo sai pelo canto traseiro direito	1100 mm
Parafusos de montagem	4x25 mm

2.2 Ligação elétrica



AVISO!

Risco de incêndio e choque elétrico.

- Todas as ligações elétricas devem ser efetuadas por um electricista qualificado.
- O aparelho tem de ficar ligado à terra.
- Certifique-se de que os parâmetros indicados na placa de características são compatíveis com as características da alimentação elétrica.
- Utilize sempre uma tomada devidamente instalada e à prova de choques elétricos.
- Não utilize adaptadores de tomadas duplas ou triplas, nem cabos de extensão.
- Certifique-se de que não danifica a ficha o cabo de alimentação elétrica. Se for necessário substituir o cabo de alimentação, esta operação deve ser efetuada pelo nosso Centro de Assistência Técnica.
- Não permita que algum cabo eléctrico toque na porta do aparelho ou no nicho abaixo do aparelho, especialmente quando a porta estiver quente.

- As protecções contra choques eléctricos das peças isoladas e não isoladas devem estar fixas de modo a não poderem ser retiradas sem ferramentas.
- Ligue a ficha à tomada eléctrica apenas no final da instalação. Certifique-se de que a ficha fica acessível após a instalação.
- Se a tomada eléctrica estiver solta, não ligue a ficha.
- Não puxe o cabo de alimentação para desligar o aparelho. Puxe sempre a ficha.
- disjuntores de protecção, fusíveis (os fusíveis de rosca devem ser retirados do suporte), diferenciais e contactores.
- A instalação eléctrica deve possuir um dispositivo de isolamento que lhe permita desligar o aparelho da corrente eléctrica em todos os pólos. O dispositivo de isolamento deve ter uma abertura de contacto com uma largura mínima de 3 mm.
- Este aparelho é fornecido com ficha e com cabo de alimentação.

Tipos de cabos aplicáveis para instalação ou substituição para a Europa:

H07 RN-F, H05 RN-F, H05 RRF, H05 VV-F, H05 V2V2-F (T90), H05 BB-F

Para informações sobre a secção do cabo, consulte a potência total na placa de características. Também pode consultar a tabela:

Potência total (W)	Secção do cabo (mm ²)
máximo de 1380	3 x 0.75
máximo de 2300	3 x 1
máximo de 3680	3 x 1.5

O cabo de terra (cabo verde/amarelo) tem de ser 2 cm mais comprido do que os cabos de fase e neutro (cabos azul e castanho).



2.3 Utilização



AVISO!

Risco de ferimentos, queimaduras, choque elétrico ou explosão.

- Este aparelho destina-se apenas a uso doméstico.
- Não altere as especificações deste aparelho.
- Certifique-se de que as aberturas de ventilação não ficam obstruídas.
- Não deixe o aparelho a funcionar sem vigilância.
- Desative o aparelho após cada utilização.
- Tenha cuidado sempre que abrir a porta do aparelho quando ele estiver a funcionar. Pode sair ar muito quente.
- Não utilize o aparelho com as mãos húmidas ou se ele estiver em contacto com água.
- Não exerça pressão sobre a porta se ela estiver aberta.
- Não utilize o aparelho como superfície de trabalho ou armazenamento.
- Abra a porta do aparelho com cuidado. A utilização de ingredientes com álcool pode provocar uma mistura de álcool e ar.
- Evite que faíscas ou chamas entrem em contacto com o aparelho quando abrir a porta.
- Não coloque produtos inflamáveis, ou objetos molhados com produtos inflamáveis, no interior, perto ou em cima do aparelho.



AVISO!

Risco de danos no aparelho.

- Para evitar danos ou descoloração do esmalte:
 - Não coloque recipientes de ir ao forno ou outros objetos diretamente sobre o fundo da cavidade do aparelho.
 - Não coloque folha de alumínio diretamente sobre o fundo da cavidade do aparelho.
 - Não verta água diretamente sobre o aparelho quando ele estiver quente.
 - Não coloque pratos ou alimentos húmidos no aparelho após acabar de cozinhar.
 - Tenha cuidado quando remover ou instalar os acessórios.

- A eventual descoloração do esmalte ou do aço inoxidável não afeta o desempenho do aparelho.
- Utilize um recipiente profundo quando cozer bolos muito húmidos. Caso contrário, os sucos da fruta podem provocar manchas permanentes.
- Este aparelho serve apenas para cozinhar. Não pode ser usado para outras funções como, por exemplo, aquecimento de divisões.
- Cozinhe sempre com a porta do forno fechada.
- Se o aparelho ficar instalado atrás de uma porta de armário, nunca feche a porta com o aparelho em funcionamento. Se a porta ficar fechada, poderá ocorrer acumulação de calor e humidade que podem danificar o aparelho, o móvel e o piso. Não feche a porta do armário enquanto o aparelho não tiver arrefecido totalmente após uma utilização.

2.4 Manutenção e limpeza



AVISO!

Risco de ferimentos, incêndio e danos no aparelho.

- Antes de qualquer ação de manutenção, desative o aparelho e desligue a ficha da tomada elétrica.
- Certifique-se de que o aparelho está frio. Existe o risco de quebra dos painéis de vidro.
- Substitua imediatamente os painéis de vidro se estiverem danificados. Contacte um Centro de Assistência Técnica Autorizado.
- Tenha cuidado quando remover a porta do aparelho. A porta é pesada!
- Limpe o aparelho com regularidade para evitar que o material da superfície se deteriore.
- Limpe o aparelho com um pano macio e húmido. Utilize apenas detergentes

neutros. Não utilize produtos abrasivos, esfregões, solventes ou objetos metálicos.

- Se utilizar um spray para forno, siga as instruções de segurança da embalagem.

2.5 Iluminação interna



AVISO!

Risco de choque elétrico.

- Relativamente à(s) lâmpada(s) no interior deste produto e às lâmpadas sobressalentes vendidas separadamente: Estas lâmpadas destinam-se a suportar condições físicas extremas em eletrodomésticos, tais como temperatura, vibração, humidade, ou destinam-se a sinalizar informação relativamente ao estado operacional do aparelho. Não se destinam a ser utilizadas em outras aplicações e não se adequam à iluminação de espaços domésticos.
- Utilize apenas lâmpadas com as mesmas especificações.

2.6 Assistência

- Contacte um Centro de Assistência Técnica Autorizado se for necessário reparar o aparelho.
- Utilize apenas peças de substituição originais.

2.7 Eliminação



AVISO!

Risco de ferimentos ou asfixia.

- Desligue o aparelho da alimentação elétrica.
- Corte o cabo de alimentação eléctrica do aparelho e elimine-o.
- Remova o trinco da porta para evitar que crianças ou animais de estimação fiquem presos no aparelho.

3. INSTALAÇÃO



AVISO!
Consulte os capítulos relativos à segurança.

3.1 Encastre

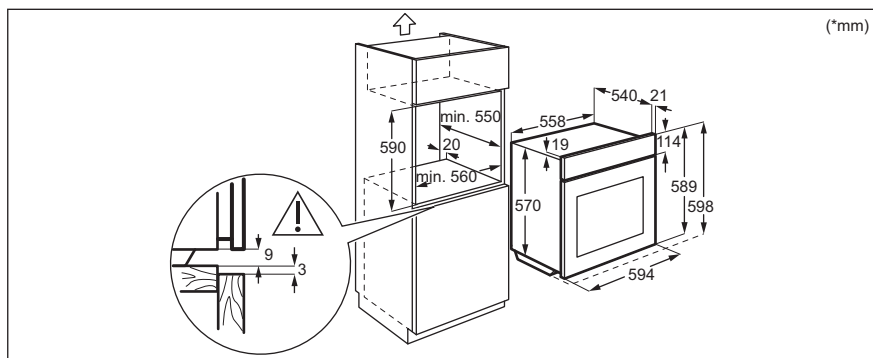
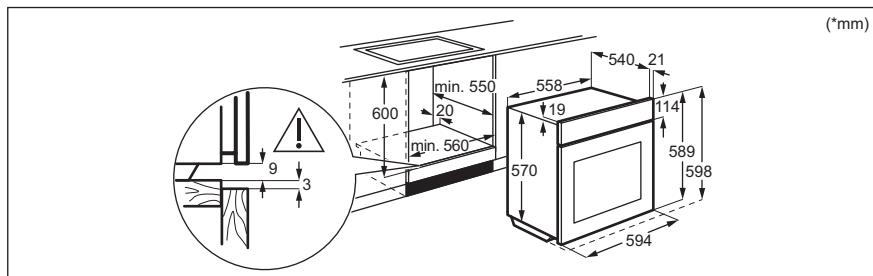

3.2 Fixação do forno no armário

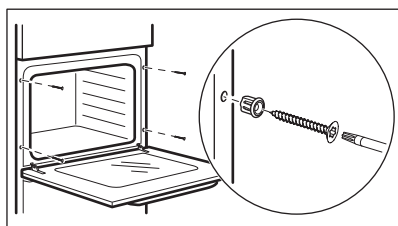

4. DESCRIÇÃO DO PRODUTO

4.1 Visão geral

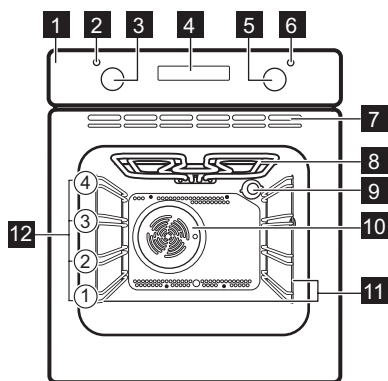

- 1 Painel de controlo
- 2 Lâmpada/símbolo de alimentação
- 3 Botão para as funções de aquecimento do forno
- 4 Visor
- 5 Botão de controlo (para a temperatura)
- 6 Símbolo / indicador de temperatura
- 7 Saídas de ar para a ventoinha de arrefecimento
- 8 Elemento de aquecimento
- 9 Lâmpada
- 10 Ventilador
- 11 Apoio para prateleira, removível
- 12 Posições de prateleira

4.2 Acessórios

- **Prateleira em grelha**
Para recipientes, formas de bolo, assados.

- **Tabuleiro para assar**
Para bolos e biscoitos.

5. PAINEL DE COMANDOS

5.1 Campos/Botões do sensor

—	Para selecionar o tempo.
⌚	Para selecionar uma função de relógio.
+	Para selecionar o tempo.

5.2 Visor

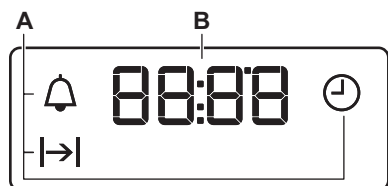

- A. Funções de relógio
- B. Temporizador

6. ANTES DA PRIMEIRA UTILIZAÇÃO



AVISO!

Consulte os capítulos relativos à segurança.

6.1 Antes da primeira utilização

O forno pode emitir algum odor e fumo durante o pré-aquecimento. Certifique-se de que o espaço é ventilado.



Passo 1



Passo 2



Passo 3

Acertar o relógio

1. - prima para definir o tempo. Após cerca de 5 segundos, o piscar pára e o visor mostra o tempo

Limpeza do forno

1. Remova todos os acessórios e apoios para prateleiras amovíveis do forno.
2. Limpe o forno e os acessórios com um pano macio, água morna e um detergente suave.

Pré-aqueça o forno vazio

1. Regule a temperatura máxima para a função. .
Tempo: 1 h.
2. Regule a temperatura máxima para a função. .
Tempo: 15 min.
3. Regule a temperatura máxima para a função. .
Tempo: 15 min.

Desligue o forno e aguarde até estar frio. Coloque os acessórios e apoios de prateleiras amovíveis do forno.

7. UTILIZAÇÃO DIÁRIA



AVISO!

Consulte os capítulos relativos à segurança.

7.1 Como definir: Função de aquecimento

Passo 1 Rode o botão para as funções de aquecimento para selecionar uma função de aquecimento.

Passo 2 Rode o botão de controlo para selecionar a temperatura.

Passo 3 Quando a cozedura terminar, rode os botões para a posição off (desligado) para desligar o forno.

7.2 Tipos de aquecimento

Tipo de aquecimento - Aplicação

0

O forno está desligado.

Posição off (desligado)



Luz

Para ativar a lâmpada:



Aquecimento Ventilado

Para cozer em até duas posições de prateleira ao mesmo tempo e para secar alimentos. Defina a temperatura do forno entre 20 °C - 40 °C a menos do que Cozedura Convencional.

Tipo de aquecimento Aplicação



Ventilado com Resistência

Esta função foi concebida para poupar energia durante o cozinhado. Quando utilizar esta função, a temperatura na cavidade pode diferir a temperatura definida. A potência do aquecimento pode ser reduzida. Para mais informações consulte o capítulo "Utilização diária", notas sobre: Ventilado com Resistência.



Aquecimento inferior

Para cozer bolos com bases esmalçadas e conservar alimentos.



Descongelar

Para descongelar alimentos (legumes e fruta). O tempo de descongelação depende da quantidade e do tamanho dos alimentos congelados.



Grelhador

Para grelhar alimentos finos e tostar pão.



Grelhador rápido

Para grelhar alimentos finos em grandes quantidades e tostar pão.

Tipo de aquecimento Aplicação



Turbo Grill

Para assar peças de carne grandes ou aves com ossos numa posição da prateleira. Para fazer gratinados e alourar.



Cozedura Convencional

Para cozer e assar pratos numa posição de prateleira.

7.3 Notas sobre: Ventilado com Resistência

Esta função foi utilizada para cumprir com os requisitos de classe de eficiência energética e design ecológico de acordo com as normas EU 65/2014 e EU 66/2014. Testes de acordo com a norma EN 60350-1.

A porta do forno deve estar fechada durante a cozedura para que a função não seja interrompida e o forno funcione com a mais alta eficiência energética possível.

Para instruções de cozedura, consulte o capítulo "Sugestões e dicas", Ventilado com Resistência. Para recomendações gerais sobre poupança de energia, consulte o capítulo "Eficiência energética", Poupança de energia.

8. FUNÇÕES DE RELÓGIO

8.1 Funções de relógio

Função de relógio

Aplicação



Hora do dia

Para definir, alterar ou verificar a hora do dia.



Duração

Para definir o tempo de funcionamento do forno.





Conta-Minutos

Para definir uma contagem decrescente. Esta função não afeta o funcionamento do forno. Pode regular esta função a qualquer momento, mesmo com o forno desligado.

8.2 Como definir: Funções de relógio



Como definir: Hora do dia



 – fica a piscar quando ligar o forno à corrente elétrica depois de uma falha de corrente ou se o temporizador não estiver configurado.

 ,  – premir para definir a hora.

A luz intermitente para depois de cerca de 5 segundos e o visor mostra a hora.

Como alterar: Hora do dia

Passo 1  – premir repetidamente para alterar a hora do dia.  – começa a piscar.

Passo 2  ,  – premir para definir a hora.

A luz intermitente para depois de cerca de 5 segundos e o visor mostra a hora.

Como definir: Duração

Passo 1 Selecionar a função do forno e a temperatura.

Passo 2  – prima repetidamente.  – começa a piscar.

Passo 3  ,  – premir para definir a duração.

O visor mostra: .



 – pisca quando o tempo definido terminar. O sinal soa e o forno desliga.

Passo 4 Premir qualquer botão para parar o sinal.

Passo 5 Rodar os botões para a posição de desligado.

Como definir: Conta-Minutos

Passo 1  – prima repetidamente.  – começa a piscar.

Passo 2  ,  – premir para definir a hora.

A função começa automaticamente após 5 segundos.

É emitido um sinal sonoro quando o tempo definido terminar.

Passo 3 Premir qualquer botão para parar o sinal.

Passo 4 Rodar os botões para a posição de desligado.

Como cancelar: Funções de relógio

Passo 1  – premir repetidamente até o símbolo da função do relógio começar a piscar.

Passo 2 Manter premido: .

A função do relógio desliga após alguns segundos.

9. UTILIZAR OS ACESSÓRIOS



AVISO!

Consulte os capítulos relativos à segurança.

9.1 Inserir acessórios

Um pequeno entalhe na parte inferior aumenta a segurança. Estes entalhes são

também dispositivos anti-inclinação. A armação elevada à volta da prateleira impede que os recipientes deslizem para fora da prateleira.

Prateleira em grelha:

Introduza a prateleira entre as barras-guia dos apoios para prateleiras e certifique-se de que os pés de apoio ficam para baixo.

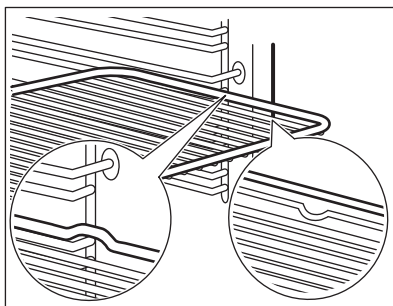

Tabuleiro para assar:

Introduza o tabuleiro entre as barras-guia do apoio para prateleiras.

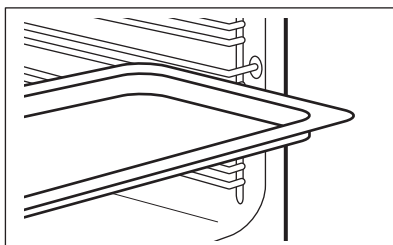

Prateleira em grelha, Tabuleiro para assar:

Introduza o tabuleiro entre as barras-guia dos apoios para prateleiras e a prateleira em grelha sobre as barras imediatamente acima.

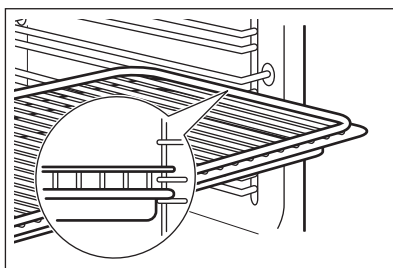

10. FUNÇÕES ADICIONAIS

10.1 Ventoinha de arrefecimento

Quando o forno está a funcionar, a ventoinha de arrefecimento é ativada automaticamente para manter as superfícies do forno frias. Se desligar o forno, a ventoinha de arrefecimento pode continuar a funcionar até o forno arrefecer.

10.2 Termóstato de segurança

Se o forno for utilizado incorretamente ou tiver alguma anomalia, pode ocorrer um

sobreaquecimento perigoso. Para evitar isso, o forno possui um termóstato de segurança que corta a alimentação elétrica. O forno volta a ativar-se automaticamente quando a temperatura baixar.

11. SUGESTÕES E DICAS



Consulte os capítulos relativos à segurança.

11.1 Recomendações para cozinhar

O forno possui quatro posições de prateleira.

Conte as posições de prateleira a partir do fundo do forno.

O forno pode ter um processo para cozer ou assar diferente do forno que utilizava anteriormente. As tabelas em baixo indicam regulações de temperatura, tempos de cozedura e posições de prateleira para algumas receitas comuns.

Se não encontrar as regulações para alguma receita específica, procure uma semelhante.

O forno possui um sistema especial que faz circular o ar e renova constantemente o vapor. Este sistema permite cozinhar num ambiente a vapor e manter os alimentos macios por dentro e estaladiços por fora. Diminui o tempo de cozedura e o consumo de energia.

Cozer bolos

Não abra a porta do forno até ter decorrido 3/4 do tempo de cozedura.

Se utilizar dois tabuleiros para assar em simultâneo, mantenha um nível vazio entre os mesmos.

Cozinhar carne e peixe

Deixe a carne repousar cerca de 15 minutos antes de a cortar, para não perder os sucos.







Para evitar demasiado fumo no forno quando assar, coloque um pouco de água no tabuleiro para grelhar. Para evitar a condensação de fumo, acrescente água sempre que ele seque.

Tempos de cozedura







Os tempos de cozedura dependem do tipo de alimento, da consistência e do volume.

No início, monitorize o desempenho quando cozinhar. Quando utilizar este aparelho, procure as melhores regulações (grau de cozedura, tempo de cozedura, etc.) para os seus recipientes e para as suas receitas e quantidades.







11.2 Fazer bolos e assar

BOLOS	Cozedura Convencional		Aquecimento Ventilado		 (min)	
	 (°C)		 (°C)			
Receitas batidas	170	2	160	2 (1 e 3)	45 - 60	Forma de bolo
Massa amanteigada	170	2	160	2 (1 e 3)	24 - 34	Forma de bolo
Cheesecake butter-milk	170	1	160	2	60 - 80	Forma de bolo, Ø 26 cm
Strudel	175	2	150	2	60 - 80	Tabuleiro para assar
Torta de compota	170	2	160	2	30 - 40	Forma de bolo, Ø 26 cm
Bolo de frutas	170	2	155	2	60 - 70	Forma de bolo, Ø 26 cm
Bolo-rei / Bolo de fruta rico	170	2	160	2	50 - 60	Forma de bolo, Ø 20 cm
Bolo de ameixa, pré-aqueça o forno vazio	170	2	160	2	50 - 60	Forma retangular
Biscoitos, pré-aqueça o forno vazio	150	3	150	3	20 - 30	Tabuleiro para assar
Merengue	100	3	100	3	90 - 120	Tabuleiro para assar
Pãezinhos, pré-aqueça o forno vazio	190	3	180	3	15 - 20	Tabuleiro para assar
Massa para éclairs e profiteroles, pré-aqueça o forno vazio	190	3	180	3	25 - 35	Tabuleiro para assar
Tartes	180	3	170	2	45 - 70	Forma de bolo, Ø 20 cm
Bolo de duas camadas	180	1 ou 2	170	2	40 - 55	Forma de bolo, Ø 20 cm

Pré-aqueça o forno vazio.





 PÃO E PIZZA	Cozedura Convencional		Aquecimento Ventilado		 (min)	
	 (°C)		 (°C)			
Pão branco, 1 - 2 unidades, 0,5 kg cada	190	1	190	1	60 - 70	-
Pão de centeio, não é necessário pré-aquecer	190	1	180	1	30 - 45	Forma retangular
Pãezinhos, 6 - 8 pãezinhos	190	2	180	2 (1 e 3)	25 - 40	Tabuleiro para assar
Pizza massa fina	190	1	190	1	20 - 30	Tabuleiro para grelhar
Scones	200	3	190	2	10 - 20	Tabuleiro para assar





Utilize uma forma de bolo.







 FLANS	Cozedura Convencional		Aquecimento Ventilado		 (min)
	 (°C)		 (°C)		
Empadas	180	2	180	2	40 - 50
Flan de vegetais	200	2	175	2	45 - 60
Quiches	190	1	190	1	40 - 50
Lasanha	200	2	200	2	25 - 40
Canelones	200	2	190	2	25 - 40
Pudim Yorkshire, 6 formas de pudim, pré-aqueça o forno vazio	220	2	210	2	20 - 30







Utilize a segunda posição da prateleira.

Utilize a prateleira em grelha.

 CARNE	Cozedura Convencional	Aquecimento Ventilado	 (min)
	 (°C)	 (°C)	
Carne De Vaca	200	190	50 - 70
Lombo de porco	180	180	90 - 120
Vitela	190	175	90 - 120

 CARNE	Cozedura Convencional	Aquecimento Ventilado	 (min)
	 (°C)	 (°C)	
Carne assada, mal passada	210	200	44 - 50
Carne assada, média	210	200	51 - 55
Carne assada, bem passada	210	200	55 - 60

 CARNE	Cozedura Convencional		Aquecimento Ventilado		 (min)
	 (°C)		 (°C)		
Pá de porco, com courato	180	2	170	2	120 - 150
Perna de porco, 2 unidades	180	2	160	2	100 - 120
Perna de borrego	190	2	190	2	110 - 130
Frango inteiro	200	2	200	2	70 - 85
Peru inteiro	180	1	160	1	210 - 240
Pato inteiro	175	2	160	2	120 - 150
Ganso inteiro	175	1	160	1	150 - 200
Coelho, cortado em pedaços	190	2	175	2	60 - 80
Lebre, cortada em pedaços	190	2	175	2	150 - 200
Faisão inteiro	190	2	175	2	90 - 120

 PEIXE	Cozedura Convencional		Aquecimento Ventilado		 (min)
	 (°C)		 (°C)		
Truta / Dourada, 3 - 4 peixes	190	2	175	2 (1 e 3)	40 - 55
Atum / Salmão, 4 - 6 filetes	190	2	175	2 (1 e 3)	35 - 60

11.3 Grelhador

Pré-aqueça o forno vazio.

Utilize a terceira posição de prateleira.

Defina a temperatura para 250 °C.



GRELHAR



(kg)



(min)
1.º lado



(min)
2.º lado

	(kg)	(min) 1.º lado	(min) 2.º lado
Bifes do lombo, 4 unidades	0,8	12 - 15	12 - 14
Bife de vaca, 4 unidades	0,6	10 - 12	6 - 8
Salgados, 8	-	12 - 15	10 - 12
Costeleta de porco, 4 unidades	0,6	12 - 16	12 - 14
1/2 Frango, 2	1	30 - 35	25 - 30
Espetadas, 4	-	10 - 15	10 - 12
Peito de frango, 4 unidades	0,4	12 - 15	12 - 14
Hambúrgueres, 6	0,6	20 - 30	-
Filete de peixe, 4 unidades	0,4	12 - 14	10 - 12
Sandes tostadas, 4 - 6	-	5 - 7	-
Tosta, 4 - 6	-	2 - 4	2 - 3

11.4 Turbo Grill

Pré-aqueça o forno vazio.

Regule a temperatura para 200 °C.

Utilize a terceira posição de prateleira.



(kg)







(min)

1.º lado

2.º lado

	(kg)	1.º lado	2.º lado
Rolo de carne, peru	1	30 - 40	20 - 30
1/2 Frango, 2	1	25 - 30	20 - 30
Coxas de frango, 6 unidades	-	15 - 20	15 - 18
Codornizes, 4 unidades	0,5	25 - 30	20 - 25
Gratinado de legumes	-	20 - 25	-
Vieiras	-	15 - 20	-
Cavala, 2 - 4	-	15 - 20	10 - 15
Peixe em posta, 4 - 6	0,8	12 - 15	8 - 10

11.5 Descongelar

	 (kg)	 Tempo de descongelamento (min.)	 Tempo extra de descongelamento (min.)	
Frango	1	100 - 140	20 - 30	Coloque o frango sobre um pires virado ao contrário e este sobre um prato grande. Vire a meio do tempo.
Carne	1	100 - 140	20 - 30	Vire a meio do tempo.
	0,5	90 - 120		
Natas	2 x 0,2	80 - 100	10 - 15	Também é possível bater as natas quando ainda estão ligeiramente congeladas.
Truta	0,15	25 - 35	10 - 15	-
Morangos	0,3	30 - 40	10 - 20	-
Manteiga	0,25	30 - 40	10 - 15	-
Gateau	1,4	60	60	-

11.6 Ventilado com Resistência - acessórios recomendados

Utilize os tabuleiros e recipientes escuros e não refletores. Têm melhor absorção do calor do que a loiça de cor clara e refletora.



Forma para pizza

Escuro, não refletor
28 cm de diâmetro



Assadeira

Escuro, não refletor
26 cm de diâmetro



Formas individuais

Vitrocêrâmica
8 cm de diâmetro,
5 cm de altura

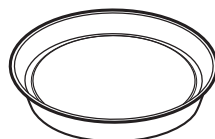











Forma com base para flan

Escuro, não refletor
28 cm de diâmetro

11.7 Ventilado com Resistência







Para obter os melhores resultados, siga as sugestões indicadas na tabela abaixo.

		 (°C)		 (min.)
Pastéis doces, 12 unidades	tabuleiro para assar ou tabuleiro para recolha de gorduras	180	2	35 - 40
Pasteis, 9 unidades	tabuleiro para assar ou tabuleiro para recolha de gorduras	180	2	35 - 40
Pizza, congelada, 0,35 kg	prateleira em grelha	220	2	35 - 40
Torta suíça	tabuleiro para assar ou tabuleiro para recolha de gorduras	170	2	30 - 40
Brownie	tabuleiro para assar ou tabuleiro para recolha de gorduras	180	2	30 - 40
Soufflé, 6 unidades	formas pequenas de cerâmica na prateleira em grelha	200	3	30 - 40
Base de flan de massa batida	forma de base de flan na prateleira em grelha	170	2	20 - 30
Bolo de duas camadas	assadeira na prateleira em grelha	170	2	35 - 45
Peixe escalfado, 0,3 kg	tabuleiro para assar ou tabuleiro para recolha de gorduras	180	3	35 - 45
Peixe, inteiro (até 1Kg), 0,2 kg	tabuleiro para assar ou tabuleiro para recolha de gorduras	180	3	35 - 45
Filete de peixe, 0,3 kg	forma de piza na prateleira em grelha	180	3	35 - 45
Carne escalfada, 0,25 kg	tabuleiro para assar ou tabuleiro para recolha de gorduras	200	3	40 - 50
Shashlik, 0,5 kg	tabuleiro para assar ou tabuleiro para recolha de gorduras	200	3	25 - 35
Biscoitos, 16 unidades	tabuleiro para assar ou tabuleiro para recolha de gorduras	180	2	20 - 30
Biscoitos de amêndoa, 20 unidades	tabuleiro para assar ou tabuleiro para recolha de gorduras	180	2	40 - 45
Queques, 12 unidades	tabuleiro para assar ou tabuleiro para recolha de gorduras	170	2	30 - 40
Pastelaria salgada, 16 unidades	tabuleiro para assar ou tabuleiro para recolha de gorduras	170	2	35 - 45
Biscoitos de massa fina, 20 unidades	tabuleiro para assar ou tabuleiro para recolha de gorduras	150	2	40 - 50
Tarteletes, 8 unidades	tabuleiro para assar ou tabuleiro para recolha de gorduras	170	2	20 - 30
Legumes, escalfados, 0,4 kg	tabuleiro para assar ou tabuleiro para recolha de gorduras	180	3	35 - 40
Omeleta de legumes	forma de piza na prateleira em grelha	200	3	30 - 45

		 (°C)		 (min.)
Legumes mediterrânicos, 0,7 kg	tabuleiro para assar ou tabuleiro para recolha de gorduras	180	4	35 - 40

11.8 Informação para testes

Testes de acordo com a norma IEC 60350-1.

				 (°C)	 (min)	
Bolos pequenos, 20 por tabuleiro	Cozedura Convencional	Tabuleiro para assar	3	170	20 - 30	-
Tarte de maçã, 2 formas, Ø 20 cm	Cozedura Convencional	Prateleira em grelha	1	170	80 - 120	-
Pão-de-ló, forma de bolo de Ø26 cm	Cozedura Convencional	Prateleira em grelha	2	170	35 - 45	-
Massa amanteigada	Cozedura Convencional	Tabuleiro para assar	3	150	20 - 35	Pré-aqueça o forno durante 10 minutos.
Tosta, 4 - 6 unidades	Grelhador	Prateleira em grelha	3	máx.	2 - 4 minutos para o primeiro lado; 2 - 3 minutos para o segundo lado	Pré-aqueça o forno durante 3 minutos.
Hambúrguer de vaca, 6 unidades, 0,6 kg	Grelhador	Prateleira em grelha e tabuleiro de recolha de gorduras	3	máx.	20 - 30	Coloque a prateleira em grelha no terceiro nível e o tabuleiro de recolha de gorduras no segundo nível do forno. Vire os alimentos a meio do tempo de cozedura. Pré-aqueça o forno durante 3 minutos.

12. MANUTENÇÃO E LIMPEZA



AVISO!

Consulte os capítulos relativos à segurança.

12.1 Notas sobre a limpeza



Agentes de limpeza

Limpe a parte da frente do forno com um pano macio com água morna e um detergente suave. Limpe e verifique a junta da porta em torno da moldura da cavidade.

Utilize uma solução de limpeza para limpar as superfícies metálicas.

Limpe manchas com um detergente suave.



Utilização diária

Limpe a cavidade após cada utilização. A acumulação de gordura ou outros resíduos pode provocar incêndios.

Pode ocorrer condensação de humidade no forno ou nos painéis de vidro da porta. Para diminuir a condensação, deixe o forno funcionar durante 10 minutos antes da cozedura. Não guarde alimentos no forno durante mais de 20 minutos. Seque a cavidade com um pano macio após cada utilização.



Acessórios

Limpe todos os acessórios do forno após cada utilização e deixe-os secar. Utilize um pano macio com água morna e um detergente suave. Não lave os acessórios na máquina de lavar loiça.

Não limpe acessórios anti-aderentes utilizando detergentes abrasivos ou objetos afiados.

12.2 Como remover: Apoios para prateleiras

Retire os apoios para prateleiras para limpar o forno.

Passo 1 Desligue o forno e aguarde até estar frio.

Passo 2 Puxe a parte da frente do apoio para prateleiras para fora da parede lateral.

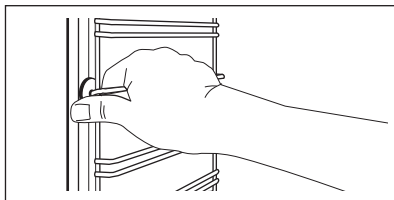

Passo 3 Puxe a parte de trás do apoio para prateleiras para fora da parede lateral e retire-o.

Passo 4 Instale os apoios para grelhas na sequência inversa.

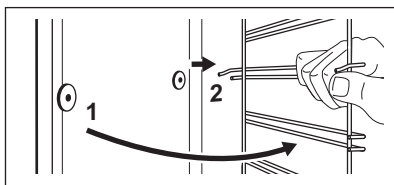

12.3 Como remover e instalar: Porta

A porta do forno tem dois painéis de vidro. Pode remover a porta do forno e o painel de vidro interno para limpar. Leia todas as instruções sobre "Remoção e instalação da porta" antes de remover os painéis de vidro.

**CUIDADO!**

Não utilize o forno sem os painéis de vidro.

Passo 1 Abra completamente a porta e segure em ambas as dobradiças.

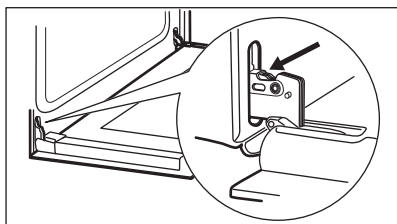

Passo 2 Levante e rode as alavancas totalmente em ambas as dobradiças.

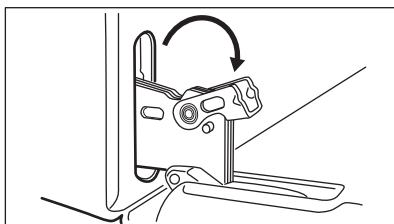

Passo 3 Feche a porta do forno até meio, parando na primeira posição de abertura. Em seguida, levante e puxe a porta e remova-a dos encaixes.

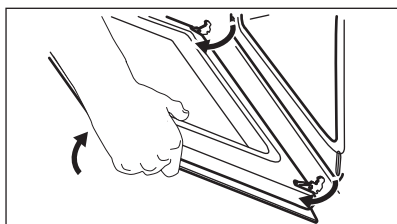

Passo 4 Coloque a porta num pano macio numa superfície estável e liberte o sistema de bloqueio para remover o painel de vidro interno.

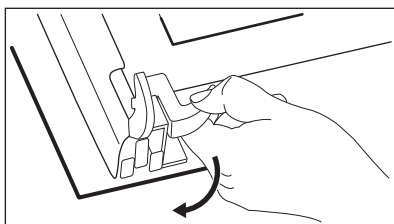

Passo 5 Rode os fixadores em 90° e retire-os dos respectivos alojamentos

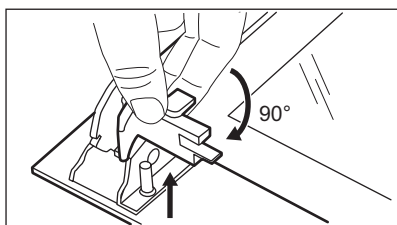

Passo 6 Comece por levantar o painel de vidro com cuidado e depois retire-o.

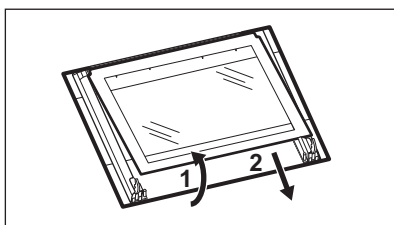

Passo 7 Limpe os painéis de vidro com água e sabão. Seque cuidadosamente os painéis de vidro. Não lave os acessórios na máquina de lavar loiça.

Passo 8 Após a limpeza, instale o painel de vidro e a porta do forno.

Quando instalado corretamente, o friso para porta emite um clique. Certifique-se de que instala o painel de vidro interior corretamente nos respectivos encaixes.

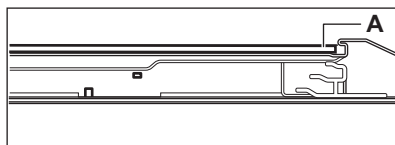

12.4 Como substituir: Lâmpada



AVISO!

Risco de choque elétrico.
A lâmpada pode estar quente.

Antes de substituir a lâmpada:

Passo 1	Passo 2	Passo 3
Desligue o forno. Aguarde até que o forno esteja frio.	Desligue o forno da corrente elétrica.	Coloque um pano no fundo da cavidade.

Lâmpada posterior

Passo 1	Rode a proteção de vidro para a retirar.
Passo 2	Limpe a proteção de vidro.
Passo 3	Substitua a lâmpada por uma lâmpada adequada, resistente ao calor até 300 °C.
Passo 4	Instale a proteção de vidro.

13. RESOLUÇÃO DE PROBLEMAS



AVISO!

Consulte os capítulos relativos à segurança.

13.1 O que fazer se...

Em quaisquer casos não incluídos nesta tabela, contacte um centro de assistência autorizado.

Problema	Certifique-se de que...
O forno não aquece.	O disjuntor está desligado.
A junta da porta está danificada.	Não utilize o forno. Contacte um Centro de Assistência Técnica Autorizado.
O visor apresenta "12.00".	Houve uma falha de corrente elétrica. Definir a hora do dia.

Problema	Certifique-se de que...
----------	-------------------------

A lâmpada não funciona. A lâmpada está fundida.

13.2 Dados para a Assistência Técnica

Se não conseguir encontrar uma solução para o problema, contacte o concessionário ou um Centro de Assistência Técnica Autorizado.

Os dados de contacto do Centro de Assistência Técnica encontram-se na placa de características. A placa de características está na moldura frontal da cavidade do forno. Não remova a placa de características da cavidade do forno.

Recomendamos que anote os dados aqui:

Modelo (MOD.)

Recomendamos que anote os dados aqui:

Número do produto (PNC)

Número de série (S.N.)

14. EFICIÊNCIA ENERGÉTICA

14.1 Informação de produto e folha de informação de produto*

Nome do fornecedor	Zanussi
Identificação do modelo	ZOHEE2X1 944068087 ZOHIE2X1 944068089
Índice de eficiência energética	94,9
Classe de eficiência energética	A
Consumo de energia com uma carga normal, modo convencional	0,83 kWh/ciclo
Consumo de energia com uma carga normal, modo ventilado	0,75 kWh/ciclo
Número de cavidades	1
Fonte de calor	Eletricidade
Volume	57 l
Tipo de forno	Forno de encastrar
Massa	ZOHEE2X1 28.6 kg
	ZOHIE2X1 28.6 kg

* Para a União Europeia de acordo com os Regulamentos 65/2014 e 66/2014 da UE.

Para a República da Bielorrússia de acordo com a norma STB 2478-2017, Anexo G; STB 2477-2017, Anexos A e B.

Para a Ucrânia de acordo com a norma 568/32020.

A classe de eficiência energética não se aplica na Rússia.

EN 60350-1 - Aparelhos elétricos domésticos para cozinhar - Parte 1: Placas, fornos, fornos a vapor e grelhadores - Métodos de medição do desempenho.

14.2 Poupança de energia



O forno possui funções que ajudam a poupar energia nos cozinhados de todos os dias.

Certifique-se de que a porta do forno está fechada quando o forno funcionar. Não abra a porta do forno muitas vezes durante o funcionamento. Mantenha a junta da porta limpa e certifique-se de que está bem fixa na posição correcta.

Utilize recipientes de metal para melhorar a poupança de energia.

Quando possível, não pré-aqueça o forno antes de cozinhar.

Quando preparar vários pratos de uma vez, reduza ao mínimo possível os intervalos entre cozeduras.

Cozinhar com a ventoinha

Sempre que possível, utilize as funções de cozedura que utilizam a ventoinha, para poupar energia.

Calor residual

Quando a duração da cozedura for superior a 30 min, reduza a temperatura do forno para 3 a 10 min no mínimo antes do fim da

cozedura. O calor residual no interior do forno concluirá a cozedura.

Utilize o calor residual para aquecer outros pratos.

Manter os alimentos quentes

Para utilizar o calor residual para manter uma refeição quente, seleccione a regulação de temperatura mais baixa possível.

Ventilado com Resistência

Função concebida para poupar energia durante a cozedura.

15. PREOCUPAÇÕES AMBIENTAIS

Recicle os materiais que apresentem o símbolo . Coloque a embalagem nos contentores indicados para reciclagem. Ajude a proteger o ambiente e a saúde pública através da reciclagem dos aparelhos eléctricos e electrónicos. Não elimine os

aparelhos que tenham o símbolo  juntamente com os resíduos domésticos. Coloque o produto num ponto de recolha para reciclagem local ou contacte as suas autoridades municipais.

VISITE NUESTRO SITIO WEB PARA:



Obtener consejos, folletos, soluciones a problemas e información de servicio y reparación:
www.zanussi.com/support

Salvo modificaciones.

CONTENIDO

1. INFORMACIÓN SOBRE SEGURIDAD.....	120
2. INSTRUCCIONES DE SEGURIDAD.....	122
3. INSTALACIÓN.....	125
4. DESCRIPCIÓN DEL PRODUCTO.....	126
5. PANEL DE MANDOS.....	126
6. ANTES DEL PRIMER USO.....	127
7. USO DIARIO.....	127
8. FUNCIONES DEL RELOJ.....	128
9. USO DE LOS ACCESORIOS.....	130
10. FUNCIONES ADICIONALES.....	131
11. CONSEJOS.....	131
12. MANTENIMIENTO Y LIMPIEZA.....	138
13. SOLUCIÓN DE PROBLEMAS.....	141
14. EFICACIA ENERGÉTICA.....	141

1. ⚠ INFORMACIÓN SOBRE SEGURIDAD

Antes de instalar y utilizar el aparato, lea atentamente las instrucciones facilitadas. El fabricante no se hace responsable de lesiones o daños producidos como resultado de una instalación o un uso incorrectos. Conserve siempre estas instrucciones en lugar seguro y accesible para futuras consultas.

1.1 Seguridad de niños y personas vulnerables

- Este aparato puede ser utilizado por niños de 8 años en adelante y personas cuyas capacidades físicas, sensoriales o mentales estén disminuidas o que carezcan de la experiencia y conocimientos suficientes para manejarlo, siempre que cuenten con las instrucciones o la supervisión sobre el uso del electrodoméstico de forma segura y comprendan los riesgos. Hay que mantener alejados del producto a los niños de menos de 8 años, así como a las

personas con minusvalías importantes y complejas, salvo que estén bajo supervisión continua.

- No deje que los niños jueguen con el aparato.
- Mantenga todo el material de embalaje fuera del alcance de los niños y deséchelo de forma adecuada.
- **ADVERTENCIA:** Mantenga a los niños y mascotas alejados del aparato cuando esté funcionando o enfriándose. Las partes accesibles se calientan durante el uso.
- Si este aparato tiene un bloqueo de seguridad para niños, debe activarlo.
- La limpieza y mantenimiento de usuario del aparato no podrán ser realizados por niños sin supervisión.

1.2 Seguridad general

- Solo un electricista cualificado puede instalar este aparato y sustituir el cable.
- **ADVERTENCIA:** El aparato y las piezas accesibles se calientan mucho durante el funcionamiento. Preste mucha atención para no tocar las resistencias.
- Utilice siempre guantes de horno cuando introduzca o retire accesorios o utensilios refractarios.
- Antes de realizar tareas de mantenimiento, desenchufe el aparato de la red eléctrica.
- **ADVERTENCIA:** Asegúrese de que el aparato está desconectado antes de reemplazar la lámpara con el fin de impedir que se produzca una descarga eléctrica.
- No utilice el aparato antes de instalarlo en la estructura empotrada.
- No utilice un limpiador a vapor para limpiar el aparato.
- No utilice limpiadores abrasivos ásperos ni rascadores de metal afilado para limpiar la puerta de cristal si no quiere arañar su superficie, lo que podría hacer que el cristal se hiciese añicos.
- Si el cable de alimentación eléctrica sufre algún daño, el fabricante, su servicio técnico autorizado o un profesional cualificado tendrán que cambiarlo para evitar riesgos eléctricos.

- Para quitar los carriles laterales, tire primero del frontal del carril y luego separe el extremo trasero de las paredes. Coloque los carriles laterales en el orden inverso.

2. INSTRUCCIONES DE SEGURIDAD

2.1 Instalación



ADVERTENCIA!

Sólo un técnico cualificado puede instalar el aparato.

- Retire todo el embalaje.
- No instale ni utilice un aparato dañado.
- Siga las instrucciones de instalación suministradas con el aparato.
- Tenga cuidado al mover el aparato, porque es pesado. Utilice siempre guantes de protección y calzado cerrado.
- No tire nunca del aparato sujetando el asa.
- Instale el aparato en un lugar seguro y adecuado que cumpla los requisitos de instalación.
- Respete siempre la distancia mínima entre el aparato y los demás electrodomésticos y mobiliario.
- Antes de montar el aparato, compruebe si la puerta del horno se abre sin limitaciones.
- El aparato dispone de un sistema de enfriamiento eléctrico. Debe utilizarse con alimentación eléctrica.

Altura mínima del armario (Altura mínima del armario debajo de la encimera)	590 (600) mm
---	--------------

Ancho del armario	560 mm
-------------------	--------

Profundidad del armario	550 (550) mm
-------------------------	--------------

Altura de la parte frontal del aparato	598 mm
--	--------

Altura de la parte trasera del aparato	579 mm
--	--------

Anchura de la parte frontal del aparato	594 mm
---	--------

Anchura de la parte trasera del aparato	558 mm
---	--------

Fondo del aparato	561 mm
-------------------	--------

Fondo empotrado del aparato	540 mm
-----------------------------	--------

Fondo con la puerta abierta	1007 mm
-----------------------------	---------

Tamaño mínimo de la abertura de ventilación. Abertura situada en la parte trasera inferior	560x20 mm
--	-----------

Longitud del cable de alimentación. El cable está en la esquina derecha de la parte trasera	1100 mm
---	---------

Tornillos de montaje	4x25 mm
----------------------	---------

2.2 Conexión eléctrica



ADVERTENCIA!

Riesgo de incendios y descargas eléctricas.

- Todas las conexiones eléctricas deben realizarlas electricistas cualificados.
- El aparato debe conectarse a tierra.
- Asegúrese de que los parámetros de la placa de características son compatibles con los valores eléctricos del suministro eléctrico.
- Utilice siempre una toma con aislamiento de conexión a tierra correctamente instalada.
- No utilice adaptadores de enchufes múltiples ni cables prolongadores.
- Asegúrese de no provocar daños en el enchufe ni en el cable de red. Si es necesario cambiar el cable de alimentación del aparato, debe hacerlo el centro de servicio técnico autorizado.
- Evite que el cable de red toque o entre en contacto con la puerta del aparato o con el hueco por debajo del aparato, especialmente mientras funciona o si la puerta está caliente.
- Los mecanismos de protección contra descargas eléctricas de componentes con corriente y aislados deben fijarse de forma que no puedan aflojarse sin utilizar herramientas.

- Conecte el enchufe a la toma de corriente únicamente cuando haya terminado la instalación. Asegúrese de tener acceso al enchufe del suministro de red una vez finalizada la instalación.
- Si la toma de corriente está floja, no conecte el enchufe.
- No desconecte el aparato tirando del cable de conexión a la red. Tire siempre del enchufe.
- Use únicamente dispositivos de aislamiento apropiados: línea con protección contra los cortocircuitos, fusibles (tipo tornillo que puedan retirarse del soporte), dispositivos de fuga a tierra y contactores.
- La instalación eléctrica debe tener un dispositivo de aislamiento que permita desconectar el aparato de todos los polos de la red. El dispositivo de aislamiento debe tener una apertura de contacto con una anchura mínima de 3 mm.
- El aparato se suministra con enchufe y cable de red.

Tipos de cables aplicables para su instalación o cambio para Europa:

H07 RN-F, H05 RN-F, H05 RRF, H05 VV-F, H05 V2V2-F (T90), H05 BB-F

En lo que respecta a la sección del cable, consulte la potencia total que figura en la placa de características. También puede consultar la tabla:

Potencia total (W)	Sección del cable (mm ²)
máximo 1380	3 x 0.75
máximo 2300	3 x 1
máximo 3680	3 x 1.5

El cable de tierra (cable verde/amarillo) debe tener 2 cm más que los cables de fase y del neutro (cables azul y marrón).



2.3 Uso del aparato



ADVERTENCIA!

Riesgo de lesiones, quemaduras y descargas eléctricas o explosiones.

- Este aparato está diseñado exclusivamente para uso doméstico.
- No cambie las especificaciones de este aparato.
- Cerciórese de que los orificios de ventilación no están obstruidos.
- No deje nunca el aparato desatendido mientras está en funcionamiento.
- Desactive el aparato después de cada uso.
- Tenga cuidado al abrir la puerta del aparato cuando éste esté en funcionamiento. Pueden liberarse vapores calientes.
- No utilice el aparato con las manos mojadas ni cuando entre en contacto con el agua.
- No ejerza presión sobre la puerta abierta.
- No utilice el aparato como superficie de trabajo ni de almacenamiento.
- Abra la puerta del aparato con cuidado. El uso de ingredientes con alcohol puede generar una mezcla de alcohol y aire.
- Procure que no haya chispas ni fuego encendido cerca cuando se abra la puerta del aparato.
- No coloque productos inflamables ni objetos mojados con productos inflamables dentro, cerca o encima del aparato.



ADVERTENCIA!

Podría dañar el aparato.

- Para evitar daños o decoloraciones del esmalte:
 - no coloque utensilios refractarios ni otros objetos directamente en la parte inferior del aparato.
 - no coloque papel de aluminio directamente en la parte inferior del aparato.
 - No ponga agua directamente en el aparato caliente.
 - No deje platos húmedos ni comida en el aparato una vez finalizada la cocción.
 - Preste especial atención al desmontar o instalar los accesorios.

- La pérdida de color del esmalte o el acero inoxidable no afecta al rendimiento del aparato.
- Utilice una bandeja honda para pasteles húmedos. Los jugos de las frutas podrían ocasionar manchas permanentes.
- Este aparato está diseñado exclusivamente para cocinar. No debe utilizarse para otros fines, por ejemplo, como calefacción.
- Cocine siempre con la puerta del horno cerrada.
- Si el aparato se instala detrás de un panel de un mueble (por ejemplo una puerta) asegúrese de que la puerta nunca esté cerrada mientras funciona el aparato. El calor y la humedad pueden acumularse detrás de un panel del armario cerrado y provocar daños al aparato, la unidad donde se encuentra o el suelo. No cierre del panel del armario hasta que el aparato se haya enfriado totalmente después de su uso.

2.4 Mantenimiento y limpieza



ADVERTENCIA!

Existe riesgo de lesiones, incendios o daños al aparato.

- Antes de proceder con el mantenimiento, apague el aparato y desconecte el enchufe de la red.
- Asegúrese de que el aparato esté frío. Los paneles de cristal pueden romperse.
- Cambie inmediatamente los paneles de cristal de la puerta que estén dañados. Póngase en contacto con el servicio técnico autorizado.
- Tenga cuidado al desmontar la puerta del aparato. ¡La puerta es muy pesada!
- Limpie periódicamente el aparato para evitar el deterioro del material de la superficie.
- Limpie el aparato con un paño suave humedecido. Utilice solo detergentes neutros. No utilice productos abrasivos,

estropajos duros, disolventes ni objetos metálicos.

- Si utiliza aerosoles de limpieza para hornos, siga las instrucciones de seguridad del envase.

2.5 Luces interiores



ADVERTENCIA!

Riesgo de descarga eléctrica.

- En cuanto a la(s) bombilla(s) de este producto y las de repuesto vendidas por separado: Estas bombillas están destinadas a soportar condiciones físicas extremas en los aparatos domésticos, como la temperatura, la vibración, la humedad, o están destinadas a señalar información sobre el estado de funcionamiento del aparato. No están destinadas a utilizarse en otras aplicaciones y no son adecuadas para la iluminación de estancias domésticas.
- Utilice solo bombillas de las mismas características .

2.6 Asistencia

- Para reparar el aparato, póngase en contacto con el centro de servicio autorizado.
- Utilice solamente piezas de recambio originales.

2.7 Eliminación



ADVERTENCIA!

Existe riesgo de lesiones o asfixia.

- Desconecte el aparato de la red.
- Corte el cable eléctrico cerca del aparato y deséchelo.
- Retire el pestillo de la puerta para evitar que los niños las mascotas queden atrapados en el aparato.

3. INSTALACIÓN



ADVERTENCIA!
Consulte los capítulos sobre seguridad.

3.1 Empotrado

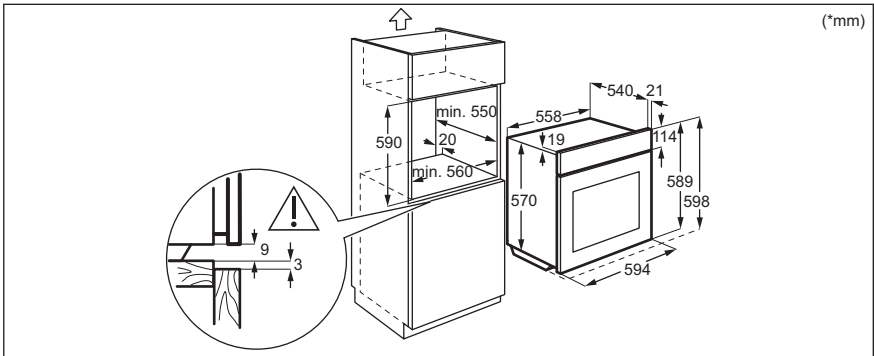
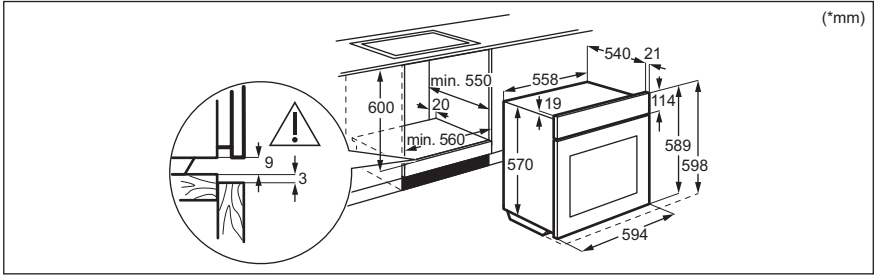

3.2 Fijación del horno al mueble

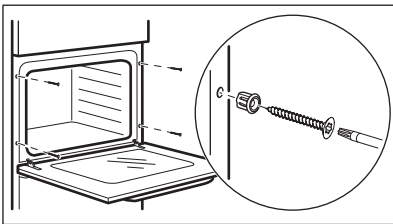

4. DESCRIPCIÓN DEL PRODUCTO

4.1 Descripción general

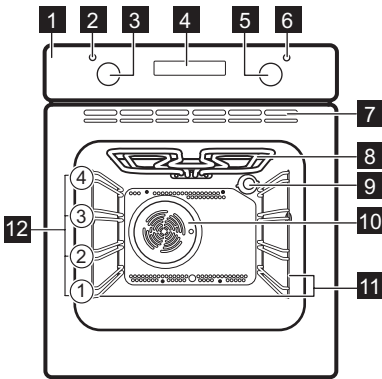

- 1 Panel de control
- 2 Piloto/símbolo de alimentación
- 3 Mando de las funciones de cocción
- 4 Pantalla
- 5 Mando de control (para la temperatura)
- 6 Indicador/símbolo de temperatura
- 7 Salidas de aire del ventilador de refrigeración
- 8 Elemento calentador
- 9 Bombilla
- 10 Ventilador
- 11 Carril de apoyo, extraíble
- 12 Niveles para las rejillas

4.2 Accesorios

- **Parrilla**
Para bandejas de horno, pastel en molde, asados.

- **Bandeja**
Para bizcochos y galletas.

5. PANEL DE MANDOS

5.1 Sensores / botones

—	Para ajustar el tiempo.
⌚	Para ajustar una función de reloj.
+	Para ajustar el tiempo.

5.2 Pantalla

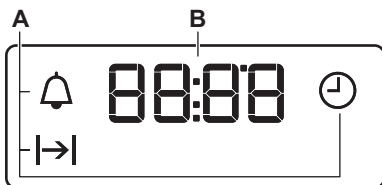

- A. Funciones del reloj
- B. Temporizador

6. ANTES DEL PRIMER USO



ADVERTENCIA!

Consulte los capítulos sobre seguridad.

6.1 Antes del primer uso

El horno puede emitir olores y humos durante el precalentamiento. Asegúrese de que la sala esté ventilada.



Paso 1

Ajuste el reloj

1. - pulse **+**, **-** para ajustar la hora. Después de unos 5 segundos, el parpadeo cesa y la pantalla indica la hora ajustada.



Paso 2



Limpie el horno

1. Retire todos los accesorios y carriles de apoyo extraíbles del horno.
2. Limpie el horno y los accesorios con un paño suave humedecido en agua templada y jabón neutro.



Paso 3

Precaliente el horno vacío

1. Seleccione la temperatura máxima para la función: . Tiempo: 1 h.
2. Seleccione la temperatura máxima para la función: . Tiempo: 15 min.
3. Seleccione la temperatura máxima para la función: . Tiempo: 15 min.

Apague el horno y espere a que esté frío. Coloque los accesorios y carriles de apoyo extraíbles en el horno.

7. USO DIARIO



ADVERTENCIA!

Consulte los capítulos sobre seguridad.

7.1 Cómo configurar: Función de cocción

Paso 1 Gire el mando del horno para seleccionar una función de cocción.

Paso 2 Gire el mando de control para seleccionar la temperatura.

Paso 3 Al terminar la cocción, gire los mandos hasta la posición de apagado para apagar el horno.

7.2 Funciones de cocción

Función de cocción

Aplicación

0

El horno está apagado.

Posición de apagado









Luz

Para encender la luz.



Aire caliente

Para hornear en hasta dos posiciones de parrilla a la vez y para secar alimentos. Ajuste la temperatura entre 20 y 40 °C menos que para Cocción convencional.

Función de cocción	Aplicación
 Horneado húmedo + ventil.	Función diseñada para ahorrar energía durante la cocción. Cuando se utiliza esta función, la temperatura del horno puede diferir de la temperatura programada. La potencia calorífica puede reducirse. Para más información, consulte el capítulo "Uso diario", Notas sobre: Horneado húmedo + ventil..
 Calor inferior	Para preparar pasteles con bases crujientes y conservar alimentos.
 Descongelar	Para descongelar alimentos (verdura y fruta). El tiempo de descongelación depende de la cantidad y tamaño de los alimentos congelados.
 Grill	Para asar al grill alimentos de poco espesor y tostar pan.
 Grill Rápido	Para asar al grill trozos finos de comida en grandes cantidades y tostar pan.
 Grill Turbo	Para asar piezas de carne grandes o aves con hueso en una posición de bandeja. Para hacer gratenes y dorar.

Función de cocción	Aplicación
 Cocción convencional	Para hornear y asar alimentos en una posición de bandeja.

7.3 Notas sobre: Horneado húmedo + ventil.



Esta función se utilizaba para cumplir con los requisitos de categoría de eficiencia energética y ecodiseño según EU 65/2014 y EU 66/2014. Pruebas conforme a EN 60350-1.

La puerta del horno debe estar cerrada durante la cocción para que la función no se interrumpa y que el horno funcione con la máxima eficiencia energética posible.

Para las instrucciones de cocción, consulte el capítulo "Consejos", Horneado húmedo + ventil.. Puede consultar recomendaciones generales para ahorrar energía en el capítulo "Eficiencia energética", bajo consumo energético.

8. FUNCIONES DEL RELOJ

8.1 Funciones del reloj

función de reloj	Aplicación
 Hora	Ajustar, modificar o comprobar la hora.
 Duración	Programar la duración del funcionamiento del horno.
 Avisador	Para configurar una cuenta atrás. Esta función no influye en el funcionamiento del horno. Puede ajustar esta función cualquier momento, incluso si el horno está apagado.

8.2 Cómo ajustar: Funciones del reloj



Cómo ajustar: Hora

 - parpadea al conectar el horno a la corriente eléctrica si ha habido un corte de corriente o si no está ajustado el temporizador.

 - pulsa para ajustar la hora.

Después de unos 5 segundos, el parpadeo cesa y la pantalla indica la hora ajustada.

Cómo cambiar: Hora

Paso 1  - pulsa repetidamente para cambiar la hora del día.  - empieza a parpadear.

Paso 2  - pulsa para ajustar la hora.

Después de unos 5 segundos, el parpadeo cesa y la pantalla indica la hora ajustada.

Cómo ajustar: Duración

Paso 1 Programa una función y una temperatura del horno.

Paso 2  - pulsa repetidamente.  - empieza a parpadear.

Paso 3  - pulsa para fijar la duración.

La pantalla muestra: .

 - parpadea cuando termina la hora ajustada. La señal suena y el horno se apaga.

Paso 4 Pulsa cualquier tecla para detener la señal.

Paso 5 Gira los mandos a la posición de apagado.

Cómo ajustar: Avisador

Paso 1  - pulsa repetidamente.  - empieza a parpadear.

Paso 2  - pulsa para ajustar la hora.

La función empieza automáticamente tras 5 segundos.

Al finalizar el tiempo programado, sonará la señal acústica.

Paso 3 Pulsa cualquier tecla para detener la señal.

Paso 4 Gira los mandos a la posición de apagado.

Instrucciones para cancelar: Funciones del reloj

Paso 1  - pulsa repetidamente hasta que el símbolo de la función de reloj empiece a parpadear.

Paso 2 Mantén pulsado: .

La función de reloj se apaga después de unos segundos.

9. USO DE LOS ACCESORIOS



ADVERTENCIA!

Consulte los capítulos sobre seguridad.

9.1 Inserción de accesorios

Una pequeña muesca en la parte superior aumenta la seguridad. Las hendiduras

también son dispositivos anti-vuelco. El borde elevado que rodea la bandeja evita que los utensilios de cocina resbalen de la parrilla.

Parrilla:

Inserte la parrilla entre las guías del carril y asegúrese de que las hendiduras apuntan hacia abajo.

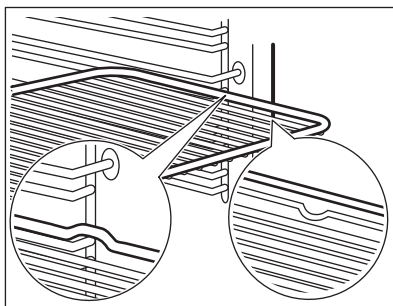

Bandeja:

Introduzca la bandeja entre las guías del carril de apoyo.

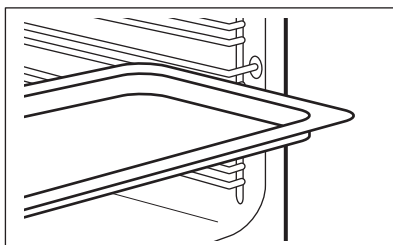

Parrilla, Bandeja:

Posicione la bandeja entre las guías del carril de apoyo y la parrilla en las guías de encima.

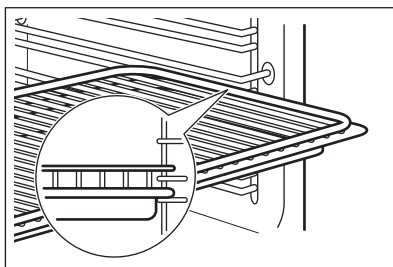

10. FUNCIONES ADICIONALES

10.1 Ventilador de enfriamiento

Cuando el horno funciona, el ventilador de enfriamiento se pone en marcha automáticamente para mantener frías las superficies del horno. Una vez apagado el horno, el ventilador sigue funcionando hasta enfriarlo totalmente.

10.2 Termostato de seguridad

El funcionamiento incorrecto del horno o los componentes defectuosos pueden provocar

sobrecalentamientos peligrosos. Para evitarlo, el horno dispone de un termostato de seguridad que interrumpe la alimentación. El horno se vuelve a encender automáticamente cuando desciende la temperatura.

11. CONSEJOS



Consulte los capítulos sobre seguridad.

11.1 Recomendaciones de cocción

El horno tiene cuatro niveles.

Cuente los niveles de las parrillas desde abajo hacia arriba.

El comportamiento de su horno puede ser diferente al del que tenía anteriormente. Las tablas siguientes le proporcionan los ajustes estándares de temperatura, tiempo de cocción y posición de la parrilla.

Si no encuentra los ajustes para una receta especial, busque otra similar.

El horno está dotado con un sistema especial que hace circular el aire y recicla constantemente el vapor. Gracias a este sistema puede cocinar con un entorno de vapor y mantener los alimentos blandos en su interior y crujientes en su exterior. Reduce el tiempo de cocción y el consumo de energía.

Repostería

No abra la puerta del horno antes de que transcurran 3/4 partes del tiempo de cocción establecido.

Si utiliza dos bandejas al mismo tiempo, deje un nivel libre entre ambas.

Carnes y pescados

Antes de trincar la carne, déjela reposar unos 15 minutos, como mínimo, para que retenga los jugos.





Para evitar que se forme mucho humo en el horno, vierta un poco de agua en la bandeja honda. Para evitar la condensación de humos, añada agua después de cada vez que se seque.

Tiempos de cocción





Los tiempos de cocción dependen del tipo de alimento, de su consistencia y del volumen.







Inicialmente, supervise el rendimiento cuando cocine. Busque los ajustes óptimos (de calor, tiempo de cocción, etc.) para sus recipientes, recetas y cantidades cuando utilice este horno.

11.2 Horneado y asado







RE- POSTERÍA	Cocción convencio- nal		Aire caliente		(min)	
	 (°C)		 (°C)			
Masas batidas	170	2	160	2 (1 y 3)	45 - 60	Molde de pastel
Masa con mantequi- lla	170	2	160	2 (1 y 3)	24 - 34	Molde de pastel
Tarta de queso (con suero)	170	1	160	2	60 - 80	Molde de pastel, Ø 26 cm
Strudel	175	2	150	2	60 - 80	Bandeja
Tarta de mermelada	170	2	160	2	30 - 40	Molde de pastel, Ø 26 cm
Pastel de fruta	170	2	155	2	60 - 70	Molde de pastel, Ø 26 cm
Tronco de Navidad / Pastel de fruta	170	2	160	2	50 - 60	Molde de pastel, Ø 20 cm
Pastel de ciruelas, precaliente el horno vacío	170	2	160	2	50 - 60	Molde para pan
Galletas, precaliente el horno vacío	150	3	150	3	20 - 30	Bandeja
Merengues	100	3	100	3	90 - 120	Bandeja
Bollos, precaliente el horno vacío	190	3	180	3	15 - 20	Bandeja
Hojaldre para relle- nar, precaliente el horno vacío	190	3	180	3	25 - 35	Bandeja
Tartaletas	180	3	170	2	45 - 70	Molde de pastel, Ø 20 cm
Tarta Victoria	180	1 o 2	170	2	40 - 55	Molde de pastel, Ø 20 cm

Precaliente el horno vacío.

PAN Y PIZZA	Cocción convencio- nal		Aire caliente		(min)	
	 (°C)		 (°C)			
Pan blanco, 1 - 2 trozos, 0,5 kg cada	190	1	190	1	60 - 70	-





 PAN Y PIZZA	Cocción convencional		Aire caliente		 (min)	
	 (°C)		 (°C)			
Pan de centeno, no se necesita precalentar	190	1	180	1	30 - 45	Molde para pan
Pan/Rollitos, 6 - 8 panecillos	190	2	180	2 (1 y 3)	25 - 40	Bandeja
Pizza	190	1	190	1	20 - 30	Bandeja honda
Bollitos	200	3	190	2	10 - 20	Bandeja







Use el molde de repostería.







 FLANES	Cocción convencional		Aire caliente		 (min)
	 (°C)		 (°C)		
Pudin de pasta	180	2	180	2	40 - 50
Pudin de verduras	200	2	175	2	45 - 60
Quiches	190	1	190	1	40 - 50
Lasaña	200	2	200	2	25 - 40
Canelones	200	2	190	2	25 - 40
Pudin Yorkshire, 6 moldes de pudin precaliente el horno vacío	220	2	210	2	20 - 30

Use el segundo nivel.

Utilice la parrilla.

 CARNE	Cocción convencional		Aire caliente		
	 (°C)		 (°C)		
Carne de res	200		190		50 - 70
Cerdo	180		180		90 - 120
Ternera	190		175		90 - 120
Rosbif poco hecho	210		200		44 - 50
Rosbif en su punto	210		200		51 - 55
Rosbif muy hecho	210		200		55 - 60

 CARNE	Cocción convencional		Aire caliente		 (min)
	 (°C)		 (°C)		
Paletilla de cerdo, con corteza	180	2	170	2	120 - 150
Morcillo de cerdo, 2 trozos	180	2	160	2	100 - 120
Pata de cordero	190	2	190	2	110 - 130
Pollo entero	200	2	200	2	70 - 85
Pavo entero	180	1	160	1	210 - 240
Pato entero	175	2	160	2	120 - 150
Ganso entero	175	1	160	1	150 - 200
Conejo, en trozos	190	2	175	2	60 - 80
Liebre, en trozos	190	2	175	2	150 - 200
Faisán entero	190	2	175	2	90 - 120





 PESCADO	Cocción convencional		Aire caliente		 (min)
	 (°C)		 (°C)		
Trucha / Pargo, 3 - 4 pescados	190	2	175	2 (1 y 3)	40 - 55
Atún / Salmón, 4 - 6 filetes	190	2	175	2 (1 y 3)	35 - 60





11.3 Grill

Precaliente el horno vacío.

Use el tercer nivel.

Ajuste la temperatura a 250 °C.

 GRILL	 (kg)	 (min)	 (min)
		1ª cara	2ª cara
Filetes de solomillo, 4 piezas	0,8	12 - 15	12 - 14
Bistec de vaca, 4 piezas	0,6	10 - 12	6 - 8
Salchichas, 8	-	12 - 15	10 - 12
Chuletas de cerdo, 4 piezas	0,6	12 - 16	12 - 14
Pollo, medio, 2	1	30 - 35	25 - 30
Brochetas, 4	-	10 - 15	10 - 12



 GRILL	 (kg)	 (min) 1ª cara	 (min) 2ª cara
Pechuga de pollo, 4 piezas	0,4	12 - 15	12 - 14
Hamburguesas, 6	0,6	20 - 30	-
Filete de pescado, 4 piezas	0,4	12 - 14	10 - 12
Sándwiches tostados, 4 - 6	-	5 - 7	-
Tostadas, 4 - 6	-	2 - 4	2 - 3

11.4 Grill Turbo





Precalente el horno vacío.





Ajuste la temperatura a 200 °C.

Use el tercer nivel.

	 (kg)	 (min)	
		1ª cara	2ª cara
Redondo, pavo	1	30 - 40	20 - 30
Pollo, medio, 2	1	25 - 30	20 - 30
Muslos de pollo, 6 piezas	-	15 - 20	15 - 18
Codorniz, 4 piezas	0,5	25 - 30	20 - 25
Verduras al gratén	-	20 - 25	-
Vieiras	-	15 - 20	-
Caballa, 2 - 4	-	15 - 20	10 - 15
Pescado en rodajas, 4 - 6	0,8	12 - 15	8 - 10

11.5 Descongelar

	 (kg)	 Tiempo de descongelación (min)	 Tiempo de descongelación posterior (minutos)	
Pollo	1	100 - 140	20 - 30	Coloque el pollo sobre un plato puesto del revés sobre otro mayor. Dele la vuelta a media cocción.

	 (kg)	 Tiempo de descongelación (min)	 Tiempo de descongelación posterior (minutos)	
Carne	1 0.5	100 - 140 90 - 120	20 - 30	Dele la vuelta a media cocción.
Nata	2 x 0,2	80 - 100	10 - 15	La nata se puede montar perfectamente incluso aunque queden puntos ligeramente congelados.
Trucha	0.15	25 - 35	10 - 15	-
Fresas	0.3	30 - 40	10 - 20	-
Mantequilla	0.25	30 - 40	10 - 15	-
Pasteles	1.4	60	60	-

11.6 Horneado húmedo + ventil.. accesorios recomendados

Utilice molde y recipientes oscuros y mates. Tiene mejor absorción del calor que los platos de color claro y brillantes.



Bandeja para pizza

Oscuro, mate
28 cm de diámetro

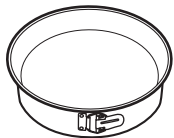

Bandeja para hornear

Oscuro, mate
26 cm de diámetro



Ramequines

Cerámica
8 cm de diámetro,
5 cm de altura

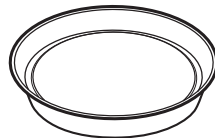











Molde para base

Oscuro, mate
28 cm de diámetro

11.7 Horneado húmedo + ventil.





Para obtener el mejor resultado, siga las recomendaciones de la tabla siguiente.

		 (°C)		 (min)
Rollitos dulces, 12 piezas	bandeja o bandeja honda	180	2	35 - 40
Rollitos, 9 piezas	bandeja o bandeja honda	180	2	35 - 40
Pizza congelada, 0,35 kg	parrilla	220	2	35 - 40
Brazo de gitano	bandeja o bandeja honda	170	2	30 - 40

		 (°C)		 (min)
Brownie	bandeja o bandeja honda	180	2	30 - 40
Soufflé, 6 piezas	ramekin cerámico sobre parrilla	200	3	30 - 40
Base de masa brisé	molde de base sobre parrilla	170	2	20 - 30
Tarta Victoria	bandeja de hornear sobre parrilla	170	2	35 - 45
Pescado pochado, 0,3 kg	bandeja o bandeja honda	180	3	35 - 45
Pescado entero, 0,2 kg	bandeja o bandeja honda	180	3	35 - 45
Filete de pescado, 0,3 kg	molde para pizza sobre parrilla	180	3	35 - 45
Carne pochada, 0,25 kg	bandeja o bandeja honda	200	3	40 - 50
Shashlik, 0,5 kg	bandeja o bandeja honda	200	3	25 - 35
Galletas, 16 piezas	bandeja o bandeja honda	180	2	20 - 30
Mostachones de almendra, 20 piezas	bandeja o bandeja honda	180	2	40 - 45
Muffins, 12 piezas	bandeja o bandeja honda	170	2	30 - 40
Tarta salada, 16 piezas	bandeja o bandeja honda	170	2	35 - 45
Galletas crujientes de masa quebrada, 20 piezas	bandeja o bandeja honda	150	2	40 - 50
Tartaletas, 8 piezas	bandeja o bandeja honda	170	2	20 - 30
Verduras pochadas, 0,4 kg	bandeja o bandeja honda	180	3	35 - 40
Tortilla vegetariana	molde para pizza sobre parrilla	200	3	30 - 45
Verduras mediterráneas, 0,7 kg	bandeja o bandeja honda	180	4	35 - 40

11.8 Información para los institutos de pruebas

Pruebas conforme a IEC 60350-1.

				(°C)	(min)	
Pastillos, 20 unidades por bandeja	Cocción convencional	Bandeja de cocción	3	170	20 - 30	-
Tarta de manzana, 2 moldes, Ø 20 cm	Cocción convencional	Parrilla	1	170	80 - 120	-
Bizcocho, molde de repostería Ø26 cm	Cocción convencional	Parrilla	2	170	35 - 45	-
Mantecados	Cocción convencional	Bandeja de cocción	3	150	20 - 35	Precaliente el horno 10 minutos.
Tostadas, 4 - 6 trozos	Grill	Parrilla	3	máx.	2 - 4 minutos el primer lado; 2 - 3 minutos el segundo	Precaliente el horno 3 minutos.
Hamburguesa de vacuno, 6 trozos, 0,6 kg	Grill	Parrilla y graseras	3	máx.	20 - 30	Coloque la parrilla en el tercer nivel y la graseras en el segundo nivel del horno. Dele la vuelta a la mitad del tiempo. Precaliente el horno 3 minutos.

12. MANTENIMIENTO Y LIMPIEZA



ADVERTENCIA!

Consulte los capítulos sobre seguridad.

12.1 Notas sobre la limpieza



Agentes limpiadores

Limpie la parte delantera del horno con un paño suave humedecido en agua templada y jabón suave. Limpie y compruebe la junta de la puerta alrededor del interior.

Utilice un producto de limpieza para limpiar las superficies metálicas.

Limpie las manchas con un detergente suave.



Uso diario

Limpie el interior después de cada uso. La acumulación de grasa u otros residuos puede provocar un incendio.

La humedad puede llegar a condensarse en el horno o en los paneles de cristal. Para reducir la condensación, ponga en funcionamiento el horno 10 minutos antes de cocinar. No guarde la comida en el horno más de 20 minutos. Seque el interior con un paño suave después de cada uso.



Limpie todos los accesorios después de cada uso y déjelos secar. Use un paño suave humedecido en agua caliente y detergente suave. No lave los accesorios en el lavavajillas

No limpie los accesorios no adherentes utilizando un limpiador abrasivo ni objetos afilados.

Accesorios

12.2 Cómo quitar: Apoyos de baldas

Para limpiar el horno, retire los carriles de apoyo.

Paso 1 Apague el horno y espere a que esté frío.

Paso 2 Tire de la parte delantera del carril de apoyo para separarlo de la pared lateral.

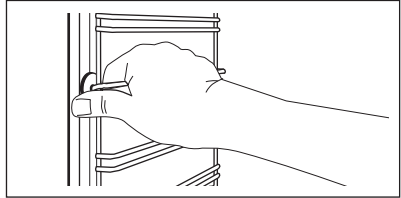

Paso 3 Tire del extremo trasero del carril de apoyo para despegarlo de la pared lateral y sáquelo.

Paso 4 Coloque los carriles de apoyo en el orden inverso.

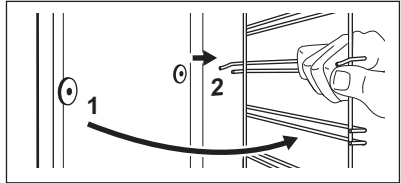

12.3 Cómo quitar e instalar: Puerta

La puerta del horno tiene dos paneles de cristal. Es posible retirar la puerta del horno y el panel de cristal interior para limpiarlos. Lea las instrucciones completas de "Extracción e instalación de la puerta" antes de retirar los paneles de cristal.



PRECAUCIÓN!

No utilice el aparato sin los paneles de cristal.

Paso 1 Abra completamente la puerta y sujete las dos bisagras.

Paso 2

Levante y gire completamente las palancas de ambas bisagras.

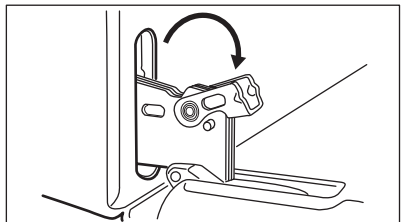
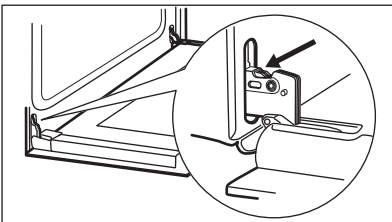

Paso 3 Cierre la puerta del horno a medio camino hasta la primera posición de apertura. A continuación levante la puerta y tire hacia adelante para descajarla.

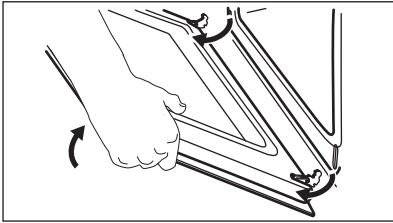

Paso 4 Ponga la puerta en un paño suave sobre una superficie estable y libere el sistema de bloqueo para quitar el panel de vidrio interno.

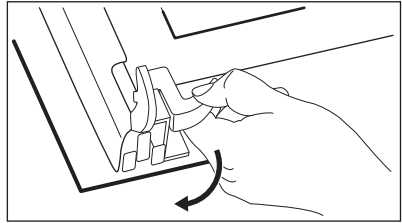

Paso 5 Gire los pasadores en un ángulo de 90° y extráigalos de sus asientos.

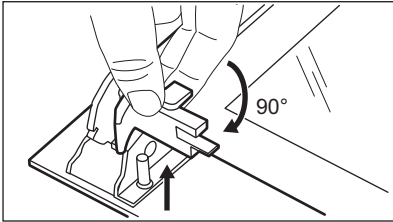

Paso 6 Levante con cuidado primero y retire después el panel de cristal.

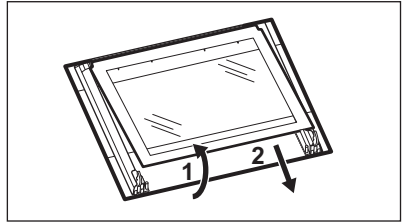

Paso 7 Limpie los paneles de cristal con agua y jabón. Seque los paneles de cristal con cuidado. No limpie los paneles de cristal en el lavavajillas.

Paso 8 Después de la limpieza, instale el panel de vidrio y la puerta del horno.

Al instalarlo correctamente, el acabado de la puerta hace clic.
Asegúrese de que coloca el panel de cristal interno en los soportes correctos.

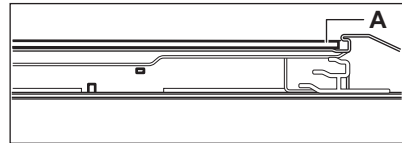

12.4 Cómo cambiar: Bombilla



ADVERTENCIA!

Riesgo de descarga eléctrica.
La lámpara puede estar caliente.

Antes de reemplazar la bombilla:

Paso 1

Apague el horno. Espere hasta que el horno esté frío.

Paso 2

Desconecte el horno de la red.

Paso 3

Coloque un paño en el fondo de la cavidad.

Bombilla trasera

- Paso 1** Gire la tapa de cristal para extraerla.
- Paso 2** Limpie la tapa de cristal.
- Paso 3** Cambie la bombilla por otra apropiada termorresistente hasta 300 °C.
- Paso 4** Coloque la tapa de cristal.

13. SOLUCIÓN DE PROBLEMAS



ADVERTENCIA!
Consulte los capítulos sobre seguridad.

13.1 Qué hacer si...

En cualquier caso no incluido en esta tabla, por favor contacte con un Centro de Servicio Autorizado.

Problema	Compruebe que...
El horno no calienta.	Ha saltado el fusible.
La junta de la puerta está dañada.	No utilice el horno. Póngase en contacto con un servicio técnico autorizado.
La pantalla muestra "12.00".	Ha habido un corte de alimentación. Ajusta el reloj.

Problema	Compruebe que...
La bombilla no funciona.	La bombilla se ha fundido.

13.2 Datos de servicio

Si no logra subsanar el problema, póngase en contacto con su distribuidor o el centro de servicio técnico.

Los datos que necesita para el centro de servicio técnico se encuentran en la placa de características. La placa de régimen se encuentra en el marco delantero de la cavidad del horno. No retire la placa de características de la cavidad del horno.

Es conveniente que anote los datos aquí:

Modelo (MOD.)

Número de producto (PNC)

Número de serie (S.N.)

14. EFICACIA ENERGÉTICA

14.1 Información del producto y Hoja de información del producto*

Nombre del proveedor	Zanussi
Identificación del modelo	ZOHEE2X1 944068087 ZOHIE2X1 944068089
Índice de eficiencia energética	94.9

Clase de eficiencia energética	A	
Consumo de energía con carga estándar, modo convencional	0.83 kWh/ciclo	
Consumo de energía con carga estándar, modo con ventilador	0.75 kWh/ciclo	
Número de cavidades	1	
Fuente de calor	Electricidad	
Volumen	57 l	
Tipo de horno	Horno empotrado	
Masa	ZOHEE2X1	28.6 kg
	ZOHIE2X1	28.6 kg

* Para la Unión Europea según los Reglamentos de la UE 65/2014 y 66/2014.
 Para la República de Bielorrusia según STB 2478-2017, apéndice G; STB 2477-2017, anexos A y B.
 Para Ucrania según 568/32020.

La clase de eficiencia energética no es aplicable a Rusia.

EN 60350-1 - Aparatos electrodomésticos - Parte 1: Placas, hornos, hornos de vapor y parrillas - Métodos para medir el rendimiento.

14.2 Ahorro de energía



El horno tiene características que le ayudan a ahorrar energía durante la cocina de cada día.

Asegúrese de que la puerta del horno está cerrada cuando el horno funciona. No abra la puerta del horno muchas veces durante la cocción. Mantenga limpia la junta de la puerta y asegúrese de que está bien fijada en su posición.

Utilice utensilios de cocina de metal para mejorar el ahorro energético.

En la medida de lo posible, no precaliente el horno antes de cocinar.

Reduzca al máximo el tiempo entre horneados cuando prepare varios platos de una vez.

Cocción con ventilador

En la medida de lo posible, utilice las funciones de cocción con ventilador para ahorrar energía.

Calor residual

Para una duración de la cocción superior a 30 minutos, reduzca la temperatura del horno un mínimo de 3 - 10 minutos antes de que transcurra el tiempo de cocción. El calor residual dentro del horno seguirá cocinando.

Utilice el calor residual para calentar otros platos.

Mantener calor

Si desea utilizar el calor residual para mantener calientes los alimentos, seleccione el ajuste de temperatura más bajo posible.

Horneado húmedo + ventil.

Función diseñada para ahorrar energía durante la cocción.

15. ASPECTOS MEDIOAMBIENTALES

Recicle los materiales con el símbolo .
 Coloque el material de embalaje en los

contenedores adecuados para su reciclaje. Ayude a proteger el medio ambiente y la salud pública, así como a reciclar residuos

de aparatos eléctricos y electrónicos. No deseche los aparatos marcados con el símbolo  junto con los residuos

domésticos. Lleve el producto a su centro de reciclaje local o póngase en contacto con su oficina municipal.

WWW.ZANUSSI.COM/SHOP



CE

867360243-A-402020