

▶ DA Brugsanvisning	2
NL Gebruiksaanwijzing	29
EN User Manual	58
FI Käyttöohje	85
FR Notice d'utilisation	112
DE Benutzerinformation	142
ES Manual de instrucciones	171
SV Bruksanvisning	200

USER MANUAL

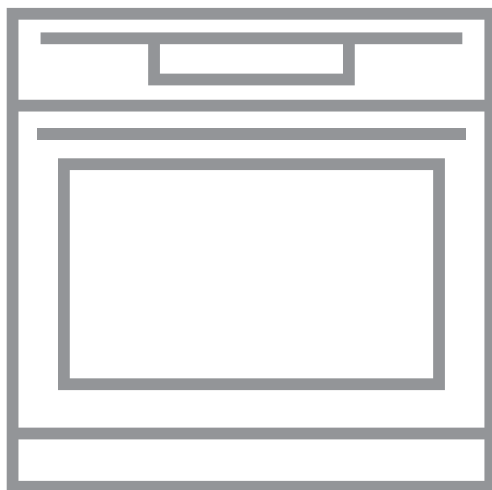

TIL PERFEKTE RESULTATER

Tak, fordi du valgte dette AEG-produkt. Vi har skabt det for at give dig upåklagelig ydeevne i mange år med innovative teknologier, som gør livet lettere – funktioner, som du måske ikke finder på almindelige apparater. Brug et par minutter på at læse mere – så du kan få det bedste ud af det.

Besøg vores hjemmeside for at:



få rådgivning, brochurer, fejlfinding, service- og reparationsinformation:
www.aeg.com/support



Registrér dit produkt for at få bedre service:
www.registeraeg.com



Køb tilbehør, forbrugsvarer og originale reservedele til dit apparat:
www.aeg.com/shop

KUNDEPLEJE OG SERVICE

Brug altid originale reservedele.

Sørg for at have følgende data klar, når du kontakter vores autoriserede servicecenter:

Model, PNC, serienummer.

Oplysningerne findes på typeskiltet.

 Advarsel/forsigtig-sikkerhedsanvisninger

 Generelle oplysninger og råd

 Miljøoplysninger

Ret til ændringer uden varsel forbeholdes.

INDHOLDSFORTEGNELSE

1. OM SIKKERHED.....	2
2. SIKKERHEDSANVISNINGER.....	4
3. PRODUKTBESKRIVELSE.....	7
4. BETJENINGSPANEL.....	7
5. FØR BRUG FØRSTE GANG.....	8
6. DAGLIG BRUG.....	8
7. BRUG AF TILBEHØRET.....	9
8. EKSTRAFUNKTIONER.....	10
9. RÅD OG TIPS.....	10
10. VEDLIGEHOLDELSE OG RENGØRING.....	24
11. FEJLFINDING.....	27
12. ENERGIEFFEKTIV.....	27

1. OM SIKKERHED

Læs brugsanvisningen grundigt, før apparatet installeres og tages i brug. Producenten påtager sig intet ansvar for

eventuelle skader, der er resultatet af forkert installation eller brug. Opbevar altid brugsanvisningen på et sikkert og tilgængeligt sted til senere opslag.

1.1 Sikkerhed for børn og sårbare personer

- Apparatet må kun bruges af børn fra 8 år og opefter samt af personer med nedsat fysisk, sensorisk eller psykisk funktionsevne, eller som mangler den nødvendige erfaring eller viden, hvis de er under opsyn eller er blevet instrueret i at bruge apparatet på en sikker måde samt forstår de farer, det indebærer. Børn under 8 år og personer med omfattende og komplekst handicap skal holdes på afstand af apparatet, medmindre de overvåges konstant.
- Børn skal holdes under opsyn for at sikre, at de ikke leger med apparatet.
- Opbevar al emballage utilgængeligt for børn, og bortskaf det korrekt.
- ADVARSEL: Lad ikke børn og husdyr komme tæt på apparatet, når det er i drift, eller mens det køler af. Tilgængelige dele bliver meget varme under brug.
- Hvis apparatet har en børnesikring, skal den aktiveres.
- Børn må ikke udføre rengøring og vedligeholdelse på produktet uden opsyn.

1.2 Generel sikkerhed

- Kun en faguddannet installatør må installere apparatet og udskifte kablet.
- Brug ikke apparatet, inden det monteres i den indbyggede struktur.
- Før enhver vedligeholdelse skal apparatet kobles fra elnettet.
- Hvis strømforsyningskablet er beskadiget, skal det af sikkerhedsmæssige grunde udskiftes af producenten, et autoriseret servicecenter eller en tekniker for at undgå elektrisk stød.

- Betjeningspanelet skal forbindes til den specificerede opvarmingsenhed med matchende stikfarver for at undgå risiko for farer.
- Kontakt til afbrydelse skal være indbygget i den faste ledningsføring i overensstemmelse med reglerne for ledningsføring.
- ADVARSEL: Se efter, at der er slukket for apparatet, inden pæren skiftes. Ellers er der risiko for elektrisk stød.
- ADVARSEL: Apparatet og de tilgængelige dele bliver meget varme under brug. Pas på ikke at røre varmelegemerne.
- Brug altid ovnhandsker til at tage ribber eller ovnfaste fade ud eller sætte dem i.
- For at fjerne ovnribberne skal du først trække ovnribbens forende og derefter dens bagende væk fra sidevæggene. Montér ovnribberne i omvendt rækkefølge.
- Undlad at bruge en damprenser til at rengøre apparatet.
- Brug ikke skrappe slibende rengøringsmidler eller skarpe metalskrabere til at rengøre ovnruden. De kan ridse overfladen, med det resultat, at glasset knuses.

2. SIKKERHEDSANVISNINGER

2.1 Installation



ADVARSEL!

Apparatet må kun installeres af en sagkyndig.

- Fjern al emballagen.
- Undlad at installere eller bruge et beskadiget apparat.
- Følg installationsvejledningen, der følger med apparatet.
- Vær altid forsigtig, når du flytter apparatet, da det er tungt. Brug altid sikkerhedshandsker og lukket fodtøj.
- Træk aldrig i apparatet i håndtaget.
- Installér apparatet et sikkert og velegnet sted, der opfylder installationskrav.
- Køkkenskabet og indhakkets skal have passende mål.
- Mindsteafstanden til andre apparater og enheder skal overholdes.

- Før montering af apparatet kontrolleres, om ovnlugen åbner uden modstand.
- Apparatets dele kan være strømførende. Luk apparatet sammen med køkkenelementet for at forhindre, at de farlige dele berøres.
- Apparatet er udstyret med et elektrisk afkølingssystem. Det skal betjenes med den elektriske strømforsyning.
- Indbygningsskabets stabilitet skal opfylde kravene i DIN 68930.

Kabinettets minimumshøjde (kabinets minimumshøjde under bordpladen)	578 (600) mm
---	--------------

Kabinet, bredde	560 mm
-----------------	--------

Kabinet, dybde	550 (550) mm
----------------	--------------

Højde foran på apparatet	594 mm
--------------------------	--------

Højde bagest på apparatet	576 mm
---------------------------	--------

Bredde foran på apparatet	595 mm
Bredde bagest på apparatet	559 mm
Apparatets dybde	567 mm
Apparatets indbygningsdybde	546 mm
Dybde med åben dør	1027 mm
Ventilationsåbning minimumsstørrelse. Åbning placeret på bundens bageste side	560 x 20 mm
Monteringskruser	4 x 25 mm

2.2 El-forbindelse



ADVARSEL!

Risiko for brand og elektrisk stød.

- Alle elektriske tilslutninger skal udføres af en kvalificeret elektriker.
- Apparatet skal tilsluttes strøm m/jord, jvf. Stærkstrømsreglementet.
- Sørg for, at parametrene på typeskiltet er kompatible med nettilslutningens elektriske mærkeværdier.
- Brug altid en korrekt monteret lovlig stikkontakt.
- Brug ikke multistikadaptere og forlængerledninger.
- Pas på, du ikke beskadiger netstikket og netledningen. Hvis der bliver behov for at udskifte netledningen, skal det udføres af vores autoriserede servicecenter.
- Elledninger må ikke komme i berøring med eller nær ved apparatets låge, især når det er tændt, eller lågen er varm.
- Beskyttelsen mod elektrisk stød fra strømførende og isolerede dele skal fastgøres, så den ikke kan fjernes uden værktøj.
- Sæt først netstikket i stikkontakten ved installationens afslutning. Sørg for, at der er adgang til elstikket efter installationen.
- Hvis stikkontakten er løs, må du ikke sætte netstikket i.
- Undgå at slukke for apparatet ved at trække i netledningen. Tag altid selve netstikket ud af kontakten.
- Brug kun korrekte isoleringsenheder: Gruppeafbrydere, sikringer (sikringer med

skruegevind skal tages ud af fatningen), fejlstrømsrelæer og kontaktorer.

- Apparatets installation skal udføres med et isolationsudstyr, så forbindelsen til lysnettet kan afbrydes på alle poler. Isolationsudstyret skal have en brydeafstand på mindst 3 mm.
- Dette apparat er forsynet med et stik og en strømledning.

2.3 Brug



ADVARSEL!

Risiko for personskade, forbrændinger og elektrisk stød eller eksplosion.

- Dette apparat er kun til husholdningsbrug (indendørs).
- Apparatets specifikationer må ikke ændres.
- Sørg for, at ventilationsåbningerne ikke er blokerede.
- Lad ikke apparatet være uden opsyn under drift.
- Sluk for apparatet efter hver brug.
- Vær forsigtig, når du åbner apparatets låge, hvis apparatet er i brug. Der kan slippe varm luft ud.
- Betjen ikke apparatet med våde hænder, eller når det har kontakt med vand.
- Tryk ikke på den åbne låge.
- Brug ikke apparatet som arbejds- eller fræsætningsplads.
- Åbn apparatets låge forsigtigt. Brug af ingredienser med alkohol kan forårsage en blanding af alkohol og luft.
- Lad ikke gnister eller åben ild komme i kontakt med apparatet, når du åbner lågen.
- Læg ikke brændbare produkter eller genstande, der er våde med brændbare produkter i nærheden af eller på apparatet.



ADVARSEL!

Risiko for beskadigelse af apparatet.

- Sådant undgås skader eller misfarvning af emaljen:
 - Stil ikke ovnfaste fade eller andre genstande direkte i apparatet.
 - Læg ikke aluminiumsfolie direkte på bunden af ovnrummet.

- Hæld ikke vand direkte ind i det varme apparat.
- Hold ikke fugtige fade og madvarer i apparatet, når du har afsluttet tilberedningen.
- Vær forsigtig, når du fjerner eller monterer tilbehøret.
- Farveændring af emaljen eller rustfrit stål forringer ikke apparatets ydeevne.
- Brug en bradepande til fugtige kager. Frugtsaft forårsager pletter, der kan være permanente.
- Dette apparat må kun anvendes til tilberedning af fødevarer. Det må ikke bruges til andre formål, f.eks. rumopvarmning.
- Hold altid ovnlågen lukket under tilberedningen.

2.4 Vedligeholdelse og rengøring



ADVARSEL!

Risiko for personskade, brand eller skade på apparatet.

- Sluk for apparatet, og tag stikket ud af kontakten inden vedligeholdelse.
- Kontrollér, at apparatet er kølet af. Der er risiko for, at ovnglasset går i stykker.
- Udskift øjeblikkeligt ovnglassets paneler, hvis de er beskadigede. Kontakt det autoriserede servicecenter.
- Vær forsigtig, når du tager lågen af apparatet. Døren er tung!
- Rengør jævnligt apparatet for at forhindre forringelse af overfladematerialet.
- Rengør apparatet med en fugtig, blød klud. Brug kun neutrale rengøringsmidler. Brug ikke slibende midler, skuresvampe, opløsningsmidler eller metalgenstande.
- Hvis du bruger en ovnspray, skal du følge instruktionerne på dens emballage.

2.5 Indvendig belysning



ADVARSEL!

Risiko for elektrisk stød.

- Vedrørende lampe(r) i dette produkt og reservedelslamper, der sælges separat: Disse lamper er beregnet til at modstå ekstreme fysiske forhold i husholdningsapparater, såsom temperatur, vibration, fugt, eller er beregnet til at signalere information om apparatets driftsstatus. De er ikke beregnet til at blive brugt i andre apparater, og de er ikke velegnede til belysning af rum.
- Brug kun lamper med de samme specifikationer.

2.6 Service

- Kontakt det autoriserede servicecenter for at få repareret apparatet.
- Brug kun originale reservedele.

2.7 Bortskaffelse



ADVARSEL!

Risiko for personskade eller kvælning.

- Kontakt din genbrugsplads ang. oplysninger om, hvordan produktet bortskaffes korrekt.
- Tag stikket ud af kontakten.
- Klip netledningen af tæt ved apparatet og bortskaf den.
- Fjern lågelåsen for at forhindre, at børn eller kæledyr bliver fanget i apparatet.

3. PRODUKTBESKRIVELSE

3.1 Oversigt over apparatet

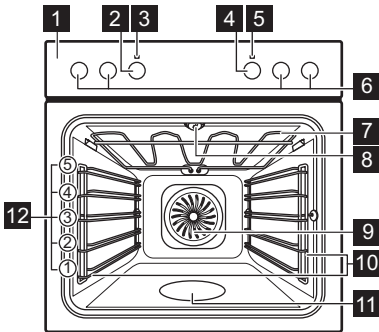

- 1 Betjeningspanel
- 2 Knap til ovnfunktioner
- 3 Strømindikator/-symbol
- 4 Betjeningsknap (til temperatur)
- 5 Temperaturindikator/-symbol
- 6 Knapper til kogezone
- 7 Varmelegeme
- 8 Ovnør
- 9 Blæser
- 10 Ovnribbe, udtagelig
- 11 Ovnrumspregning
- 12 Ovnriiler

3.2 Tilbehør

Grillrist

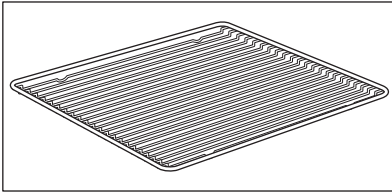

Til kogevej, kageforme, stege.

Bradepande

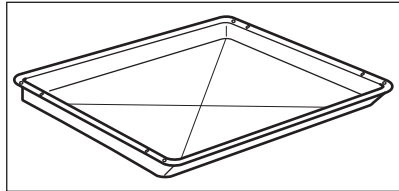

Til kager og småkager. Til at bage og stege eller som en pande til opsamling af fedt.

4. BETJENINGSPANEL

4.1 Knapper til kogezone

Du kan bruge kogesektionen med knapperne til kogezoneerne.



Du skal læse kapitlet Om sikkerhed i kogesektionens brugsanvisning.

4.2 Varmeindstillinger

Knapangivelse	Funktion
0	Slukposition
	Trin til holde varm

Knapangivelse	Funktion
1 - 9	Varmeindstillinger

1. Drej knappen til en nødvendig varmeindstilling.

2. Drej knappen til slut-positionen for at afslutte tilberedningsprocessen.

4.3 Opkogningsautomatik



Er kun relevant for kogesektioner med opkogningsautomatik.

Opkogningsautomatikken opvarmer kogezone på fuld effekt i et stykke tid.

1. Drej knappen til kogezone med uret, så langt den kan komme (forbi det højeste varmetrin).
2. Indstil straks det ønskede varmetrin.

3. Drej knappen til positionen SLUK for at afbryde funktionen.

4.4 Brug af dobbelt-zonen (hvis relevant)



Drej knappen med uret for at aktivere dobbeltzonen. Drej den ikke gennem stop-positionen.

1. Drej knappen med uret til positionen 9.
2. Drej knappen langsomt, indtil du hører et klik. De to kogezone er tændt.
3. Se under "Varmetrin" for at indstille det nødvendige varmetrin.

5. FØR BRUG FØRSTE GANG



ADVARSEL!

Se kapitlerne om sikkerhed.

5.1 Før brug første gang

Ovnen kan udsende lugt og røg under forvarmning. Kontroller, at rummet er udluftet.



Trin 1





Trin 2

Rengør ovnen

1. Fjern al tilbehøret fra ovnen og tag de udtagelige ovnrubber ud af ovnen.
2. Rengør ovnen og tilbehøret med en blød klud, varmt vand og et mildt rengøringsmiddel.

Forvarm den tomme ovn

1. Indstil den maksimale temperatur for funktionen:

Tid: 1 t.
2. Indstil den maksimale temperatur for funktionen:

Tid 15 min.

Sluk for ovnen, og vent, til den er kold. Placér tilbehøret og de aftagelige ribber i ovnen.

6. DAGLIG BRUG



ADVARSEL!

Se kapitlerne om sikkerhed.









6.1 Indstilling: Ovnfunktion

Trin 1 Drej ovenns funktionsvælger for at vælge en ovnfunktion .

Trin 2 Drej funktionsvælgeren for at vælge temperaturen.

Trin 3 Når tilberedningen ender, skal du dreje knapperne til slukket position for at slukke for ovnen.

6.2 Ovnfunktioner

Ovnfunktion	Applikation
 Slukposition	Ovnen er slukket.
 Lys	Til at tænde lampen.
 Varmluft	Bagning på op til tre ovnriller samtidig og til tørring af fødevarer. Indstil temperaturen 20 - 40 °C lavere end ved Over-/undervarme.
 Pizza-funktionen	Til at bage pizza. Til at lave en kraftig bruning og en sprød bund.
 Over-/undervarme	Til bagning og stegning af mad på én ovnrille.
 Undervarme	Til bagning af kager med sprød bund og til henkogning.
 Optøning	Til optøning af mad (grøntsager og frugt). Optøningstiden afhænger af mængde og omfang af de de frosne madvarer.
 Fugtig varmluft	Denne funktion er beregnet til at spare energi under madlavning. Når du bruger denne funktion, kan temperaturen i ovnrummet variere fra den indstillede temperatur. Varmeeffekten kan blive reduceret. Få flere oplysninger i kapitlet "Daglig brug", Bemærkninger til: Fugtig varmluft.

Ovnfunktion	Applikation
 Grill	Til grillstegning af tynde stykker mad og til ristning af brød.
 Turbo grill	Til stegning af større stykker kød eller fjerkræ med ben på én hyldeposition. For at lave gratiner og til at brune.

 Lampen kan blive slukket automatisk ved en temperatur på under 60 °C under visse ovnfunktioner.

6.3 Bemærkninger til: Fugtig varmluft

Denne funktion blev anvendt til at overholde kravene i energieffektivitetsklasse og økodesign i overensstemmelse med EU 65/2014 og EU 66/2014. Test i henhold til EN 60350-1.

Ovnlågen skal være lukket under tilberedningen, så funktionen ikke afbrydes, og ovnen kører med den højeste energieffektivitet, der er mulig.

Se kapitlet "Råd" for at få oplysninger om tilberedningsvejledningen. Fugtig varmluft. Se kapitlet "Energieffektivitet", Energibesparelse for generelle anbefalinger til energibesparelse.

7. BRUG AF TILBEHØRET



ADVARSEL!

Se kapitlerne om sikkerhed.

7.1 Isætning af tilbehør

En lille fordybning i toppen øger sikkerheden. Fordybningerne er også antivippe-

anordninger. Den høje kant omkring hylden forhindrer kogegrej i at glide af hylden.

Trådrist:

Skub risten mellem ovnribbens skinner, .

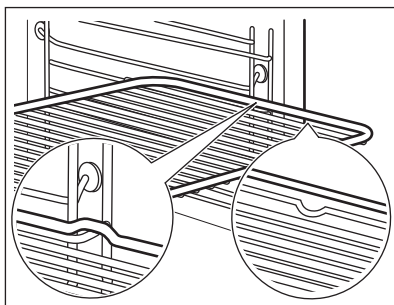
**Dyb bradepande:**

Skub pladen ind mellem skinnerne ud for den valgte rille.

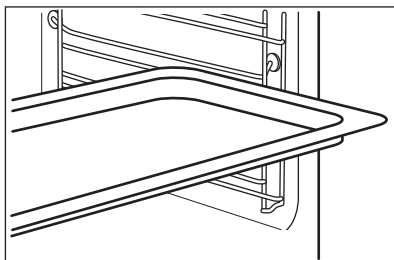
**Trådrist, Dyb bradepande:**

Skub pladen ind mellem ovnribbernes skinner og grillristen på skinnerne ovenover.

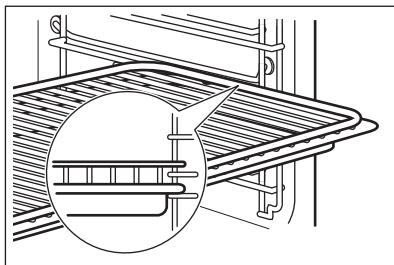

8. EKSTRAFUNKTIONER

8.1 Køleventilator

Når ovnen er i brug, tændes blæseren automatisk for at holde ovnen kølig på de

udvendige sider. Hvis du slukker for ovnen, kan køleblæseren fortsat være i brug, indtil ovnen afkøles.

9. RÅD OG TIPS



Se kapitlerne om sikkerhed.

9.1 Eksempler på tilberedningsanvendelser for kogesektionen

Varmeindstilling	Egnet til	Tid (min.)	Råd
1	Til at holde tilberedt mad varm.	efter behov	Læg et låg på kogegrejet.
1 - 2	Til hollandaisesovs og til smeltning af smør, chokolade og husblas.	5 - 25	Rør med mellemrum.
1 - 2	Til størknede, luftige omeletter og bagte æg.	10 - 40	Læg låg på under tilberedningen.
2 - 3	Til småkogning af ris og mælkeretter samt til opvarmning af færdigretter.	25 - 50	Tilsæt mindst dobbelt så meget væske som ris. Rør i mælkeretter, når halvdelen af tiden er gået.
3 - 4	Til dampning af grøntsager, fisk og kød.	20 - 45	Tilføj nogle spsk. af væske.
4 - 5	Til dampning af kartofler.	20 - 60	Brug højst 1/4 l vand til 750 g kartofler.
4 - 5	Til kogning af større portioner, sammenkogte retter og supper.	60 - 150	Tilføj højst 3 l væske til ingredienserne.
6 - 7	Til let stegning af schnitzel, cordon bleu (kalvekød), koteletter, frikadeller, pølser, lever, æg, pandekager, æbleskiver samt opbagt sauce.	efter behov	Vendes undervejs.
7 - 8	Til røsti, tournedos, steaks.	5 - 15	Vendes undervejs.
9	Til kogning af større mængder vand, pasta, brunng af kød (gullasch, grydesteg) og til friturekogning af pommel frites.		

9.2 Anbefalinger til tilberedning



Tabellernes temperaturer og tilberedningstider er kun vejledende. De afhænger af opskifterne samt af kvaliteten og mængden af de anvendte ingredienser.

Din ovn kan have andre bage-/stegeegenskaber end den ovn, du havde før. Tabellerne herunder viser anbefalede indstillinger for temperatur, tilberedningstid og hyldeposition for specifikke typer mad.

Hvis du ikke kan finde indstillinger til en speciel opskrift, kan du se efter en lignende.

9.3 Bagning

Brug den lavere temperatur ved første bagning.

Bagetiden kan forlænges med 10 – 15 minutter, når du bager på mere end én ribbe.

Kager og bagværk med forskellig højde kan brune ujævnt. Der er ikke nødvendigt at





ændre temperaturindstillingen, hvis der sker en ujævn brunng. Forskellene udlignes under bagning.

Plader i ovnen kan blive forvredet under bagning. Pladerne retter sig ud, når de er kølet af.

9.4 Bagetip

Bageresultater	Mulige årsager	Løsning
Kagens bund er ikke bagt nok.	Forkert ovnrille.	Sæt kagen i en lavere ovnrille.
Kagen falder sammen og bliver klæg eller med vandstriber.	Der er for høj ovntemperatur.	Vælg en lidt lavere ovntemperatur den næste gang.
	Ovntemperaturen er for høj, og bagetiden er for kort.	Vælg en længere bagetid og en lavere ovntemperatur den næste gang.
Kagen er for tør.	Der er for lav ovntemperatur.	Vælg en højere ovntemperatur den næste gang.
	Bagetiden er for lang.	Vælg en kortere bagetid den næste gang.
Kagen bliver ujævn bagt.	Ovntemperaturen er for høj, og bagetiden er for kort.	Vælg en længere bagetid og en lavere ovntemperatur den næste gang.
	Kagedejen er ikke jævnt fordelt.	Fordel kagedejen jævnt på bagepladen den næste gang.
Kagen er ikke klar på bagetiden angivet i en opskrift.	Der er for lav ovntemperatur.	Vælg en lidt højere ovntemperatur den næste gang.



9.5 Bagning på én ribbe

 BAG- VÆRK I FORM		 (°C)	 (min.)	
Tærtebund - mørdej, forvarm den tomme ovn	Varmluft	170 - 180	10 - 25	2
Tærtebund - rørt kagedej	Varmluft	150 - 170	20 - 25	2
Gærkage / Croissant	Varmluft	150 - 160	50 - 70	1
Sandkage / Frugtkager	Varmluft	140 - 160	70 - 90	1
Kvarkkage	Over-/undervarme	170 - 190	60 - 90	1

Brug ovnens tredje ristposition.

Brug funktionen: Varmluft.

Brug en bradepande.

 KAGER/BAGVÆRK/BRØD	 (°C)	 (min.)
Kage med chokoladeflager, tør	150 - 160	20 - 40

**KAGER/BAGVÆRK/BRØD****(°C)****(min.)**

Frugttærter (på gærdej/rørt kagedej), brug en bradepande

150

35 - 55

Frugtkager på mørdej

160 - 170

40 - 80

Forvarm den tomme ovn.

Brug funktionen: Over-/undervarme.

Brug en bradepande.

**KAGER/
BAGVÆRK/BRØD****(°C)****(min.)**

Roulade

180 - 200

10 - 20

3

Rugbrød:

først: 230
så: 160 - 18020
30 - 60

1

Smørmandelkage / Sukkerkage

190 - 210

20 - 30

3

Flødeboller / Flødekager

190 - 210

20 - 35

3

Fletbrød / Kringle

170 - 190

30 - 40

3

Frugttærter (på gærdej/
rørt kagedej), brug en bradepande

170

35 - 55

3

Gærkager med blødt fyld
(f.eks. kvark, fløde, creme)

160 - 180

40 - 80

3

Stollen

160 - 180

50 - 70

2

Brug ovnens tredje ristposition.

**SMÅT BAG-
VÆRK****(°C)****(min.)**

Lagkagebunde af mørdej

Varmluft

150 - 160

10 - 20

Småt gærbrød, forvarm den tomme ovn

Varmluft

160

10 - 25

Lagkagebunde af rørt dej

Varmluft

150 - 160

15 - 20

Småt bagværk af butterdej,
forvarm den tomme ovn

Varmluft

170 - 180

20 - 30

Lagkagebunde af gærdej

Varmluft

150 - 160





20 - 40

Makroner

Varmluft





100 - 120

30 - 50

 SMÅT BAGVÆRK		 (°C)	 (min.)
Marengs / Marengs	Varmluft	80 - 100	120 - 150
Småt gærbrød, forvarm den tomme ovn	Over-/undervarme	190 - 210	10 - 25

9.6 Souffleer og gratiner





Brug ovnens første ristposition.





		 (°C)	 (min.)
Småt gærbrød med smeltet ost	Varmluft	160 - 170	15 - 30
Grøntsagsgratin, forvarm den tomme ovn	Turbo grill	160 - 170	15 - 30
Lasagne	Over-/undervarme	180 - 200	25 - 40
Fiskegratiner	Over-/undervarme	180 - 200	30 - 60
Fyldte grøntsager	Varmluft	160 - 170	30 - 60
Søde souffleer	Over-/undervarme	180 - 200	40 - 60
Pastaretter	Over-/undervarme	180 - 200	45 - 60





9.7 Bagning på flere ribber

Brug funktionen: Varmluft.

Brug bagepladerne.

 KAGER/BAGVÆRK	 (°C)	 (min.)	 2 riller
Flødeboller / Flødekager, forvarm den tomme ovn	160 - 180	25 - 45	1 / 4
Toscatærte, tør	150 - 160	30 - 45	1 / 4

 SMÅT BAGVÆRK/SMÅ KAGER/BOLLER	 (°C)	 (min.)	 2 riller	 3 riller
Småt gærbrød	180	20 - 30	1 / 4	-

 SMÅT BAGVÆRK/SMÅ KAGER/BOLLER	 (°C)	 (min.)	 2 riller	3 riller
Lagkagebunde af mørdej	150 - 160	20 - 40	1 / 4	1 / 3 / 5
Lagkagebunde af rørt dej	160 - 170	25 - 40	1 / 4	-
Småt bagværk af butterdej, forvarm den tomme ovn	170 - 180	30 - 50	1 / 4	-
Lagkagebunde af gærdej	160 - 170	30 - 60	1 / 4	-
Makroner	100 - 120	40 - 80	1 / 4	-
Marengs / Marengs	80 - 100	130 - 170	1 / 4	-

9.8 Tips til stegning

Brug varmeresistent ovngrej.

Steg magert kød tildækket (du kan bruge aluminiumsfolie).

Steg store stege direkte i fadet eller på grillristen over fadet.

Hæld noget vand i bakken for at forhindre, at dryppende fedt brænder.







Vend stegen efter 1/2 - 2/3 af tilberedningstiden.

Steg kød og fisk i store stykker (1 kg eller mere).

Dryp stege med deres egen saft adskillige gange under stegning.

9.9 Stegning

Brug ovnens første ristposition.

 OKSEKØD				 (°C)	 (min.)
Grydesteg	1 - 1,5 kg	Over-/undervarme	230	120 - 150	
Roastbeef eller filet, rød, forvarm den tomme ovn	pr. cm i højden	Turbo grill	190 - 200	5 - 6	
Roastbeef eller filet, medium, forvarm den tomme ovn	pr. cm i højden	Turbo grill	180 - 190	6 - 8	
Roastbeef eller filet, gennemstegt, forvarm den tomme ovn	pr. cm i højden	Turbo grill	170 - 180	8 - 10	



SVIN



Brug funktionen: Turbo grill.



(kg)



(°C)



(min.)

	(kg)	(°C)	(min.)
Bov / Nakke / Skinke m. ben	1 - 1.5	160 - 180	90 - 120
Koteletter / Spareribs	1 - 1.5	170 - 180	60 - 90
Farsbrød	0.75 - 1	160 - 170	50 - 60
Svineskank, forkogt	0.75 - 1	150 - 170	90 - 120



KALVEKØD



Brug funktionen: Turbo grill.



(kg)



(°C)



(min.)

	(kg)	(°C)	(min.)
Kalvesteg	1	160 - 180	90 - 120
Kalveskank	1.5 - 2	160 - 180	120 - 150



LAMMEKØD



Brug funktionen: Turbo grill.



(kg)



(°C)



(min.)

	(kg)	(°C)	(min.)
Lammekølle / Lammesteg	1 - 1.5	150 - 170	100 - 120
Lammeryg	1 - 1.5	160 - 180	40 - 60



VILDT



Brug funktionen: Over-/undervarme.



(kg)



(°C)



(min.)

Ryg / Harekølle, forvarm den tomme ovn

op til 1

230

30 - 40

Vildtryg

1.5 - 2

210 - 220

35 - 40

Kølle

1.5 - 2

180 - 200

60 - 90



FJERKRÆ



Brug funktionen: Turbo grill.



(kg)



(°C)



(min.)

Udskåret fjerkræ

0,2 - 0,25 hver

200 - 220

30 - 50

Fjerkræ, halveret

0,4 - 0,5 hver

190 - 210

35 - 50

Kylling, poulard

1 - 1.5

190 - 210

50 - 70

And

1.5 - 2

180 - 200

80 - 100

Gås

3.5 - 5

160 - 180

120 - 180

Kalkun

2.5 - 3.5

160 - 180

120 - 150

Kalkun

4 - 6

140 - 160

150 - 240



FISK (DAMPNING)



Brug funktionen: Over-/undervarme.



(kg)



(°C)



(min.)

Hel fisk

1 - 1.5



210 - 220

40 - 60

9.10 Sprød tilberedning med: Pizza-funktionen

 PIZZA



 Brug ovnens første ristposition.

	 (°C)	 (min.)
Tærter	180 - 200	40 - 55
Spinattærte	160 - 180	45 - 60
Quiche lorraine / Schweizisk tærte	170 - 190	45 - 55
Kvarkkage	140 - 160	60 - 90
Grøntsagstærte	160 - 180	50 - 60

 PIZZA

 Forvarm den tomme ovn inden tilberedning.



 Brug ovnens anden ristposition.

	 (°C)	 (min.)
Pizza, tynd bund, brug en bradepande	200 - 230	15 - 20

 PIZZA

 Forvarm den tomme ovn inden tilberedning.

 Brug ovnens anden ristposition.

	 (°C)	 (min.)
Pizza, tyk bund	180 - 200	20 - 30
Flade madbrød	230 - 250	10 - 20
Tærte m/butterdej	160 - 180	45 - 55
Flammkuchen	230 - 250	12 - 20
Pirogger	180 - 200	15 - 25

9.11 Grill

Forvarm den tomme ovn inden tilberedning.

Grillsteg kun tynde stykker af kød eller fisk.

Anbring en plade på den første ristposition for at opsamle fedt.



GRILL



Brug funktionen: Grill



(°C)



(min.)
1. side



(min.)
2. side



	(°C)	(min.) 1. side	(min.) 2. side	
Roastbeef	210 - 230	30 - 40	30 - 40	2
Oksefilet	230	20 - 30	20 - 30	3
Svinekam	210 - 230	30 - 40	30 - 40	2
Kalvekam	210 - 230	30 - 40	30 - 40	2
Lammetryg	210 - 230	25 - 35	20 - 25	3
Hel fisk, 0,5 kg - 1 kg	210 - 230	15 - 30	15 - 30	3 / 4

9.12 Frosne madvarer



OPTØNING



Brug funktionen: Varmluft.



(°C)



(min.)



	(°C)	(min.)	
Pizza, frossen	200 - 220	15 - 25	2
Deep pan pizza, frossen	190 - 210	20 - 25	2
Pizza, kold	210 - 230	13 - 25	2
Pizza snacks, frosne	180 - 200	15 - 30	2
Pommes frites, tynde	200 - 220	20 - 30	3
Pommes frites, tykke	200 - 220	25 - 35	3
Kartoffelbåde / Kroketter	220 - 230	20 - 35	3
Brasede kartofler	210 - 230	20 - 30	3
Lasagne / Cannelloni, frisk	170 - 190	35 - 45	2
Lasagne / Cannelloni, frossen	160 - 180	40 - 60	2
Bagt ost	170 - 190	20 - 30	3
Kyllingevinger	190 - 210	20 - 30	2





9.13 Optøning

Tag maden ud af emballagen og læg den på en tallerken.

Tilbered ikke maden, da dette kan forlænge optøningstiden.

Brug ovnens første ristposition.

For store portioner mad anbringes en omvendt tom tallerken på bunden af ovnrummet. Læg maden i et dybt fad, og stil det oven på tallerkenen i ovnen. Tag om nødvendigt ovnribberne ud.

	 (kg)	 (min.) Optøningstid	 (min.) Yderligere optøningstid	
Kylling	1	100 - 140	20 - 30	Vendes undervejs.
Kød	1	100 - 140	20 - 30	Vendes undervejs.
Ørred	0.15	25 - 35	10 - 15	-
Jordbær	0.3	30 - 40	10 - 20	-
Smør	0.25	30 - 40	10 - 15	-
Fløde	2 x 0,2	80 - 100	10 - 15	Pisk fløden, mens den stadig er lidt frossen nogle steder.
Kage	1.4	60	60	-

9.14 Henkogning

Brug funktionen Undervarme.

Brug kun standardhenkogningsglas i samme størrelse.

Brug ikke glas med skrue- og bajonetlåg eller metaldåser.

Brug ovnens første ristposition.

Stil højst seks 1 liters henkogningsglas på bagepladen.





Fyld glassene ens og luk med en bøjle.



Glassene må ikke røre hinanden.

Hæld ca. 1/2 liter vand på bagepladen, så luften i ovnen er tilstrækkelig fugtig.

Sluk for ovnen, eller sæt temperaturen ned til 100 °C, når væsken i glassene begynder at simre (i 1 liter-glas efter ca. 35 - 60 minutter) (se tabellen).

Indstil temperaturen til 160 - 170 °C.

 BLØD FRUGT	 (min.) Henkogning til simring	
Jordbær / Blåbær / Hindbær / Modne stikkelsbær	35 - 45	
 STENFRUGT	 (min.) Henkogning til simring	 (min.) Kog færdig ved 100 °C
Ferskner / Kvæder / Blommer	35 - 45	10 - 15

 GRØNTSA-GER	 (min.) Henkogning til simring	 (min.) Kog færdig ved 100 °C
Gulerødder	50 - 60	5 - 10
Agurker	50 - 60	-
Blandet pickles	50 - 60	5 - 10
Kålraabi / Ærter / Asparges	50 - 60	15 - 20

9.15 Dehydrering - Varmluft

Dæk bakkerne med fedtæt papir eller bagepapir.

For at opnå et bedre resultat skal du stoppe ovnen halvvejs gennem tørretiden, åbne døren og lade den køle af én nat for at afslutte tørringen.

Brug den tredje rille til 1 plade.

Brug den første og fjerde rille til 2 plader.

9.16 Fugtig varmluft - anbefalet tilbehør

Brug mørke og ikke-reflekterende former og beholdere. De har en bedre varmeabsorbering end lyse og reflekterende fade.



Pizzaform

Mørk, ikke-reflekterende
28 cm diameter

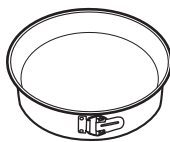

Bageform

Mørk, ikke-reflekterende
26 cm diameter



Ramekiner

Keramisk
8 cm diameter, 5
cm højde

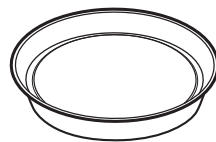



Tærtbundform



Mørk, ikke-reflekterende
28 cm diameter





9.17 Fugtig varmluft

For at få de bedste resultater skal du følge forslagene angivet på nedenstående tabel.

 GRØNTSA-GER	 (°C)	 (t)
Bønner	60 - 70	6 - 8
Peberfrugt	60 - 70	5 - 6
Suppegrøntsager	60 - 70	5 - 6
Champignons	50 - 60	6 - 8
Krydderurter	40 - 50	2 - 3







Indstil temperaturen til 60 - 70 °C.

 FRUGT	 (t)
Blommer	8 - 10
Abrikoser	8 - 10
Æble, i skiver	6 - 8
Ærter	6 - 9

		 (°C)		 (min.)
Søde boller, 16 stk.	bageplade eller bradepande	190	3	45 - 55
Pizza, frossen, 0,35 kg	grillrist	190	2	45 - 50
Roulade	bageplade eller bradepande	180	2	45 - 55
Brownie	bageplade eller bradepande	180	2	55 - 60
Sukkerbund til tærte	flanform på grillrist	180	2	40 - 50
Pocheret fisk, 0,3 kg	bageplade eller bradepande	180	3	25 - 35
Hel fisk, 0,2 kg	bageplade eller bradepande	180	3	25 - 35
Fiskefilet, 0,3 kg	pizzaform på rist	180	3	40 - 50
Pocheret kød, 0,25 kg	bageplade eller bradepande	190	3	40 - 50
Shashlik, 0,5 kg	bageplade eller bradepande	190	3	35 - 45
Cookies, 16 stk.	bageplade eller bradepande	160	2	40 - 50
Makroner, 24 stk.	bageplade eller bradepande	150	2	35 - 45
Muffins, 12 stk.	bageplade eller bradepande	160	2	35 - 45
Madtærte, 20 stk.	bageplade eller bradepande	170	2	35 - 45
Småkager af mørdej, 20 stk.	bageplade eller bradepande	150	2	40 - 45
Små tærter, 8 stk.	bageplade eller bradepande	170	2	35 - 45
Grøntsager, pocherede, 0,4 kg	bageplade eller bradepande	180	3	45 - 55
Vegetarisk omelet	pizzaform på rist	190	3	40 - 50

9.18 Oplysninger til testinstitutter

Tests i overensstemmelse med: EN 60350, IEC 60350.

 BAGNING PÅ ÉN RIBBE. Bagværk i form				
		 (°C)	 (min.)	
Sandkage uden fedt	Varmluft	140 - 150	35 - 50	2
Sandkage uden fedt	Over-/undervarme	160	35 - 50	2
Æbletærte, 2 forme Ø20 cm	Varmluft	160	60 - 90	2
Æbletærte, 2 forme Ø20 cm	Over-/undervarme	180	70 - 90	1



BAGNING PÅ ÉN RIBBE. Småkager



Brug ovnsens tredje ristposition.



(°C)



(min.)

Smørkager / Kagesnitter	Varmluft	140	25 - 40
Smørkager / Kagesnitter, forvarm den tomme ovn	Over-/undervarme	160	20 - 30
Små kager i form, 20 stk./plade, forvarm den tomme ovn	Varmluft	150	20 - 35
Små kager i form, 20 stk./plade, forvarm den tomme ovn	Over-/undervarme	170	20 - 30



BAGNING PÅ FLERE RIBBER. Småkager



(°C)



(min.)



Smørkager / Kagesnitter	Varmluft	140	25 - 45	1 / 4
Små kager i form, 20 stk./plade, forvarm den tomme ovn	Varmluft	150	23 - 40	1 / 4
Sandkage uden fedt	Varmluft	160	35 - 50	1 / 4



GRILL



Forvarm den tomme ovn i 5 minutter.



Grill med den maksimale temperaturindstilling.



(min.)



Toastbrød	Grill	1 - 3	5
Oksesteak, vendes undervejs	Grill	24 - 30	4

10. VEDLIGEHOLDELSE OG RENGØRING



ADVARSEL!

Se kapitlerne om sikkerhed.

10.1 Bemærkninger om rengøring



Rengøringsmidler

Rengør ovnens front med en blød klud opvredet i varmt vand tilsat et rengøringsmiddel.

Brug en rengøringsopløsning for at rengøre metaloverflader.

Rengør pletter med et mildt rengøringsmiddel.



Hverdagsbrug

Rengør altid ovnrummet efter brug. Ophobning af fedt eller andre rester kan medføre en brand.

Opbevar ikke madvarer i ovnen i mere end 20 minutter. Tør ovnrummet med en blød klud efter hver brug.



Tilbehør

Rengør alt tilbehør efter hver brug og lad det tørre. Brug en blød klud opvredet i varmt vand tilsat et mildt rengøringsmiddel. Tilbehøret må ikke vaskes i opvaskemaskinen.

Rengør ikke slip-tilbehøret med slibende rengøringsmiddel eller skarpe genstande.

10.2 Fjernelse: Ovnribber

Fjern ovnribberne, så ovnen kan rengøres.

Trin 1 Sluk for ovnen, og vent, til den er kold.

Trin 2 Træk forenden af ribben væk fra sidevæggen.

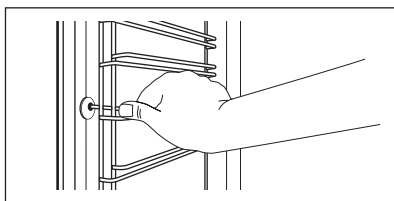

Trin 3 Træk den bageste ende af ovnribben væk fra sidevæggen, og fjern den.

Trin 4 Montér ovnribberne i omvendt rækkefølge.

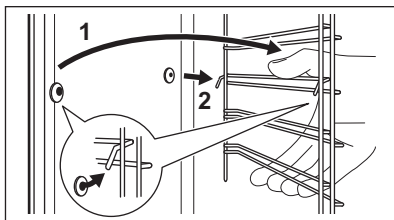

10.3 Fjernelse: Grill



ADVARSEL!

Der er risiko for forbrænding.

- Trin 1** Sluk for ovnen, og vent, til den er kold for at rengøre den.
Tag ovnribberne ud.
-
- Trin 2** Tag fat i grillhjørnerne. Træk den fremad mod fjedertrykket og ud af de to holdere. Grillen foldes ned.
-
- Trin 3** Rengør ovnloftet med lunkent vand, en blød klud og et mildt rengøringsmiddel. Lad det tørre.
-
- Trin 4** Montér grillen i omvendt rækkefølge.

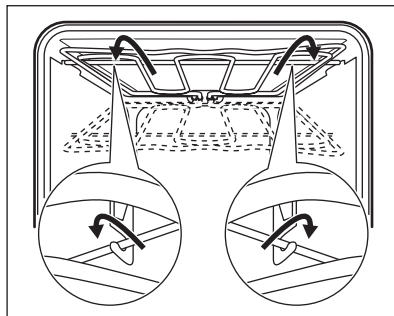

-
- Trin 5** Montér ovnribberne.
-

10.4 Fjernelse og installation: Låge

Du kan tage lågen og det indvendige ovnglas ud for at rengøre det. Antallet af glaspaneler er forskelligt for forskellige modeller.



ADVARSEL!

Døren er tung.

- Trin 1** Åbn lågen helt.
-
- Trin 2** Løft og tryk låsegrebene (A) helt på de to lågehængsler.



FORSIGTIG!

Håndter forsigtigt glasset, især omkring frontpanelets kanter. Glasset kan gå i stykker.

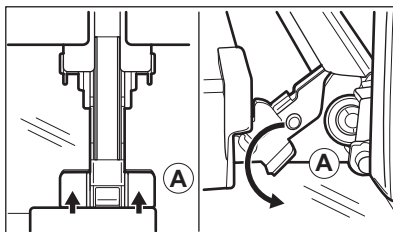

-
- Trin 3** Sæt overlågen i den første tætte position (vinkel på ca. 70°). Hold lågen i begge sider, og træk den væk fra ovnen i en vinkel opad. Læg lågen med ydersiden nedad på en blød klud på et stabilt underlag.
-

Trin 4	Hold i begge sider af lågelisten (B) i lågens overkant, og tryk indad, indtil låsehagen slipper.	
Trin 5	Træk lågelisten fremad, og tag den ud.	
Trin 6	Hold i overkanten af hvert enkelt ovnglas, og træk det opad og ud af skinnen.	
Trin 7	Rengør glaspanelet med vand og sæbe. Tør ovnglasset forsigtigt. Ovnglasset må ikke komme i opvaske maskinen.	
Trin 8	Udfør ovennævnte trin i omvendt rækkefølge efter rengøring.	
Trin 9	Sæt det mindste glas i først og derefter det største og lågen. Sørg for, at glassene er sat i den rigtige position, da lågens overflade ellers kan blive overophedet.	

10.5 Udskiftning: Lampe



ADVARSEL!

Risiko for elektrisk stød
Pæren kan være varm.

Før du udskifter pæren:

Trin 1	Trin 2	Trin 3
Sluk for ovnen. Vent, til ovnen er kold.	Tag stikket ud af kontakten.	Læg en klud i bunden af ovnrummet.

Toplampe

Trin 1 Drej glasset, og tag det af.

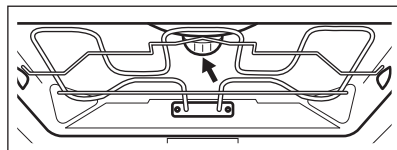

Trin 2 Gør glasset rent.

Trin 3 Udskift pæren med en passende 300 ° C varmebestandig pære.

Trin 4 Montér dækglasset.

11. FEJLFINDING



ADVARSEL!

Se kapitlerne om sikkerhed.

11.1 Hvis noget går galt

I eventuelle tilfælde, der ikke er inkluderet i denne tabel, bedes du kontakte et autoriseret servicecenter.

Problem	Kontroller, at ...
Ovnen bliver ikke varm.	Sikringen er sprunget.
Pæren lyser ikke.	Pæren er sprunget.

11.2 Serviceoplysninger

Kontakt forhandleren eller et autoriseret servicecenter, hvis du ikke selv kan løse problemet.

De nødvendige oplysninger til servicecenteret er angivet på typeskiltet. Typeskiltet er placeret på ovnrummets frontramme. Typeskiltet må ikke fjernes fra ovnrummet.

Det anbefales, at du noterer oplysningerne her:

Model (MOD.)
Produktnummer (PNC)
Serienummer (S.N.)

12. ENERGIEFFEKTIV

12.1 Produktinformation og produktinformationsark*

Leverandørens navn	AEG
Identifikation af model	EEB230010M 940321361
Energieffektivitetsindeks	95.3
Energieffektivitetsklasse	A
Energiforbrug med en standardmængde, almindelig tilstand	0.99 kWh/cyklus
Energiforbrug med en standardmængde, blæsertungen tilstand	0.81 kWh/cyklus
Antal ovnrør	1
Varmekilde	Elektricitet
Volumen	71 l
Type ovn	Underbygningsovn
Vægt	31.5 kg

* For EU ifølge EU-forordninger 65/2014 og 66/2014.

For Hviderusland ifølge STB 2478-2017, bilag G; STB 2477-2017, bilag A og B.

For Ukraine ifølge 568/32020.

Energieffektivitetsklasse gælder ikke for Rusland.

12.2 Energibesparelse



Ovnen indeholder funktioner, som hjælper dig med at spare energi ved daglig madlavning.

Sørg for, at ovnlågen er lukket, når ovnen bruges. Åbn ikke lågen for ofte under tilberedningen. Hold dørpakningen ren og sørg for, at den sidder godt fast.

Brug køkkengrej af metal for at øge energibesparelsen.

Forvarm om muligt ikke ovnen inden tilberedning.

Hold pauserne mellem bagning så korte som muligt, når du tilbereder nogle få retter på én gang.

Tilberedning med blæser

Brug om muligt tilberedningsfunktionerne med blæser for at spare energi.

Restvarme

Når tilberedningsvarigheden er længere end 30 min., skal du reducere ovntemperaturen til minimum 3 - 10 min. inden afslutningen af tilberedningen. Restvarmen i ovnen bliver ved med at tilberede maden.

Brug restvarmen til at opvarme andre retter.

Hold maden varm

Vælg den lavest mulige temperaturindstilling for at bruge restvarme og holde et måltid varmt.

Fugtig varmluft

Denne funktion er beregnet til at spare energi under madlavning.

13. MILJØHENSYN

Genbrug materialer med symbolet . Anbring emballagematerialet i passende beholdere til genbrug. Hjælp med at beskytte miljøet og menneskelig sundhed samt at genbruge affald af elektriske og elektroniske apparater. Kasser ikke apparater, der er

mærket med symbolet  sammen med husholdningsaffaldet. Lever produktet tilbage til din lokale genbrugsplads eller kontakt din kommune.

VOOR PERFECTE RESULTATEN

Bedankt dat je voor dit AEG-product hebt gekozen. We hebben het gecreëerd om jarenlang onberispelijke prestaties te leveren, met innovatieve technologieën die het leven eenvoudiger maken – functies die je wellicht niet op gewone apparaten aantreft. Neem een paar minuten de tijd om het beste uit het apparaat te halen.

Ga naar onze website voor:



Advies over gebruik, brochures, het oplossen van problemen, service- en reparatie-informatie:

www.aeg.com/support



Registreer je product voor een betere service:

www.registeraeg.com



Koop accessoires, verbruiksartikelen en originele reserveonderdelen voor je apparaat:

www.aeg.com/shop

KLANTENSERVICE EN SERVICE

Gebruik altijd originele onderdelen.

Als u contact opneemt met onze erkende servicedienst, zorg er dan voor dat u de volgende gegevens tot uw beschikking hebt: Model, PNC, serienummer.

De informatie vindt u op het typeplaatje.

 Waarschuwingen en veiligheidsinformatie

 Algemene informatie en tips

 Milieu-informatie

Wijzigingen voorbehouden.

INHOUDSOPGAVE

1. VEILIGHEIDSINFORMATIE.....	29
2. VEILIGHEIDSVOORSCHRIFTEN.....	31
3. BESCHRIJVING VAN HET PRODUCT.....	34
4. BEDIENINGSPANEEL.....	35
5. VOORAFGAAND AAN HET EERSTE GEBRUIK.....	35
6. DAGELIJKS GEBRUIK.....	36
7. GEBRUIK VAN DE ACCESSOIRES.....	37
8. EXTRA FUNCTIES.....	38
9. AANWIJZINGEN EN TIPS.....	38
10. ONDERHOUD EN REINIGING.....	52
11. PROBLEEMOPLOSSING.....	55
12. ENERGIEZUINIGHEID.....	56

1. VEILIGHEIDSINFORMATIE

Lees zorgvuldig de meegeleverde instructies voor installatie en gebruik van het apparaat. De fabrikant is niet

verantwoordelijk voor verwondingen of schade die voortvloeit uit de onjuiste installatie of het onjuiste gebruik. Bewaar de instructies altijd op een veilige, toegankelijke plek voor toekomstig gebruik.

1.1 De veiligheid van kinderen en kwetsbare personen

- Dit apparaat kan worden gebruikt door kinderen van 8 jaar en ouder en door mensen met een beperkt lichamelijk, zintuiglijk of verstandelijk vermogen of een gebrek aan ervaring en kennis, indien zij onder toezicht staan of instructies hebben gekregen over het veilig gebruiken van het apparaat en indien zij de gevaren begrijpen. Kinderen jonger dan 8 jaar en personen met zware en complexe beperkingen dienen altijd uit de buurt van het apparaat te worden gehouden, tenzij ze voortdurend onder toezicht staan.
- Houd toezicht op kinderen om te voorkomen dat zij met het apparaat gaan spelen..
- Houd alle verpakking uit de buurt van kinderen en gooi het op passende wijze weg.
- **WAARSCHUWING:** Houd kinderen en huisdieren uit de buurt van het apparaat als die in werking is of afkoelt. Makkelijk toegankelijke onderdelen worden heet tijdens het gebruik.
- Als het apparaat is voorzien van een kinderslot, dient dit te worden geactiveerd.
- Kinderen mogen zonder toezicht geen reinigings- en onderhoudswerkzaamheden aan het apparaat uitvoeren.

1.2 Algemene veiligheid

- Alleen een erkende installatietechnicus mag dit apparaat installeren en de kabel vervangen.
- Gebruik het apparaat niet voordat u het in de ingebouwde constructie installeert.
- Trek de stekker van het apparaat uit het stopcontact voordat u welke soort onderhoud dan ook gaat uitvoeren.

- Als het netsnoer beschadigd is, moet de fabrikant, een erkende serviceverlener of een gekwalificeerd persoon deze vervangen teneinde gevaarlijke situaties te voorkomen.
- Het bedieningspaneel moet om mogelijke gevaren te voorkomen worden aangesloten op de aangegeven verwarmingseenheid met overeenkomende connectorkleuren.
- De middelen voor het uitschakelen moeten opgenomen worden in de vaste bedrading overeenkomstig de regels voor de bedrading.
- **WAARSCHUWING:** Zorg ervoor dat het apparaat is uitgeschakeld voordat u de lamp vervangt om elektrische schokken te voorkomen.
- **WAARSCHUWING:** Het apparaat en de toegankelijke onderdelen ervan worden heet tijdens gebruik. U dient te voorkomen de verwarmingselementen aan te raken.
- Gebruik altijd ovenhandschoenen om accessoires of kookgerei te plaatsen of verwijderen.
- Om de inschuifrails te verwijderen trekt u eerst de voorkant van de inschuifrail en dan de achterkant uit de zijwanden. Installeer de inschuifrails in de omgekeerde volgorde.
- Gebruik geen stoomreiniger om het apparaat schoon te maken.
- Gebruik nooit agressieve reinigingsmiddelen of scherpe metalen schrappers om de glazen deur schoon te maken, deze kunnen krassen veroorzaken op het oppervlak, waardoor het glas zou kunnen breken.

2. VEILIGHEIDSVOORSCHRIFTEN

2.1 Installeren



WAARSCHUWING!

Alleen een erkende installatietechnicus mag het apparaat installeren.

- Verwijder alle verpakkingsmaterialen.

- Installeer en gebruik geen beschadigd apparaat.
- Volg de installatie-instructies die zijn meegeleverd met het apparaat.
- Pas altijd op bij verplaatsing van het apparaat, want het is zwaar. Gebruik altijd veiligheidshandschoenen en gesloten schoeisel.

- Trek het apparaat nooit aan de handgreep van zijn plaats.
- Installeer het apparaat op een veilige en geschikte plaats die aan alle installatie-eisen voldoet.
- De afmetingen van de keukenkast en de uitsparing moeten kloppen.
- Houd de minimumafstand naar andere apparaten en units in acht.
- Controleer, voordat u het apparaat monteert, of de ovendeur onbelemmerd opengaat.
- Delen van het apparaat staan onder stroom. Sluit het apparaat met meubel om te voorkomen dat de gevaarlijke delen worden aangeraakt.
- Het apparaat is uitgerust met een elektrisch koelsysteem. Het moet worden gebruikt met de elektrische voeding.
- De inbouweenheid moet voldoen aan de stabiliteitsvereisten van DIN 68930.

Minimumhoogte kast (Minimumhoogte kast onder werkblad)	578 (600) mm
Kastbreedte	560 mm
Kastdiepte	550 (550) mm
Hoogte van de voorkant van het apparaat	594 mm
Hoogte van de achterkant van het apparaat	576 mm
Breedte van de voorkant van het apparaat	595 mm
Breedte van de achterkant van het apparaat	559 mm
Diepte van het apparaat	567 mm
Ingebouwde diepte van het apparaat	546 mm
Diepte met open deur	1027 mm
Minimumgrootte ventilatieopening. Opening geplaatst aan de onderkant van de achterzijde	560 x 20 mm
Bevestigingsschroeven	4 x 25 mm

2.2 Elektrische aansluiting



WAARSCHUWING!

Gevaar voor brand en elektrische schokken.

- Alle elektrische aansluitingen moeten door een gediplomeerd elektromonteur worden gemaakt.
- Dit apparaat moet worden aangesloten op een geaard stopcontact.
- Zorg ervoor dat de parameters op het vermogensplaatje overeenkomen met elektrische vermogen van de netstroom.
- Gebruik altijd een juist geïnstalleerd schokbestendig stopcontact.
- Gebruik geen adapters met meerdere stekkers en verlengkabels.
- Zorg dat u de netstekker en het netsnoer niet beschadigt. Indien de voedingskabel moet worden vervangen, dan moet dit gebeuren door onze Klantenservice.
- Laat de stroomkabel niet in aanraking komen met de deur van het apparaat of de niche onder het apparaat, met name niet als deze werkt of als de deur heet is.
- De schokbescherming van delen onder stroom en geïsoleerde delen moet op zo'n manier worden bevestigd dat het niet zonder gereedschap kan worden verplaatst.
- Steek de stekker pas in het stopcontact als de installatie is voltooid. Zorg ervoor dat het netsnoer na installatie bereikbaar is.
- Als het stopcontact los zit, mag u de stekker niet in het stopcontact steken.
- Trek niet aan het netsnoer om het apparaat los te koppelen. Trek altijd aan de stekker.
- Gebruik enkel correcte isolatievoorzieningen: stroomonderbrekers, zekeringen (schroefzekeringen moeten uit de houder worden verwijderd), aardlekschakelaars en contactgevers.
- De elektrische installatie moet een isolatieapparaat bevatten waardoor het apparaat volledig van het lichtnet afgesloten kan worden. Het isolatieapparaat moet een contactopening hebben met een minimale breedte van 3 mm.

- Dit apparaat wordt geleverd zonder een stekker en een netsnoer.

2.3 Gebruik



WAARSCHUWING!

Gevaar voor letsel, brandwonden, elektrische schokken of een explosie.

- Dit apparaat is uitsluitend bestemd voor (binnenshuis) huishoudelijk gebruik.
- De specificatie van dit apparaat niet wijzigen.
- Zorg ervoor dat de ventilatieopeningen niet geblokkeerd worden.
- Laat het apparaat tijdens de werking niet onbeheerd achter.
- Schakel het apparaat na elk gebruik uit.
- Wees voorzichtig met het openen van de deur van het apparaat wanneer het apparaat in werking is. Er kan hete lucht vrijkomen.
- Gebruik het apparaat niet met natte handen of als het contact maakt met water.
- Oefen geen druk uit op de open deur.
- Gebruik het apparaat niet als werkblad of als opslagoppervlak.
- Open de deur van het apparaat voorzichtig. Het gebruik van ingrediënten met alcohol kan een mengsel van alcohol en lucht veroorzaken.
- Laat geen vonken of open vlammen in contact met het apparaat komen wanneer u de deur opent.
- Plaats geen ontvlambare producten of artikelen die vochtig zijn met ontvlambare producten in, bij of op het apparaat.



WAARSCHUWING!

Risico op schade aan het apparaat.

- Om schade of verkleuring van het email te voorkomen:
 - plaats ovenschalen of andere voorwerpen niet rechtstreeks op de bodem van het apparaat.
 - leg geen aluminiumfolie op de bodem van de ruimte in het apparaat.
 - plaats geen water direct in het hete apparaat.

- bewaar geen vochtige gerechten en voedsel in het apparaat nadat u klaar bent met koken.
- wees voorzichtig bij het verwijderen of bevestigen van accessoires.
- Verkleuring van het email of roestvrij staal is niet van invloed op de werking van het apparaat.
- Gebruik een diepe pan voor vochtige taarten. Vruchtensappen veroorzaken vlekken die permanent kunnen zijn.
- Dit apparaat is uitsluitend bestemd om mee te koken. Het mag niet worden gebruikt voor andere doeleinden, bijvoorbeeld het verwarmen van de ruimte.
- Kook altijd met een gesloten oventeur.

2.4 Onderhoud en reiniging



WAARSCHUWING!

Gevaar voor letsel, brand en schade aan het apparaat.

- Schakel het apparaat uit en trek de stekker uit het stopcontact voordat u onderhoudshandelingen verricht.
- Zorg ervoor dat het apparaat is afgekoeld. Er bestaat een risico dat de glasplaten kunnen breken.
- Vervang direct de glazen deurpanelen als deze beschadigd zijn. Neem contact op met een erkend servicecentrum.
- Wees voorzichtig als u de deur van het apparaat verwijdert. De deur is zwaar!
- Reinig het apparaat regelmatig om te voorkomen dat het materiaal van het oppervlak achteruitgaat.
- Maak het apparaat schoon met een vochtige zachte doek. Gebruik alleen neutrale schoonmaakmiddelen. Gebruik geen schuurmiddelen, schuurponsjes, oplosmiddelen of metalen voorwerpen.
- Volg als u een ovenspray gebruikt de aanwijzingen op de verpakking.

2.5 Binnenverlichting



WAARSCHUWING!

Gevaar voor elektrische schokken.

- Met betrekking tot de lamp(en) in dit product en reservelampen die afzonderlijk

worden verkocht: Deze lampen zijn bedoeld om bestand te zijn tegen extreme fysieke omstandigheden in huishoudelijke apparaten, zoals temperatuur, trillingen, vochtigheid, of zijn bedoeld om informatie te geven over de operationele status van het apparaat. Ze zijn niet bedoeld voor gebruik in andere toepassingen en zijn niet geschikt voor verlichting in huishoudelijke ruimten.

- Gebruik alleen lampjes met dezelfde specificaties.

2.6 Service

- Neem contact op met de erkende servicedienst voor reparatie van het apparaat.
- Gebruik uitsluitend originele reserveonderdelen.

2.7 Verwijdering



WAARSCHUWING!

Gevaar voor letsel of verstikking.

- Neem contact op met uw plaatselijke overheid voor informatie over het afvoeren van het apparaat.
- Haal de stekker uit het stopcontact.
- Snijd het netsnoer vlak bij het apparaat af en gooi het weg.
- Verwijder de deurvergrendeling om te voorkomen dat kinderen of huisdieren binnen in het apparaat vast komen te zitten.

3. BESCHRIJVING VAN HET PRODUCT

3.1 Algemeen overzicht

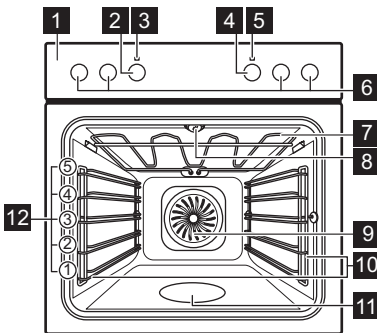

- 1 Bedieningspaneel
- 2 Knop voor verwarmingsfuncties
- 3 Aan-uitlampje/symbool
- 4 Bedieningsknop (voor de temperatuur)
- 5 Temperatuurindicator/symbool
- 6 Knoppen voor de kookzones
- 7 Verwarmingselement
- 8 Lamp
- 9 Ventilator
- 10 Inschuifrails, verwijderbaar
- 11 Uitholling reliëf
- 12 Inzetniveaus

3.2 Accessoires

Bakrooster

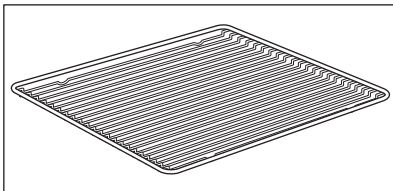

Voor kookgerei, bak- en braadvormen.

Combischaal

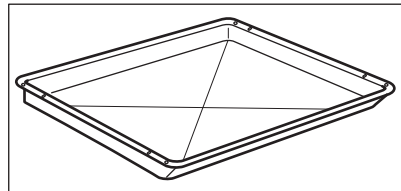

Voor gebak en koekjes. Om te bakken en braden of als een pan om vet in op te vangen.

4. BEDIENINGSPANEEL

4.1 Knoppen voor de kookzones

De kookplaat is te bedienen met de knoppen voor de kookzones.



U dient de hoofdstukken m.b.t Veiligheid te lezen in de gebruiksaanwijzing van de kookplaat.

4.2 Verwarmingsstanden

Knopaanduiding	-functie
0	Uit-stand
	Warmhoudstand
1 - 9	Verwarmingsstanden

1. Draai de bedieningsknop in de gewenste verwarmingsstand.
2. Zet de bedieningsknop op de uit stand om het kookproces te beëindigen.

4.3 Automatisch opwarmen



Aalleen van toepassing voor kookplaten met de automatische verwarmingsfunctie.

De functie Automatisch opwarmen verwarmt de kookzone gedurende enige tijd op volledig vermogen.

1. Draai de knop voor de kookzone zo ver mogelijk naar rechts (voorbij de hoogste kookstand).
2. Stel meteen de benodigde kookstand in.
3. Draai de knop naar de uit-stand om de functie uit te schakelen.

4.4 Gebruik van de dubbele zone (indien van toepassing)



Draai de knop rechtsonder om de dubbele zone te activeren. Draai de knop niet verder dan de stoppositie.

1. Draai de knop rechtsonder naar stand 9.
2. Draai de knop langzaam tot u een klik hoort. De twee kookzones zijn aan.
3. Raadpleeg 'Verwarmingsstanden' om de nodige verwarmingsstanden in te stellen.

5. VOORAFGAAND AAN HET EERSTE GEBRUIK



WAARSCHUWING!

Raadpleeg de hoofdstukken Veiligheid.

5.1 Voorafgaand aan het eerste gebruik

De oven kan een vreemde geur en rook afgeven tijdens het voorverwarmen. Zorg ervoor dat de kamer goed is geventileerd.



Stap 1



De oven reinigen

1. Haal alle accessoires en verwijderbare inschuifrails uit de oven.
2. Reinig de oven en de accessoires met een zachte doek, warm water en een mild reinigingsmiddel.



Stap 2

Verwarm de lege oven voor

1. Stel de maximale temperatuur in voor de functie:  Tijd: 1 uur
2. Stel de maximale temperatuur in voor de functie:  Tijd: 15 min

Schakel de oven uit en wacht tot deze is afgekoeld. Plaats de accessoires en de verwijderbare inschuifrails in de oven.

6. DAGELIJKS GEBRUIK



WAARSCHUWING!

Raadpleeg de hoofdstukken Veiligheid.

6.1 Instellen: Verwarmingsfunctie

- Stap 1** Draai aan de knop voor de verwarmingsfuncties om een verwarmingsfunctie te selecteren.
- Stap 2** Draai aan de regelknop om de temperatuur te selecteren.
- Stap 3** Draai wanneer het bereiden stopt aan de knoppen naar de uit-stand om de oven uit te schakelen.

6.2 Verwarmingsfuncties

Verwarmingsfunctie	Toepassing
--------------------	------------

0

Uit-stand

De oven is uit.



Binnenverlichting

Inschakelen van de verlichting.

Verwarmingsfunctie

Toepassing



Hotelucht

Bakken op maximaal drie rekstanden tegelijkertijd en voedsel drogen.
Stel de temperatuur 20 - 40 °C lager in dan voor Boven- /onderwarmte.



Pizza-functie

Voor het bakken van pizza.
Voor intensieve bruining en een krokante bodem.



Boven- /onderwarmte

Voor het bakken en roosteren op één ovenniveau.



Onderwarmte

Voor het bakken van taarten met een krokante bodem en het bewaren van voedsel.



Ontdooien

Om voedsel te ontdooien (groenten en fruit). De ontdooitijd is afhankelijk van de hoeveelheid ingevroren voedsel en de grootte daarvan.

Verwarmings- functie	Toepassing
-------------------------	------------



Warmelucht (vochtig)

Deze functie is ontworpen om tijdens de bereiding energie te besparen. Bij het gebruik van deze functie kan de temperatuur in de ruimte verschillen van de ingestelde temperatuur. Het verwarmingsvermogen kan worden verminderd. Raadpleeg voor meer informatie het hoofdstuk "Dagelijks gebruik", opmerkingen op: Warmelucht (vochtig) .



Grill

Om dunne stukken voedsel te grillen en brood te roosteren.



Turbo grill

Voor het braden van grote stukken vlees of gevogelte met bot op één niveau. Voor gratineren en bruinen.



De lamp kan tijdens bepaalde ovenfuncties automatisch uitgaan bij een temperatuur die lager is dan 60° C.

6.3 Toelichting van: Warmelucht (vochtig)

Deze functie wordt gebruikt om te voldoen aan de energie-efficiëntieklasse en ecodesign-vereisten overeenkomstig EU 65/2014 en EU 66/2014. Testen volgens EN 60350-1.

De ovendeur dient tijdens de bereiding gesloten te zijn zodat de functie niet wordt onderbroken en de oven werkt op de hoogst mogelijke energie-efficiëntie.

Raadpleeg voor de kookinstructies het hoofdstuk "Aanwijzingen en tips", Warmelucht (vochtig) . Raadpleeg voor algemene aanbevelingen voor energiebesparing het hoofdstuk "Energie-efficiëntie", Energiebesparing.

7. GEBRUIK VAN DE ACCESSOIRES



WAARSCHUWING!

Raadpleeg de hoofdstukken Veiligheid.

7.1 Accessoires plaatsen

Een kleine inkeping bovenaan verhoogt de veiligheid. Deze inkepingen voorkomen

bovendien omkanteling. De hoge rand rond het rooster voorkomt dat het kookgerei van het rooster afglijdt.

Bakrooster:

Plaats het rooster tussen de geleidestangen van de inschuifrail.

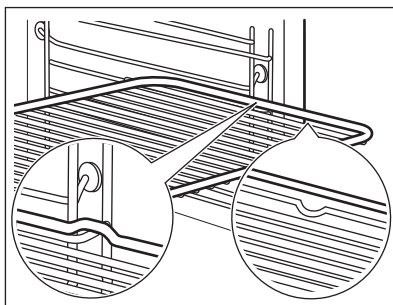
**Braadpan:**

Schuif de plaat tussen de geleidestangen van de inschuifrail.

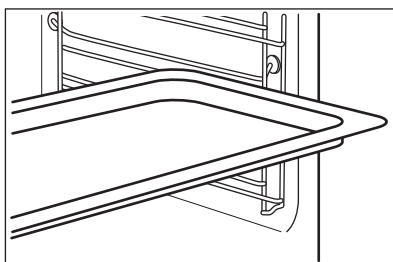
**Bakrooster, Braadpan:**

Plaats de plaat tussen de geleiders van de inschuifrails en het bakrooster op de geleiders erboven.

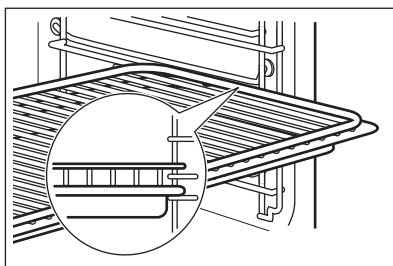

8. EXTRA FUNCTIES

8.1 Koelventilator

Als de oven in werking is, wordt de koelventilator automatisch ingeschakeld om de oppervlakken van de oven koel te

houden. Als u de oven uitschakelt, kan de koelventilator blijven werken totdat de oven is afgekoeld.

9. AANWIJZINGEN EN TIPS



Raadpleeg de hoofdstukken
Veiligheid.

9.1 Voorbeelden van kooktoepassingen voor de kookplaat

Kookstand	Applicatie	Tijd (min)	Tips
1	Om eten warm te houden.	naar behoefte	Een deksel op het kookgerei doen.
1 - 2	Voor het maken van Hollandaise saus en om boter, chocolade en gelatine te laten smelten.	5 - 25	Mixen met tussenpozen.
1 - 2	Om luchtige omeletten en gebakken eieren te laten stollen.	10 - 40	Met deksel bereiden
2 - 3	Om rijst en gerechten op melkbasis te laten sudderen en om kant-en-klaargerechten op te warmen.	25 - 50	Voeg minimaal twee keer zoveel vloeistof toe dan rijst. Roer de melkgerechten halverwege goed door.
3 - 4	Voor het stomen van groenten, vis en vlees.	20 - 45	Voeg een paar eetlepels vocht toe.
4 - 5	Om aardappelen te stomen.	20 - 60	Gebruik maximaal ¼ l water voor 750 g aardappelen.
4 - 5	Voor het bereiden van grotere hoeveelheden voedsel, stoofschotels en soepen.	60 - 150	Voeg maximum 3 l vloeistof toe aan de ingrediënten.
6 - 7	Voor het licht aanbraden van kalfslappen, kalfsvlees cordon bleu, rissoles, sauzen, roux, eieren, pannenkoeken, donuts.	naar behoefte	Halverwege de bereidingstijd omdraaien.
7 - 8	Voor het opbakken van aardappelen en het bakken van lendenbiefstukken en steaks.	5 - 15	Halverwege de bereidingstijd omdraaien.
9	Voor het aan de kook brengen van grotere hoeveelheden water, pasta koken, aanbraden van vlees (goulash, stoofvlees), frituren van friet.		

9.2 Kookadviezen



De temperatuur en kooktijden in de tabellen zijn slechts als richtlijn bedoeld. Deze zijn afhankelijk van de recepten en de kwaliteit en de hoeveelheid van de gebruikte ingrediënten.

Uw oven kan anders bakken of roosteren dan de oven die u tot nu toe gebruikt heeft. De onderstaande tabellen tonen aanbevolen instellingen voor temperatuur, kooktijd en rekstand voor specifieke soorten voedsel.

Als u voor een speciaal recept de instelling niet kunt vinden, zoek dan naar een soortgelijk recept.

9.3 Bakken

Gebruik voor de eerste baksessie de lagere temperatuur.

Bij het bereiden van cake op meerdere niveaus kan de baktijd ca. 10 - 15 minuten langer zijn.

Als de cake niet overal even hoog is, wordt de cake niet overal even bruin. Als de cake





niet overal even bruin wordt, hoeft u de temperatuurinstelling niet te wijzigen. De verschillen verminderen tijdens het bakken.

Tijdens het bakken kunnen bakplaten in de oven vervormen. Wanneer de bakplaten weer afgekoeld zijn, verdwijnt de vervorming.

9.4 Baktips

Bakresultaat	Mogelijke oorzaak	Oplossing
De onderkant van de cake is niet voldoende gebakken.	De rekstand is incorrect.	Plaats de cake op een lagere rekstand.
De cake zakt in en wordt klef, of streperig.	De oventemperatuur is te hoog.	Stel de volgende keer de oventemperatuur iets lager in.
	De oventemperatuur is te hoog en de baktijd te kort.	Stel volgende keer een langere baktijd en een lagere oventemperatuur in.
De cake is te droog.	De oventemperatuur is te laag.	Stel de volgende keer de oventemperatuur hoger in.
	Te lange baktijd.	Stel volgende keer een kortere baktijd in.
De cake wordt ongelijkmatig gebakken.	De oventemperatuur is te hoog en de baktijd te kort.	Stel volgende keer een langere baktijd en een lagere oventemperatuur in.
	Het cakebeslag is niet gelijkmatig verdeeld.	Verspreid de volgende keer het cakebeslag gelijkmatig over de bakplaat.
De cake wordt niet gaar binnen de in het recept aangegeven baktijd.	De oventemperatuur is te laag.	Stel de volgende keer de oventemperatuur iets hoger in.



9.5 Bakken op 1 rekniveau

 BAK- KEN IN BAK- VORMEN		 (°C)	 (min)	
Taartbodem - zandtaartdeeg, verwarm de oven voor	Hetelucht	170 - 180	10 - 25	2
Taartbodem - zacht cakedeeg	Hetelucht	150 - 170	20 - 25	2
Tulband / Brioche	Hetelucht	150 - 160	50 - 70	1
Zandgebak / Fruitgebak	Hetelucht	140 - 160	70 - 90	1
Kwarktaart	Boven- /onderwarmte	170 - 190	60 - 90	1

Gebruik de derde rekstand.

Gebruik de functie: Hetelucht.





Gebruik een bakplaat.

 CAKE/GEBAK/BROOD	 (°C)	 (min)
Kruimeltaart, droog	150 - 160	20 - 40
Vruchtentaart (gemaakt van gistdeeg/zacht cake-deeg), gebruik een diepe pan	150	35 - 55
Vruchtencake van zanddeeg	160 - 170	40 - 80





Verwarm de lege oven voor.





Gebruik de functie: Boven- /onderwarmte.

Gebruik een bakplaat.

 CAKE/ GEBAK/BROOD	 (°C)	 (min)	
Koninginnenbrood (opgerolde cake met jam)	180 - 200	10 - 20	3
Roggebrood:	eerst: 230 dan: 160 - 180	20 30 - 60	1
Beboterde amandeltaart / Suikerkoek	190 - 210	20 - 30	3
Roomsoezen / Eclairs	190 - 210	20 - 35	3
Plaatbrood / Broodkrans	170 - 190	30 - 40	3
Vruchtentaart (gemaakt van gistdeeg/zacht cake-deeg), gebruik een diepe pan	170	35 - 55	3
Plaatkoek met delicate garnering (bijvoorbeeld kwark, room, puddingvulling)	160 - 180	40 - 80	3
Christstollen	160 - 180	50 - 70	2





Gebruik de derde rekstand.

 KOEKJES EN BISCUITS		 (°C)	 (min)
Zandkoekjes	Hetelucht	150 - 160	10 - 20
Broodjes, verwarm de oven voor	Hetelucht	160	10 - 25
Koekjes gemaakt van sponsdeeg	Hetelucht	150 - 160	15 - 20

 KOEKJES EN BISCUITS		 (°C)	 (min)
Koekjes van bladerdeeg, verwarm de oven voor	Hetelucht	170 - 180	20 - 30
Koekjes gemaakt van gistdeeg	Hetelucht	150 - 160	20 - 40
Makarons	Hetelucht	100 - 120	30 - 50
Eiwitgebak/schuimgebak / Schuimgebakjes	Hetelucht	80 - 100	120 - 150
Broodjes, verwarm de oven voor	Boven- /onderwarmte	190 - 210	10 - 25

9.6 Ovenschotels en gegratineerde gerechten





Gebruik de eerste rekstand.

		 (°C)	 (min)
Stokbroden bedekt met gesmolten kaas	Hetelucht	160 - 170	15 - 30
Groentegratin, verwarm de oven voor	Turbo grill	160 - 170	15 - 30
Lasagne	Boven- /onderwarmte	180 - 200	25 - 40
Visschotels	Boven- /onderwarmte	180 - 200	30 - 60
Gevulde groente	Hetelucht	160 - 170	30 - 60
Zoete ovenschotels	Boven- /onderwarmte	180 - 200	40 - 60
Pasta gebakken	Boven- /onderwarmte	180 - 200	45 - 60

9.7 Bakken op meerdere niveaus

Gebruik de functie: Hetelucht.

Gebruik de bakplaten.

 CAKE/ GEBAK	 (°C)	 (min)	 2 posities
Roomsoezen / Eclairs, verwarm de oven voor	160 - 180	25 - 45	1 / 4
Kruimeltaart	150 - 160	30 - 45	1 / 4



KOEK- JES/CAKEJES/ GEBAK/BROOD- JES



(°C)



(min)



2 posities

3 posities

Broodjes	180	20 - 30	1 / 4	-
Zandkoekjes	150 - 160	20 - 40	1 / 4	1 / 3 / 5
Koekjes gemaakt van sponsdeeg	160 - 170	25 - 40	1 / 4	-
Koekjes van bladerdeeg, verwarm de oven voor	170 - 180	30 - 50	1 / 4	-
Koekjes gemaakt van gistdeeg	160 - 170	30 - 60	1 / 4	-
Makarons	100 - 120	40 - 80	1 / 4	-
Koekjes gemaakt van eiwit / Schuimgebakjes	80 - 100	130 - 170	1 / 4	-

9.8 Tips voor braden

Gebruik hittebestendig kookgerei.

Geroosterd mager vlees bedekt (u kunt aluminiumfolie gebruiken).

Braad grote vleesstukken direct in de diepe bakplaat of op een bakrooster boven de bakplaat.

Doe wat water in de bakplaat om te voorkomen dat druipend vet verbrandt.

Draai het braadstuk na 1/2 - 2/3 van de gaartijd.

Rooster vlees en vis in grote stukken (1 kg of meer).

Bedruip vleesstukken meerdere malen met hun eigen sap tijdens het roosteren.

9.9 Braden

Gebruik de eerste rekstand.



RUNDVLEES



(°C)



(min)

Stoofvlees	1 - 1,5 kg	Boven- /onder- warmte	230	120 - 150
Rosbief of ossenhaas, rood, verwarm de oven voor	per cm dikte	Turbo grill	190 - 200	5 - 6
Rosbief of ossenhaas, medium, verwarm de oven voor	per cm dikte	Turbo grill	180 - 190	6 - 8



RUNDOVLEES



(°C)



(min)

Rosbief of ossenhaas,
gaar, verwarm de oven
voor

per cm dikte

Turbo grill

170 - 180

8 - 10



VARKENSVLEES



Gebruik de functie: Turbo grill.



(kg)



(°C)



(min)

Schouder / Nek / Hamlap

1 - 1,5

160 - 180

90 - 120

Karbonade / Spare ribs

1 - 1,5

170 - 180

60 - 90

Gehaktbrood

0,75 - 1

160 - 170

50 - 60

Varkensschenkel, voorgekookt

0,75 - 1

150 - 170

90 - 120



KALFSVLEES



Gebruik de functie: Turbo grill.



(kg)



(°C)



(min)

Geroosterd kalfsvlees

1

160 - 180

90 - 120

Kalfsschenkel

1,5 - 2

160 - 180

120 - 150



LAMSVLEES



Gebruik de functie: Turbo grill.



(kg)



(°C)



(min)

Lamsbout / Geroosterd
lamsvlees

1 - 1,5

150 - 170

100 - 120

Lamsrugfilet

1 - 1,5

160 - 180

40 - 60



WILD



Gebruik de functie: Boven- /onderwarmte.



(kg)



(°C)



(min)

Rug / Hazenpoot, verwarm
de oven voor tot 1

230

30 - 40

Hert rugfilet

1,5 - 2

210 - 220

35 - 40

Reebout, hertenbout

1,5 - 2

180 - 200

60 - 90



GEVOGELTE



Gebruik de functie: Turbo grill.



(kg)



(°C)



(min)

Gevogelte, porties

0,2 - 0,25 elk

200 - 220

30 - 50

Halve kip

0,4 - 0,5 elk

190 - 210

35 - 50

Kip, haantje

1 - 1,5

190 - 210

50 - 70

Eend

1,5 - 2

180 - 200

80 - 100

Gans

3,5 - 5

160 - 180

120 - 180

Kalkoen

2,5 - 3,5

160 - 180

120 - 150

Kalkoen

4 - 6

140 - 160

150 - 240



VIS (GESTOOMD)



Gebruik de functie: Boven- /onderwarmte.



(kg)



(°C)



(min)

Hele vis

1 - 1,5

210 - 220

40 - 60

9.10 Knapperig bakken met: Pizza-functie



PIZZA



Gebruik de eerste rekstand.



(°C)



(min)

Taarten 180 - 200 40 - 55

Spinazietaart 160 - 180 45 - 60

Quiche Lorraine / Zwitserse flan 170 - 190 45 - 55

Kwarktaart 140 - 160 60 - 90

Groentetaart 160 - 180 50 - 60



PIZZA



Warm de lege oven voor het koken voor.



Gebruik de tweede rekstand.



(°C)



(min)

Pizza, dunne korst, gebruik een diepe pan 200 - 230 15 - 20

Pizza, dikke korst 180 - 200 20 - 30

Ongedesemd brood 230 - 250 10 - 20

Bladerdeegtaart 160 - 180 45 - 55

Flammkuchen 230 - 250 12 - 20

Pierogi 180 - 200 15 - 25

9.11 Grill

Warm de lege oven voor het koken voor.

Alleen dunne stukken vlees of vis grillen.

Plaats een pan op de eerste rekstand om vet op te vangen.



GRILLEN



Gebruik de functie: Grill



(°C)



(min)

1e kant



(min)

2e kant



	(°C)	(min) 1e kant	(min) 2e kant	
Rosbief	210 - 230	30 - 40	30 - 40	2
Runderfilet	230	20 - 30	20 - 30	3
Varkenshaas	210 - 230	30 - 40	30 - 40	2
Kalfsvlees	210 - 230	30 - 40	30 - 40	2
Lamsrugfilet	210 - 230	25 - 35	20 - 25	3
Hele vis, 0,5 kg - 1 kg	210 - 230	15 - 30	15 - 30	3 / 4

9.12 Bevroren gerechten



ONTDOOIEN



Gebruik de functie: Hetelucht.



(°C)



(min)



	(°C)	(min)	
Pizza, bevroren	200 - 220	15 - 25	2
American pizza, bevroren	190 - 210	20 - 25	2
Pizza, gekoeld	210 - 230	13 - 25	2
Pizzasnacks, bevroren	180 - 200	15 - 30	2
Frietjes, dun	200 - 220	20 - 30	3
Frietjes, dik	200 - 220	25 - 35	3
Aardappelschijfjes / Krokettjes	220 - 230	20 - 35	3
Rösties	210 - 230	20 - 30	3
Lasagne / Cannelloni, vers	170 - 190	35 - 45	2
Lasagne / Cannelloni, bevroren	160 - 180	40 - 60	2
Gebakken kaas	170 - 190	20 - 30	3
Vleugels van kippen	190 - 210	20 - 30	2

9.13 Ontdooien





Haal het gerecht uit de verpakking en plaats het op een bord.

Dek het voedsel niet af, want dat kan de ontdooitijd verlengen.

Plaats voor grote porties voedsel een omgedraaid bord op de bodem van de

Gebruik het eerste ovenniveau.

ovenruimte. Leg het voedsel op een diepe schaal en zet deze bovenop het bord in de oven. Verwijder indien nodig de bakplaatsteunen.

	 (kg)	 (min) Ontdooitijd	 (min) Verdere ontdooitijd	
Kip	1	100 - 140	20 - 30	Halverwege de bereidingstijd omdraaien.
Vlees	1	100 - 140	20 - 30	Halverwege de bereidingstijd omdraaien.
Forel	0,15	25 - 35	10 - 15	-
Aardbeien	0,3	30 - 40	10 - 20	-
Boter	0,25	30 - 40	10 - 15	-
Room	2 x 0,2	80 - 100	10 - 15	Klop de nog licht bevroren slagroom.
Taart	1,4	60	60	-

9.14 Inmaken

Gebruik de functie Onderwarmte.

Gebruik alleen weckpotten van dezelfde afmetingen.

Gebruik geen weckpotten met een draai- of bajonetsluiting en metalen bakken.

Gebruik de eerste rekstand.

Zet niet meer dan zes weckflessen van 1 liter op het bakrooster.

Vul de glazen potten gelijkmatig en sluit ze af met een klem.



De potten mogen elkaar niet aanraken.



Doe ongeveer 1/2 liter water in de bakplaat om voldoende vocht in de oven te geven.



Als de vloeistof in de weckpotten begint te borrelen (na ca. 35 - 60 minuten bij weckpotten van 1 liter), stop de oven of

verlaag de temperatuur tot 100 °C (raadpleeg de tabel).

Stel de temperatuur in op 160 - 170 °C.

 ZACHTE VRUCHTEN	 (min) Kooktijd tot het sudderen begint
Aardbeien / Bosbessen / Frambozen / rijpe kruisbessen	35 - 45

 STEEN- VRUCHTEN	 (min) Kooktijd tot het sudderen begint	 (min) Door blijven koken op 100 °C
Perziken / Kwee- peren / Pruimen	35 - 45	10 - 15

 GROENTEN	 (min) Kooktijd tot het sudde- ren begint	 (min) Door blijven koken op 100 °C
Wortelen	50 - 60	5 - 10
Komkommers	50 - 60	-
Gemengde au- gurken	50 - 60	5 - 10
Koolrabi / Erw- ten / Asperge	50 - 60	15 - 20

9.15 Dehydrateren - Hetelucht

Bedek de bakplaten met vetbestendig papier of bakpapier.

Voor een beter resultaat, stop de oven halverwege de droogtijd, open de deur en

9.16 Warmelucht (vochtig) - aanbevolen accessoires

Gebruik de donkere en niet-reflecterende bakjes en schalen. Ze nemen de warmte beter op dan licht en reflecterend servies.



Pizza pan

Donker, niet-reflecterend
Diameter van 28 cm



Ovenschotel

Donker, niet-reflecterend
Diameter van 26 cm



Ovenschaaltjes

Keramik
8 cm diameter, 5
cm hoog





Blik voor flanbodem

Donker, niet-reflecterend
Diameter van 28 cm



laat het een nacht afkoelen om het drogen af te ronden.

Gebruik de derde rekstand voor 1 bakplaat.

Gebruik de eerste en de vierde rekstand voor 2 bakplaten.





 GROENTEN	 (°C)	 (u)
Bonen	60 - 70	6 - 8
Paprika's	60 - 70	5 - 6
Soepgroenten	60 - 70	5 - 6
Champignons	50 - 60	6 - 8
Kruiden	40 - 50	2 - 3

Stel de temperatuur in op 60 - 70 °C.

 FRUIT	 (u)
Pruimen	8 - 10
Abrikozen	8 - 10
Schijfjes appel	6 - 8
Peren	6 - 9

9.17 Warmelucht (vochtig)

Volg voor de beste resultaten de volgende aanwijzingen op die hieronder in de tabel staan.

		 (°C)		 (min)
Zoete broodjes, 16 stuks	bakplaat of lekschaal	190	3	45 - 55
Pizza, bevroren, 0,35 kg	rooster	190	2	45 - 50
Koninginnenbrood (opgerolde cake met jam)	bakplaat of lekschaal	180	2	45 - 55
Brownie	bakplaat of lekschaal	180	2	55 - 60
Luchtige vlaaibodem	flanvorm op rooster	180	2	40 - 50
Gepocheerde vis, 0,3 kg	bakplaat of lekschaal	180	3	25 - 35
Hele vis, 0,2 kg	bakplaat of lekschaal	180	3	25 - 35
Visfilet, 0,3 kg	pizzavorm op rooster	180	3	40 - 50
Gepocheerd vlees, 0,25 kg	bakplaat of lekschaal	190	3	40 - 50
Sjasliëk, 0,5 kg	bakplaat of lekschaal	190	3	35 - 45
Koekjes, 16 stuks	bakplaat of lekschaal	160	2	40 - 50
Makarons, 24 stuks	bakplaat of lekschaal	150	2	35 - 45
Muffins, 12 stuks	bakplaat of lekschaal	160	2	35 - 45
Hartig gebak, 20 stuks	bakplaat of lekschaal	170	2	35 - 45
Zandkoekjes, 20 stuks	bakplaat of lekschaal	150	2	40 - 45
Taartjes, 8 stuks	bakplaat of lekschaal	170	2	35 - 45
Groenten, gepocheerd, 0,4 kg	bakplaat of lekschaal	180	3	45 - 55
Vegetarisch omelet	pizzavorm op rooster	190	3	40 - 50

9.18 Aanwijzingen voor testinstituten

Testen in overeenstemming met: EN 60350, IEC 60350.



BAKKEN OP ÉÉN NIVEAU. Bakken in een bakblik



(°C)



(min)



		(°C)	(min)	
Biscuittaart zonder vet	Hetelucht	140 - 150	35 - 50	2
Biscuittaart zonder vet	Boven- /onderwarmte	160	35 - 50	2
Appeltaart, 2 blikken Ø20 cm	Hetelucht	160	60 - 90	2
Appeltaart, 2 blikken Ø20 cm	Boven- /onderwarmte	180	70 - 90	1



BAKKEN OP ÉÉN NIVEAU. Koekjes



Gebruik de derde rekstand.



(°C)



(min)

		(°C)	(min)	
Zandtaartdeeg / Deegreepjes voor op vlaaien/taarten	Hetelucht	140	25 - 40	
Zandtaartdeeg / Deegreepjes voor op vlaaien/taarten, verwarm de oven voor	Boven- /onderwarmte	160	20 - 30	
Kleine cakes, 20 stuks per bakplaat, verwarm de oven voor	Hetelucht	150	20 - 35	
Kleine cakes, 20 stuks per bakplaat, verwarm de oven voor	Boven- /onderwarmte	170	20 - 30	



BAKKEN OP MEERDERE NIVEAUS. Koekjes



(°C)



(min)



		(°C)	(min)	
Zandtaartdeeg / Deegreepjes voor op vlaaien/taarten	Hetelucht	140	25 - 45	1 / 4
Kleine cakes, 20 stuks per bakplaat, verwarm de oven voor	Hetelucht	150	23 - 40	1 / 4
Biscuittaart zonder vet	Hetelucht	160	35 - 50	1 / 4



GRILLEN



Verwarm de lege oven 5 minuten voor.



Grill met de maximale temperatuurinstelling.



(min)



Geroosterd brood	Grill	1 - 3	5
Biefstuk, halverwege de bereidings- tijd omdraaien	Grill	24 - 30	4

10. ONDERHOUD EN REINIGING



WAARSCHUWING!

Raadpleeg de hoofdstukken
Veiligheid.

10.1 Opmerkingen over schoonmaken



Reinigingsmid-
delen

Maak de voorkant van de oven schoon met een zachte doek, warm water en een mild reinigingsmiddel.

Gebruik een reinigungsoplossing om metalen oppervlakken te reinigen.

Reinig vlekken met een mild reinigungsmiddel.



Dagelijks gebruik

Reinig de uitsparing telkens na gebruik. Vetophoping of andere resten kunnen brand veroorzaken.

Bewaar het voedsel niet langer dan 20 minuten in de oven. Droog de uitsparing na elk gebruik met een zachte doek.



Accessoires

Reinig alle accessoires na elk gebruik en laat ze drogen. Gebruik een zachte doek met warm water en een mild reinigungsmiddel. De accessoires niet in de afwasmachine reinigen.

Reinig de antiaanbakaccessoires niet met agressieve reinigungsmiddelen of scherpe voorwerpen.

10.2 Hoe te verwijderen: Inschuifrails/

Verwijder de inschuifrails om de oven te reinigen.

Stap 1 Schakel de oven uit en wacht tot deze afgekoeld is.

Stap 2 Trek de inschuifrail bij de voorkant uit de zijwand.

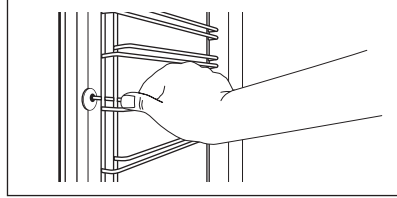

Stap 3 Trek de inschuifrail bij de achterkant uit de zijwand en verwijder deze.

Stap 4 Installeer de inschuifrails in de omgekeerde volgorde.

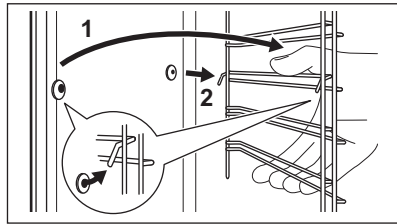

10.3 Hoe te verwijderen: Grill



WAARSCHUWING!
Gevaar voor brandwonden.

Stap 1 Zet de oven uit en wacht tot de oven afgekoeld is om deze schoon te maken. Verwijder de inschuifrails.

Stap 2 Pak de grillhoeken vast. Trek de grill naar voren tegen de veerdruk in en uit de twee houders. De grill klappt naar beneden.

Stap 3 Reinig het plafond van de oven met warm water, een zachte doek en een mild reinigingsmiddel. Laat de oven drogen.

Stap 4 Installeer de grill in de omgekeerde volgorde.

Stap 5 Installeer de inschuifrails.

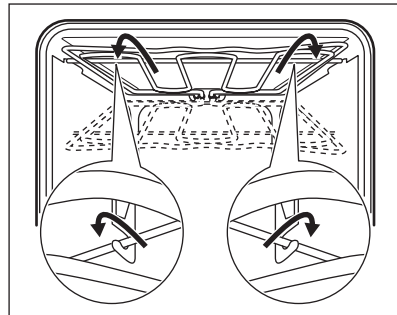

10.4 Verwijderen en installeren: Deur

U kunt de deur en de binnenste glasplaten verwijderen om ze te reinigen. U Het aantal glasplaten verschilt per model.



WAARSCHUWING!

De deur is zwaar.



LET OP!

Behandel het glas voorzichtig, vooral rond de randen van het voorpaneel. Het glas kan breken.

Stap 1 Open de deur volledig.

Stap 2 Hef en druk de klemhendels (A) op de twee deurscharnieren.

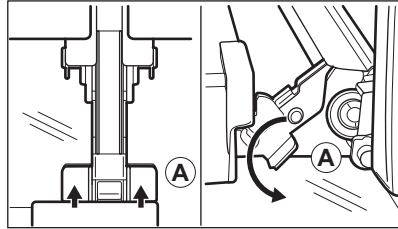

Stap 3 Sluit de ovendeur in de eerste openingsstand (in een hoek van ongeveer 70°). Houd de deur aan beide kanten vast en trek deze onder een opwaartse hoek weg van de oven. Plaats de ovendeur met de buitenkant omlaag op een zachte doek op een stabiele ondergrond.

Stap 4 Pak de deurafdekking (B) aan de bovenkant van de deur aan beide kanten vast en trek deze naar binnen om de klemsluiting te ontgrenzen.

Stap 5 Trek de deurlijst naar voren om hem te verwijderen.

Stap 6 Houd de glasplaten aan hun bovenkant vast en trek deze een voor een omhoog uit de geleider.

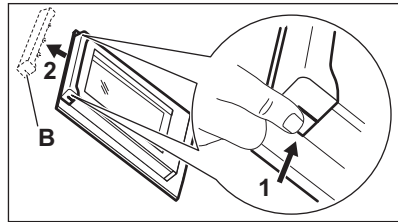

Stap 7 Reinig de glasplaat met een sopje. Droog de glasplaat voorzichtig af. Reinig de glasplaten niet in de vaatwasser.

Stap 8 Voer na het reinigen de bovenstaande stappen in de omgekeerde volgorde uit.

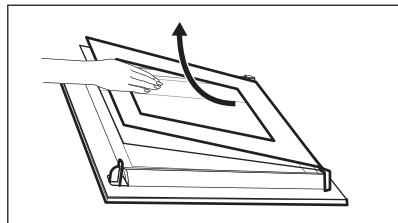

Stap 9 Plaats de kleinste glasplaat eerst, daarna de grotere glasplaat en de deur. Zorg ervoor dat de glasplaten op de juiste manier worden geplaatst, anders kan het oppervlak van de deur oververhit raken.

10.5 Hoe te vervangen: Lamp



WAARSCHUWING!

Gevaar voor elektrische schokken.
Het lampje kan heet zijn.

Voordat u de lamp vervangt:

Stap 1	Stap 2	Stap 3
Schakel de oven uit. Wacht tot de oven afgekoeld is.	Trek de oven uit het stopcontact.	Plaats een doek op de bodem van de holte.

Bovenlamp

Stap 1 Draai de glazen afdekking om die te verwijderen.

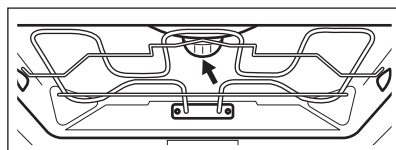

Stap 2 Reinig het glazen deksel.

Stap 3 Vervang de lamp door een geschikte hittebestendige lamp van 300 °C.

Stap 4 Installeer het glazen deksel.

11. PROBLEEMOPLOSSING



WAARSCHUWING!

Raadpleeg de hoofdstukken Veiligheid.

11.1 Wat te doen in de volgende gevallen...

Neem in alle gevallen die niet in deze tabel zijn opgenomen contact op met een erkend servicecentrum.

Probleem	Controleer of de volgende zaken gelden...
De oven wordt niet warm.	De zekering is doorgeslagen.

Probleem	Controleer of de volgende zaken gelden...
De lamp werkt niet.	De lamp is opgebrand.

11.2 Onderhoudsgegevens

Als u niet zelf het probleem kunt verhelpen, neem dan contact op met uw verkoper of een erkende serviceafdeling.

De contactgegevens van het servicecentrum staan op het typeplaatje. Het typeplaatje bevindt zich aan de voorkant van de binnenkant van de oven. Verwijder het typeplaatje niet uit de ovenruimte.

Wij adviseren u om de gegevens hier te noteren:

Model (MOD.)
Productnummer (PNC)
Serienummer (S.N.)

12. ENERGIEZUINIGHEID

12.1 Productinformatie- en productinformatieblad*

Naam leverancier	AEG
Modelidentificatie	EEB230010M 940321361
Energie-efficiëntie-index	95.3
Energie-efficiëntieklasse	A
Energieverbruik bij een standaardbelasting, stand boven + onder-warmte	0.99 kWh/cyclus
Energieverbruik bij een standaardbelasting, stand hetelucht	0.81 kWh/cyclus
Aantal ruimten	1
Warmtebron	Elektriciteit
Volume	71 l
Soort oven	Onderbouwoven
Massa	31.5 kg

* Voor de Europese Unie overeenkomstig EU-verordeningen 65/2014 en 66/2014.
Voor de Republiek Belarus overeenkomstig STB 2478-2017, aanhangsel G; STB 2477-2017, bijlagen A en B.
Voor Oekraïne overeenkomstig 568/32020.

De energie-efficiëntieklasse is niet van toepassing op Rusland.

EN 60350-1 - Elektrische huishoudelijke kookapparaten - Deel 1: Range-ovens, ovens, stoomovens en grills - Methoden voor prestatiemeting.

12.2 Energiebesparing



Deze oven bevat functies die u helpen energie te besparen tijdens het dagelijks koken.

Zorg ervoor dat de ovendeur gesloten is als u de oven in werking stelt. Open de ovendeur niet te vaak tijdens gebruik. Houd het deurrubber schoon en zorg ervoor dat het goed op zijn plaats vastzit.

Gebruik metalen kookgerei om meer energie te besparen.

Verwarm de oven niet voor als het niet hoeft.

Houd onderbrekingen tussen het bakken zo kort mogelijk als je een aantal gerechten tegelijkertijd bereidt.

Koken met hete lucht

Gebruik indien mogelijk de bereidingsfuncties met hete lucht om energie te besparen.

Restwarmte

Wanneer de kookduur langer is dan 30 minuten, verlaag dan de oventemperatuur tot minimaal 3-10 minuten voor het einde van het koken. De restwarmte in de oven blijft koken.

Je kunt de restwarmte gebruiken om andere maaltijden op te warmen.

Eten warm houden

Kies de laagst mogelijke temperatuurinstelling om de restwarmte te gebruiken en een maaltijd warm te houden.

Warmelucht (vochtig)

Functie is ontworpen om tijdens de bereiding energie te besparen.

13. MILIEUBESCHERMING

Recycleer de materialen met het symbool



Gooi de verpakking in een geschikte afvalcontainer om het te recyclen. Bescherm het milieu en de volksgezondheid en recycleer op een correcte manier het afval van elektrische en elektronische apparaten.

Gooi apparaten gemarkeerd met het symbool



niet weg met het huishoudelijk afval. Breng het product naar het milieustation bij u in de buurt of neem contact op met de gemeente.

FOR PERFECT RESULTS

Thank you for choosing this AEG product. We have created it to give you impeccable performance for many years, with innovative technologies that help make life simpler – features you might not find on ordinary appliances. Please spend a few minutes reading to get the very best from it.

Visit our website to:



Get usage advice, brochures, trouble shooter, service and repair information:
www.aeg.com/support



Register your product for better service:
www.registeraeg.com



Buy Accessories, Consumables and Original spare parts for your appliance:
www.aeg.com/shop

CUSTOMER CARE AND SERVICE

Always use original spare parts.

When contacting our Authorised Service Centre, ensure that you have the following data available: Model, PNC, Serial Number.

The information can be found on the rating plate.

 Warning / Caution-Safety information

 General information and tips

 Environmental information

Subject to change without notice.

CONTENTS

1. SAFETY INFORMATION.....	58
2. SAFETY INSTRUCTIONS.....	60
3. PRODUCT DESCRIPTION.....	63
4. CONTROL PANEL.....	63
5. BEFORE FIRST USE.....	64
6. DAILY USE.....	64
7. USING THE ACCESSORIES.....	65
8. ADDITIONAL FUNCTIONS.....	66
9. HINTS AND TIPS.....	66
10. CARE AND CLEANING.....	80
11. TROUBLESHOOTING.....	83
12. ENERGY EFFICIENCY.....	83

1. SAFETY INFORMATION

Before the installation and use of the appliance, carefully read the supplied instructions. The manufacturer is not responsible

for any injuries or damage that are the result of incorrect installation or usage. Always keep the instructions in a safe and accessible location for future reference.

1.1 Children and vulnerable people safety

- This appliance can be used by children aged from 8 years and above and persons with reduced physical, sensory or mental capabilities or lack of experience and knowledge if they have been given supervision or instruction concerning the use of the appliance in a safe way and understand the hazards involved. Children of less than 8 years of age and persons with very extensive and complex disabilities shall be kept away from the appliance unless continuously supervised.
- Children should be supervised to ensure that they do not play with the appliance.
- Keep all packaging away from children and dispose of it appropriately.
- **WARNING:** Keep children and pets away from the appliance when it operates or when it cools down. Accessible parts become hot during use.
- If the appliance has a child safety device, it should be activated.
- Children shall not carry out cleaning and user maintenance of the appliance without supervision.

1.2 General Safety

- Only a qualified person must install this appliance and replace the cable.
- Do not use the appliance before installing it in the built-in structure.
- Disconnect the appliance from the power supply before carrying out any maintenance.
- If the mains power supply cable is damaged, it must be replaced by the manufacturer, its Authorised Service Centre or similarly qualified persons to avoid an electrical hazard.

- The control panel must be connected to specified heating unit with matching colours of connectors, to avoid possible hazard.
- The means for disconnection must be incorporated in the fixed wiring in accordance with the wiring rules.
- **WARNING:** Ensure that the appliance is switched off before replacing the lamp to avoid the possibility of electric shock.
- **WARNING:** The appliance and its accessible parts become hot during use. Care should be taken to avoid touching heating elements.
- Always use oven gloves to remove or put in accessories or ovenware.
- To remove the shelf supports first pull the front of the shelf support and then the rear end away from the side walls. Install the shelf supports in the opposite sequence.
- Do not use a steam cleaner to clean the appliance.
- Do not use harsh abrasive cleaners or sharp metal scrapers to clean the glass door since they can scratch the surface, which may result in shattering of the glass.

2. SAFETY INSTRUCTIONS

2.1 Installation



WARNING!

Only a qualified person must install this appliance.

- Remove all the packaging.
- Do not install or use a damaged appliance.
- Follow the installation instructions supplied with the appliance.
- Always take care when moving the appliance as it is heavy. Always use safety gloves and enclosed footwear.
- Do not pull the appliance by the handle.
- Install the appliance in a safe and suitable place that meets installation requirements.
- The kitchen cabinet and the recess must have suitable dimensions.
- Keep the minimum distance from other appliances and units.

- Before mounting the appliance, check if the oven door opens without restraint.
- Parts of the appliance carry current. Close the appliance with furniture to prevent touching the dangerous parts.
- The appliance is equipped with an electric cooling system. It must be operated with the electric power supply.
- The built-in unit must meet the stability requirements of DIN 68930.

Cabinet minimum height (Cabinet under the worktop minimum height)	578 (600) mm
---	--------------

Cabinet width	560 mm
---------------	--------

Cabinet depth	550 (550) mm
---------------	--------------

Height of the front of the appliance	594 mm
---	--------

Height of the back of the appliance	576 mm
--	--------

Width of the front of the appliance	595 mm
Width of the back of the appliance	559 mm
Depth of the appliance	567 mm
Built in depth of the appliance	546 mm
Depth with open door	1027 mm
Ventilation opening minimum size. Opening placed on the bottom rear side	560 x 20 mm
Mounting screws	4 x 25 mm

2.2 Electrical connection



WARNING!

Risk of fire and electric shock.

- All electrical connections should be made by a qualified electrician.
- The appliance must be earthed.
- Make sure that the parameters on the rating plate are compatible with the electrical ratings of the mains power supply.
- Always use a correctly installed shockproof socket.
- Do not use multi-plug adapters and extension cables.
- Make sure not to cause damage to the mains plug and to the mains cable. Should the mains cable need to be replaced, this must be carried out by our Authorised Service Centre.
- Do not let mains cables touch or come near the appliance door or the niche below the appliance, especially when it operates or the door is hot.
- The shock protection of live and insulated parts must be fastened in such a way that it cannot be removed without tools.
- Connect the mains plug to the mains socket only at the end of the installation. Make sure that there is access to the mains plug after the installation.
- If the mains socket is loose, do not connect the mains plug.
- Do not pull the mains cable to disconnect the appliance. Always pull the mains plug.

- Use only correct isolation devices: line protecting cut-outs, fuses (screw type fuses removed from the holder), earth leakage trips and contactors.
- The electrical installation must have an isolation device which lets you disconnect the appliance from the mains at all poles. The isolation device must have a contact opening width of minimum 3 mm.
- This appliance is supplied without a main plug and a main cable.

2.3 Use



WARNING!

Risk of injury, burns and electric shock or explosion.

- This appliance is for household (indoors) use only.
- Do not change the specification of this appliance.
- Make sure that the ventilation openings are not blocked.
- Do not let the appliance stay unattended during operation.
- Deactivate the appliance after each use.
- Be careful when you open the appliance door while the appliance is in operation. Hot air can release.
- Do not operate the appliance with wet hands or when it has contact with water.
- Do not apply pressure on the open door.
- Do not use the appliance as a work surface or as a storage surface.
- Open the appliance door carefully. The use of ingredients with alcohol can cause a mixture of alcohol and air.
- Do not let sparks or open flames to come in contact with the appliance when you open the door.
- Do not put flammable products or items that are wet with flammable products in, near or on the appliance.



WARNING!

Risk of damage to the appliance.

- To prevent damage or discoloration to the enamel:
 - do not put ovenware or other objects in the appliance directly on the bottom.
 - do not put aluminium foil directly on the bottom of cavity of the appliance.

- do not put water directly into the hot appliance.
- do not keep moist dishes and food in the appliance after you finish the cooking.
- be careful when you remove or install the accessories.
- Discoloration of the enamel or stainless steel has no effect on the performance of the appliance.
- Use a deep pan for moist cakes. Fruit juices cause stains that can be permanent.
- This appliance is for cooking purposes only. It must not be used for other purposes, for example room heating.
- Always cook with the oven door closed.

2.4 Care and cleaning



WARNING!

Risk of injury, fire, or damage to the appliance.

- Before maintenance, deactivate the appliance and disconnect the mains plug from the mains socket.
- Make sure the appliance is cold. There is the risk that the glass panels can break.
- Replace immediately the door glass panels when they are damaged. Contact the Authorised Service Centre.
- Be careful when you remove the door from the appliance. The door is heavy!
- Clean regularly the appliance to prevent the deterioration of the surface material.
- Clean the appliance with a moist soft cloth. Use only neutral detergents. Do not use abrasive products, abrasive cleaning pads, solvents or metal objects.
- If you use an oven spray, follow the safety instructions on its packaging.

2.5 Internal lighting



WARNING!

Risk of electric shock.

- Concerning the lamp(s) inside this product and spare part lamps sold separately: These lamps are intended to withstand extreme physical conditions in household appliances, such as temperature, vibration, humidity, or are intended to signal information about the operational status of the appliance. They are not intended to be used in other applications and are not suitable for household room illumination.
- Use only lamps with the same specifications.

2.6 Service

- To repair the appliance contact the Authorised Service Centre.
- Use original spare parts only.

2.7 Disposal



WARNING!

Risk of injury or suffocation.

- Contact your municipal authority for information on how to dispose of the appliance.
- Disconnect the appliance from the mains supply.
- Cut off the mains electrical cable close to the appliance and dispose of it.
- Remove the door catch to prevent children or pets from becoming trapped in the appliance.

3. PRODUCT DESCRIPTION

3.1 General overview

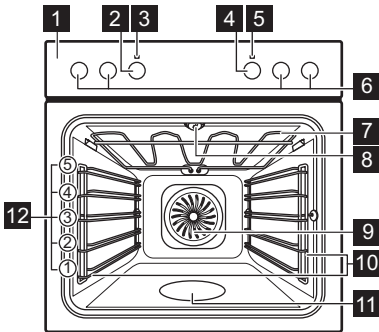

- 1** Control panel
- 2** Knob for the heating functions
- 3** Power lamp / symbol
- 4** Control knob (for the temperature)
- 5** Temperature indicator / symbol
- 6** Knobs for the cooking zones
- 7** Heating element
- 8** Lamp
- 9** Fan
- 10** Shelf support, removable
- 11** Cavity embossment
- 12** Shelf positions

3.2 Accessories

Wire shelf

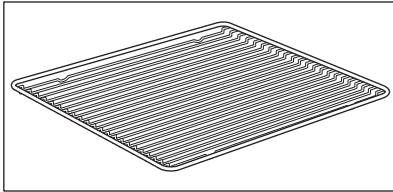

For cookware, cake tins, roasts.

Combi pan

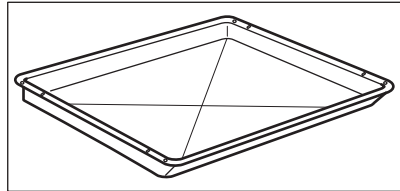

For cakes and biscuits. To bake and roast or as a pan to collect fat.

4. CONTROL PANEL

4.1 Knobs for the cooking zones

You can operate the hob with the knobs for the cooking zones.



You must read the Safety chapters in the hob user manual.

4.2 Heat settings

Knob indication	Function
0	Off position
	Keep warm setting

Knob indication	Function
1 - 9	Heat settings

1. Turn the knob to a necessary heat setting.

- To complete the cooking process, turn the knob to the off position.

4.3 Automatic heat-up

-  Only applicable for hobs with the automatic heat-up function.

The automatic heat-up function heats the cooking zone with full power for some time.

- Turn the knob for the cooking zone clockwise as far as possible (beyond the highest heat setting).
- Immediately set the necessary heat setting.

- To deactivate the function, turn the knob to the off position.

4.4 Using the double zone (if applicable)

-  To activate the double zone, turn the knob clockwise. Do not turn it through the stop position.

- Turn the knob clockwise to position 9.
- Turn the knob slowly until you can hear a click. The two cooking zones are on.
- To set the necessary heat setting refer to "Heat settings".

5. BEFORE FIRST USE



WARNING!

Refer to Safety chapters.

5.1 Before first use

The oven can emit an odour and smoke during preheating. Make sure that the room is ventilated.



Step 1



Clean the oven

- Remove all accessories and removable shelf supports from the oven.
- Clean the oven and the accessories with a soft cloth, warm water and a mild detergent.



Step 2

Preheat the empty oven

- Set the maximum temperature for the function: . Time: 1 h.
- Set the maximum temperature for the function: . Time: 15 min.

Turn off the oven and wait until it is cold. Place the accessories and the removable shelf supports in the oven.

6. DAILY USE



WARNING!

Refer to Safety chapters.









6.1 How to set: Heating function



- Step 1** Turn the knob for the heating functions to select a heating function.

- Step 2** Turn the control knob to select the temperature.

- Step 3** When the cooking ends, turn the knobs to the off position to turn off the oven.

6.2 Heating functions

Heating function	Application
 Off position	The oven is off.
 Light	To turn on the lamp.
 True Fan Cooking	To bake on up to three shelf positions at the same time and to dry food. Set the temperature 20 - 40 °C lower than for Conventional Cooking.
 Pizza Function	To bake pizza. To make intensive browning and a crispy bottom.
 Conventional Cooking	To bake and roast food on one shelf position.
 Bottom Heat	To bake cakes with crispy bottom and to preserve food.
 Defrost	To defrost food (vegetables and fruit). The defrosting time depends on the amount and size of the frozen food.
 Moist Fan Baking	This function is designed to save energy during cooking. When you use this function, the temperature in the cavity may differ from the set temperature. The heating power may be reduced. For more information refer to "Daily Use" chapter, Notes on: Moist Fan Baking.

Heating function	Application
 Grill	To grill thin pieces of food and to toast bread.
 Turbo Grilling	To roast large meat joints or poultry with bones on one shelf position. To make gratins and to brown.

 The lamp may turn off automatically at a temperature below 60 °C during some oven functions.

6.3 Notes on: Moist Fan Baking

This function was used to comply with the energy efficiency class and ecodesign requirements according to EU 65/2014 and EU 66/2014. Tests according to EN 60350-1.

The oven door should be closed during cooking so that the function is not interrupted and the oven operates with the highest energy efficiency possible.

For the cooking instructions refer to "Hints and tips" chapter, Moist Fan Baking. For general energy saving recommendations refer to "Energy Efficiency" chapter, Energy Saving.

7. USING THE ACCESSORIES



WARNING!
Refer to Safety chapters.

7.1 Inserting accessories

A small indentation at the top increases safety. The indentations are also anti-tip devices. The high rim around the shelf prevents cookware from slipping of the shelf.

Wire shelf:

Push the shelf between the guide bars of the shelf support.

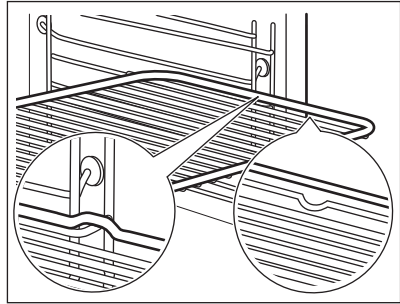

Deep pan:

Push the tray between the guide bars of the shelf support.

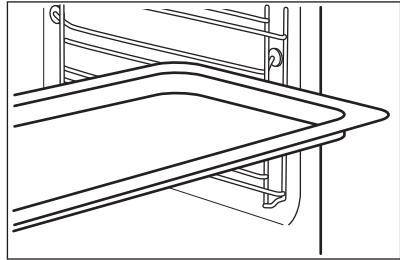

Wire shelf, Deep pan:

Push the tray between the guide bars of the shelf support and the wire shelf on the guide bars above.

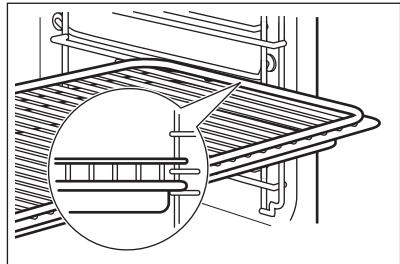

8. ADDITIONAL FUNCTIONS

8.1 Cooling fan

When the oven operates, the cooling fan turns on automatically to keep the surfaces of

the oven cool. If you turn off the oven, the cooling fan can continue to operate until the oven cools down.

9. HINTS AND TIPS



Refer to Safety chapters.

9.1 Examples of cooking applications for the hob

Heat setting	Application	Time (min)	Hints
1	To keep cooked food warm.	as required	Put a lid on the cookware.
1 - 2	To make Hollandaise sauce, and to melt butter, chocolate and gelatine.	5 - 25	Mix at intervals.
1 - 2	To solidify fluffy omelettes and baked eggs.	10 - 40	Cook with a lid on.
2 - 3	To simmer rice and milk-based dishes, and to heat up ready-cooked meals.	25 - 50	Add a minimum of two times as much liquid as rice. Stir milk dishes halfway through.
3 - 4	To steam vegetables, fish and meat.	20 - 45	Add some tablespoons of a liquid.
4 - 5	To steam potatoes.	20 - 60	Use a maximum of 1/4 l water for 750 g of potatoes.
4 - 5	To cook larger quantities of food, stews and soups.	60 - 150	Add a maximum of 3 l of a liquid to the ingredients.
6 - 7	To lightly fry escalopes, veal cordon bleu, cutlets, rissoles, sausages, liver, eggs, pancakes and doughnuts, and to cook roux.	as required	Turn halfway through.
7 - 8	To fry hash browns, loin steaks and steaks.	5 - 15	Turn halfway through.
9	To boil large quantities of water, to cook pasta, to sear meat (goulash, pot roast) and to deep-fry chips.		

9.2 Cooking recommendations



The temperature and cooking times in the tables are guidelines only. They depend on the recipes and the quality and quantity of the ingredients used.

Your oven may bake or roast differently to the oven you had before. The tables below show recommended settings for temperature, cooking time and shelf position for specific types of the food.

If you cannot find the settings for a special recipe, look for the similar one.

9.3 Baking

For the first baking, use the lower temperature.

You can extend the baking time by 10 – 15 minutes if you bake cakes on more than one shelf position.

Cakes and pastries at different heights do not always brown equally. There is no need to





change the temperature setting if an unequal browning occurs. The differences equalize during baking.

Trays in the oven can distort during baking. When the trays are cold again, the distortions disappear.

9.4 Tips on baking

Baking results	Possible cause	Remedy
The bottom of the cake is not baked sufficiently.	The shelf position is incorrect.	Put the cake on a lower shelf.
The cake sinks and becomes soggy or streaky.	The oven temperature is too high.	Next time set slightly lower oven temperature.
	The oven temperature is too high and the baking time is too short.	Next time set a longer baking time and lower oven temperature.
The cake is too dry.	The oven temperature is too low.	Next time set higher oven temperature.
	The baking time is too long.	Next time set shorter baking time.
The cake bakes unevenly.	The oven temperature is too high and the baking time is too short.	Next time set a longer baking time and lower oven temperature.
	The cake batter is not evenly distributed.	Next time spread the cake batter evenly on the baking tray.
The cake is not ready in the baking time specified in a recipe.	The oven temperature is too low.	Next time set a slightly higher oven temperature.



9.5 Baking on one shelf level

 BAKING IN TINS		 (°C)	 (min)	
Flan base - short pastry, preheat the empty oven	True Fan Cooking	170 - 180	10 - 25	2
Flan base - sponge cake mixture	True Fan Cooking	150 - 170	20 - 25	2
Ring cake / Brioche	True Fan Cooking	150 - 160	50 - 70	1
Madeira cake / Fruit cakes	True Fan Cooking	140 - 160	70 - 90	1
Cheesecake	Conventional Cooking	170 - 190	60 - 90	1

Use the third shelf position.

Use the function: True Fan Cooking.

Use a baking tray.

 CAKES / PASTRIES / BREADS	 (°C)	 (min)
Cake with crumble topping	150 - 160	20 - 40

**CAKES / PASTRIES / BREADS****(°C)****(min)**

Fruit flans (made of yeast dough / sponge cake mixture), use a deep pan

150

35 - 55

Fruit flans made of short pastry

160 - 170

40 - 80

Preheat the empty oven.

Use the function: Conventional Cooking.

Use a baking tray.

**CAKES / PASTRIES / BREADS****(°C)****(min)**

Swiss roll

180 - 200

10 - 20

3

Rye bread:

first: 230

20

1

then: 160 - 180

30 - 60

Buttered almond cake /
Sugar cakes

190 - 210

20 - 30

3

Cream puffs / Eclairs

190 - 210

20 - 35

3

Plaited bread / Bread
crown

170 - 190

30 - 40

3

Fruit flans (made of yeast
dough / sponge cake
mixture), use a deep pan

170

35 - 55

3

Yeast cakes with delicate
toppings (e.g. quark,
cream, custard)

160 - 180

40 - 80

3

Christstollen

160 - 180

50 - 70

2

Use the third shelf position.

**BISCUITS****(°C)****(min)**

Short pastry biscuits

True Fan Cooking

150 - 160

10 - 20

Rolls, preheat the empty oven

True Fan Cooking

160

10 - 25

Biscuits made of sponge cake
mixture

True Fan Cooking

150 - 160

15 - 20

Puff pastries, preheat the empty
oven

True Fan Cooking

170 - 180





20 - 30

Biscuits made of yeast dough

True Fan Cooking





150 - 160

20 - 40

 BISCUITS		 (°C)	 (min)
Macaroons	True Fan Cooking	100 - 120	30 - 50
Pastries made of egg white / Meringues	True Fan Cooking	80 - 100	120 - 150
Rolls, preheat the empty oven	Conventional Cooking	190 - 210	10 - 25

9.6 Bakes and gratins





Use the first shelf position.





		 (°C)	 (min)
Baguettes topped with mel- ted cheese	True Fan Cooking	160 - 170	15 - 30
Vegetables au gratin, pre- heat the empty oven	Turbo Grilling	160 - 170	15 - 30
Lasagne	Conventional Cooking	180 - 200	25 - 40
Fish bakes	Conventional Cooking	180 - 200	30 - 60
Stuffed vegetables	True Fan Cooking	160 - 170	30 - 60
Sweet bakes	Conventional Cooking	180 - 200	40 - 60
Pasta bake	Conventional Cooking	180 - 200	45 - 60

9.7 Multilevel Baking

Use the function: True Fan Cooking.

Use the baking trays.

 CAKES / PASTRIES	 (°C)	 (min)	 2 positions
Cream puffs / Eclairs, pre- heat the empty oven	160 - 180	25 - 45	1 / 4
Dry streusel cake	150 - 160	30 - 45	1 / 4

 BIS- CUITS / SMALL CAKES / PAS- TRIES / ROLLS	 (°C)	 (min)	 2 positions	3 positions
Rolls	180	20 - 30	1 / 4	-
Short pastry biscuits	150 - 160	20 - 40	1 / 4	1 / 3 / 5
Biscuits made of sponge cake mixture	160 - 170	25 - 40	1 / 4	-
Puff pastries, pre- heat the empty oven	170 - 180	30 - 50	1 / 4	-
Biscuits made of yeast dough	160 - 170	30 - 60	1 / 4	-
Macaroons	100 - 120	40 - 80	1 / 4	-
Biscuits made of egg white / Meringues	80 - 100	130 - 170	1 / 4	-

9.8 Tips on Roasting

Use heat-resistant ovenware.

Roast lean meat covered (you can use aluminium foil).

Roast large meat joints directly in the tray or on the wire shelf placed above the tray.

Put some water in the tray to prevent dripping fat from burning.







Turn the roast after 1/2 - 2/3 of the cooking time.

Roast meat and fish in large pieces (1 kg or more).

Baste meat joints with their own juice several times during roasting.

9.9 Roasting

Use the first shelf position.

 BEEF				 (°C)	 (min)
Pot roast	1 - 1.5 kg	Conventional Cook- ing	230	120 - 150	
Roast beef or fillet, rare, preheat the empty oven	per cm of thickness	Turbo Grilling	190 - 200	5 - 6	
Roast beef or fillet, medi- um, preheat the empty oven	per cm of thickness	Turbo Grilling	180 - 190	6 - 8	



BEEF



(°C)



(min)

Roast beef or fillet, well done, preheat the empty oven

per cm of thickness

Turbo Grilling

170 - 180

8 - 10



PORK



Use the function: Turbo Grilling.



(kg)



(°C)



(min)

Shoulder / Neck / Ham joint

1 - 1.5

160 - 180

90 - 120

Chops / Spare rib

1 - 1.5

170 - 180

60 - 90

Meatloaf

0.75 - 1

160 - 170

50 - 60

Pork knuckle, precooked

0.75 - 1

150 - 170

90 - 120



VEAL



Use the function: Turbo Grilling.



(kg)



(°C)



(min)

Roast veal

1

160 - 180

90 - 120

Veal knuckle

1.5 - 2

160 - 180

120 - 150



LAMB



Use the function: **Turbo Grilling.**



(kg)



(°C)



(min)

Lamb leg / Roast lamb	1 - 1.5	150 - 170	100 - 120
Lamb saddle	1 - 1.5	160 - 180	40 - 60



GAME



Use the function: **Conventional Cooking.**



(kg)



(°C)



(min)

Saddle / Hare leg, preheat the empty oven	up to 1	230	30 - 40
Venison saddle	1.5 - 2	210 - 220	35 - 40
Haunch of venison	1.5 - 2	180 - 200	60 - 90



POULTRY



Use the function: **Turbo Grilling.**



(kg)



(°C)



(min)

Poultry, portions	0.2 - 0.25 each	200 - 220	30 - 50
Chicken, half	0.4 - 0.5 each	190 - 210	35 - 50
Chicken, poulard	1 - 1.5	190 - 210	50 - 70
Duck	1.5 - 2	180 - 200	80 - 100
Goose	3.5 - 5	160 - 180	120 - 180
Turkey	2.5 - 3.5	160 - 180	120 - 150
Turkey	4 - 6	140 - 160	150 - 240



FISH (STEAMED)



Use the function: **Conventional Cooking.**



(kg)



(°C)



(min)

Whole fish

1 - 1.5

210 - 220

40 - 60

9.10 Crispy baking with: Pizza Function



PIZZA



Use the first shelf position.



(°C)



(min)

Tarts

180 - 200

40 - 55

Spinach flan

160 - 180

45 - 60

Quiche lorraine /
Swiss flan

170 - 190

45 - 55

Cheesecake

140 - 160

60 - 90

Vegetable pie

160 - 180

50 - 60



PIZZA



Preheat the empty oven before cooking.



Use the second shelf position.



(°C)



(min)

Pizza, thin crust,
use a deep pan

200 - 230

15 - 20



PIZZA



Preheat the empty oven before cooking.



Use the second shelf position.



(°C)



(min)

Pizza, thick
crust

180 - 200

20 - 30

Unleavened
bread

230 - 250

10 - 20

Puff pastry flan

160 - 180

45 - 55

Flammkuchen

230 - 250

12 - 20

Pierogi

180 - 200

15 - 25

9.11 Grill

Preheat the empty oven before cooking.

Grill only thin pieces of meat or fish.

Put a pan on the first shelf position to collect fat.



GRILL



Use the function: Grill



(°C)



(min)
1st side



(min)
2nd side



	(°C)	(min) 1st side	(min) 2nd side	
Roast beef	210 - 230	30 - 40	30 - 40	2
Beef fillet	230	20 - 30	20 - 30	3
Pork loin	210 - 230	30 - 40	30 - 40	2
Veal loin	210 - 230	30 - 40	30 - 40	2
Lamb saddle	210 - 230	25 - 35	20 - 25	3
Whole fish, 0.5 kg - 1 kg	210 - 230	15 - 30	15 - 30	3 / 4

9.12 Frozen Foods



DEFROSTING



Use the function: True Fan Cooking.



(°C)



(min)



	(°C)	(min)	
Pizza, frozen	200 - 220	15 - 25	2
Pizza American, frozen	190 - 210	20 - 25	2
Pizza, chilled	210 - 230	13 - 25	2
Pizza snacks, frozen	180 - 200	15 - 30	2
French fries, thin	200 - 220	20 - 30	3
French fries, thick	200 - 220	25 - 35	3
Wedges / Croquettes	220 - 230	20 - 35	3
Hash browns	210 - 230	20 - 30	3
Lasagne / Cannelloni, fresh	170 - 190	35 - 45	2
Lasagne / Cannelloni, frozen	160 - 180	40 - 60	2
Baked cheese	170 - 190	20 - 30	3
Chicken wings	190 - 210	20 - 30	2





9.13 Defrost

Remove the food packaging and put the food on a plate.

Do not cover the food, as this can extend the defrost time.

Use the first shelf position.

For large portions of food place an upturned empty plate on the bottom of the oven cavity. Put the food in a deep dish and set it on top of the plate inside the oven. Remove the shelf supports if necessary.

	 (kg)	 (min) Defrosting time	 (min) Further defrosting time	
Chicken	1	100 - 140	20 - 30	Turn halfway through.
Meat	1	100 - 140	20 - 30	Turn halfway through.
Trout	0.15	25 - 35	10 - 15	-
Strawberries	0.3	30 - 40	10 - 20	-
Butter	0.25	30 - 40	10 - 15	-
Cream	2 x 0.2	80 - 100	10 - 15	Whip the cream when still slightly frozen in places.
Gateau	1.4	60	60	-

9.14 Preserving

Use the function Bottom Heat.

Use only preserve jars of the same dimensions available on the market.

Do not use jars with twist-off and bayonet type lids or metal tins.

Use the first shelf position.

Put no more than six one-litre preserve jars on the baking tray.

Fill the jars equally and close with a clamp.

The jars cannot touch each other.



Put approximately 1/2 litre of water into the baking tray to give sufficient moisture in the oven.

When the liquid in the jars starts to simmer (after approximately 35 - 60 minutes with one-litre jars), stop the oven or decrease the temperature to 100 °C (see the table).



Set the temperature to 160 - 170 °C.

 SOFT FRUIT	 (min) Cooking time until simmering
--	--

Strawberries / Blueberries / Raspberries / Ripe gooseberries 35 - 45

 STONE FRUIT	 (min) Cooking time until simmering	 (min) Continue to cook at 100 °C
---	--	--

Peaches / Quinces / Plums 35 - 45 10 - 15

 VEG-ETABLES	 (min) Cooking time until simmering	 (min) Continue to cook at 100 °C
Carrots	50 - 60	5 - 10
Cucumbers	50 - 60	-
Mixed pickles	50 - 60	5 - 10
Kohlrabi / Peas / Asparagus	50 - 60	15 - 20

9.15 Dehydrating - True Fan Cooking

Cover trays with grease proof paper or baking parchment.

For a better result, stop the oven halfway through the drying time, open the door and let it cool down for one night to complete the drying.

For 1 tray use the third shelf position.

For 2 trays use the first and fourth shelf position.

9.16 Moist Fan Baking - recommended accessories

Use the dark and non-reflective tins and containers. They have better heat absorption than the light colour and reflective dishes.



Pizza pan

Dark, non-reflective
28 cm diameter

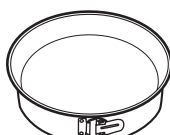

Baking dish

Dark, non-reflective
26 cm diameter



Ramekins

Ceramic
8 cm diameter, 5 cm height

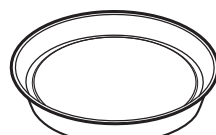



Flan base tin



Dark, non-reflective
28 cm diameter





9.17 Moist Fan Baking

For the best results follow suggestions listed in the table below.

 VEGETABLES	 (°C)	 (h)
Beans	60 - 70	6 - 8
Peppers	60 - 70	5 - 6
Vegetables for soup	60 - 70	5 - 6
Mushrooms	50 - 60	6 - 8
Herbs	40 - 50	2 - 3







Set the temperature to 60 - 70 °C.

 FRUIT	 (h)
Plums	8 - 10
Apricots	8 - 10
Apple slices	6 - 8
Pears	6 - 9

		 (°C)		 (min)
Sweet rolls, 16 pieces	baking tray or dripping pan	190	3	45 - 55
Pizza, frozen, 0.35 kg	wire shelf	190	2	45 - 50
Swiss roll	baking tray or dripping pan	180	2	45 - 55
Brownie	baking tray or dripping pan	180	2	55 - 60
Sponge flan base	flan base tin on wire shelf	180	2	40 - 50
Poached fish, 0.3 kg	baking tray or dripping pan	180	3	25 - 35
Whole fish, 0.2 kg	baking tray or dripping pan	180	3	25 - 35
Fish fillet, 0.3 kg	pizza pan on wire shelf	180	3	40 - 50
Poached meat, 0.25 kg	baking tray or dripping pan	190	3	40 - 50
Shashlik, 0.5 kg	baking tray or dripping pan	190	3	35 - 45
Cookies, 16 pieces	baking tray or dripping pan	160	2	40 - 50
Macaroons, 24 pieces	baking tray or dripping pan	150	2	35 - 45
Muffins, 12 pieces	baking tray or dripping pan	160	2	35 - 45
Savory pastry, 20 pieces	baking tray or dripping pan	170	2	35 - 45
Short crust biscuits, 20 pieces	baking tray or dripping pan	150	2	40 - 45
Tartlets, 8 pieces	baking tray or dripping pan	170	2	35 - 45
Vegetables, poached, 0.4 kg	baking tray or dripping pan	180	3	45 - 55
Vegetarian omelette	pizza pan on wire shelf	190	3	40 - 50

9.18 Information for test institutes

Tests according to: EN 60350, IEC 60350.

 BAKING ON ONE LEVEL. Baking in tins				
		 (°C)	 (min)	
Fatless sponge cake	True Fan Cooking	140 - 150	35 - 50	2
Fatless sponge cake	Conventional Cooking	160	35 - 50	2
Apple pie, 2 tins Ø20 cm	True Fan Cooking	160	60 - 90	2
Apple pie, 2 tins Ø20 cm	Conventional Cooking	180	70 - 90	1



BAKING ON ONE LEVEL. Biscuits



Use the third shelf position.



(°C)



(min)

Short bread / Pastry strips	True Fan Cooking	140	25 - 40
Short bread / Pastry strips, pre-heat the empty oven	Conventional Cooking	160	20 - 30
Small cakes, 20 per tray, preheat the empty oven	True Fan Cooking	150	20 - 35
Small cakes, 20 per tray, preheat the empty oven	Conventional Cooking	170	20 - 30



MULTILEVEL BAKING. Biscuits



(°C)



(min)



Short bread / Pastry strips	True Fan Cooking	140	25 - 45	1 / 4
Small cakes, 20 per tray, pre-heat the empty oven	True Fan Cooking	150	23 - 40	1 / 4
Fatless sponge cake	True Fan Cooking	160	35 - 50	1 / 4



GRILL



Preheat the empty oven for 5 minutes.



Grill with the maximum temperature setting.



(min)



Toast	Grill	1 - 3	5
Beef steak, turn halfway through	Grill	24 - 30	4

10. CARE AND CLEANING



WARNING!

Refer to Safety chapters.

10.1 Notes on cleaning



Clean the front of the oven with a soft cloth with warm water and a mild detergent.

Use a cleaning solution to clean metal surfaces.

Clean stains with a mild detergent.

Cleaning Agents



Clean the cavity after each use. Fat accumulation or other residue may cause fire.

Do not store the food in the oven for longer than 20 minutes. Dry the cavity with a soft cloth after each use.

Everyday Use



Clean all accessories after each use and let them dry. Use a soft cloth with warm water and a mild detergent. Do not clean the accessories in a dishwasher.

Do not clean the non-stick accessories using abrasive cleaner or sharp-edged objects.

Accessories

10.2 How to remove: Shelf supports

Remove the shelf supports to clean the oven.

Step 1 Turn off the oven and wait until it is cold.

Step 2 Pull the front of the shelf support away from the side wall.

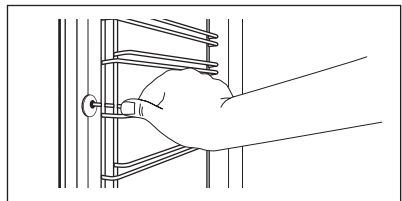

Step 3 Pull the rear end of the shelf support away from the side wall and remove it.

Step 4 Install the shelf supports in the opposite sequence.

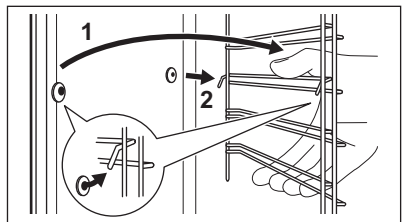

10.3 How to remove: Grill



WARNING!

There is a risk of burns.

Step 1 Turn off the oven and wait until it is cold to clean it.
Remove the shelf supports.

Step 2 Grab the grill corners. Pull it forwards against the spring pressure and out of two holders. The grill folds down.

Step 3 Clean the oven ceiling with warm water, a soft cloth and a mild detergent. Let it dry.

Step 4 Install the grill in the opposite sequence.

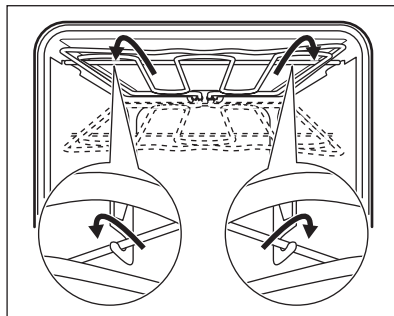

Step 5 Install the shelf supports.

10.4 How to remove and install: Door

You can remove the door and the internal glass panels to clean it. The number of glass panels is different for different models.



WARNING!

The door is heavy.

Step 1 Fully open the door.

Step 2 Lift and press the clamping levers (A) on the two door hinges.



CAUTION!

Carefully handle the glass, especially around the edges of the front panel. The glass can break.

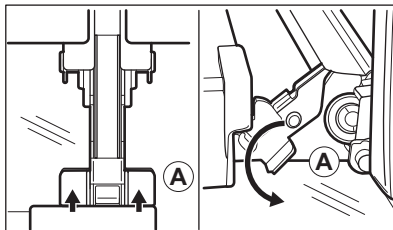

Step 3 Close the oven door to the first opening position (approximately 70° angle). Hold the door at both sides and pull it away from the oven at an upwards angle. Put the door with the outer side down on a soft cloth on a stable surface.

Step 4 Hold the door trim (B) on the top edge of the door at the two sides and push inwards to release the clip seal.

Step 5 Pull the door trim to the front to remove it.

Step 6 Hold the door glass panels on their top edge one by one and pull them up out of the guide.

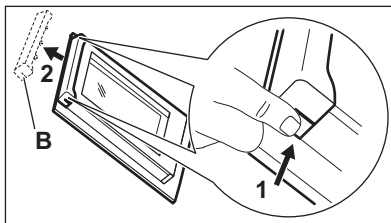

Step 7 Clean the glass panel with water and soap. Dry the glass panel carefully. Do not clean the glass panels in the dishwasher.

Step 8 After cleaning, do the above steps in the opposite sequence.

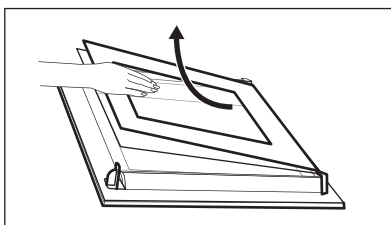

Step 9 Install the smaller panel first, then the larger and the door. Make sure that the glasses are inserted in the correct position otherwise the surface of the door may overheat.

10.5 How to replace: Lamp



WARNING!

Risk of electric shock.
The lamp can be hot.

Before you replace the lamp:

Step 1

Turn off the oven. Wait until the oven is cold.

Step 2

Disconnect the oven from the mains.

Step 3

Put a cloth on the bottom of the cavity.

Top lamp

Step 1 Turn the glass cover to remove it.

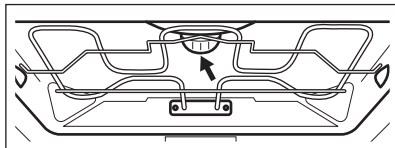

Step 2 Clean the glass cover.

Step 3 Replace the lamp with a suitable 300 °C heat-resistant lamp.

Step 4 Install the glass cover.

11. TROUBLESHOOTING



WARNING!

Refer to Safety chapters.

11.1 What to do if...

In any cases not included in this table please contact with an Authorised Service Centre.

Problem	Check if...
The oven does not heat up.	The fuse is blown.
The lamp does not work.	The lamp is burnt out.

11.2 Service data

If you cannot find a solution to the problem yourself, contact your dealer or an Authorised Service Centre.

The necessary data for the service centre is on the rating plate. The rating plate is on the front frame of the oven cavity. Do not remove the rating plate from the oven cavity.

We recommend that you write the data here:

Model (MOD.)

Product number (PNC)

Serial number (S.N.)

12. ENERGY EFFICIENCY

12.1 Product Information and Product Information Sheet*

Supplier's name	AEG
Model identification	EEB230010M 940321361
Energy Efficiency Index	95.3
Energy efficiency class	A
Energy consumption with a standard load, conventional mode	0.99 kWh/cycle
Energy consumption with a standard load, fan-forced mode	0.81 kWh/cycle
Number of cavities	1
Heat source	Electricity
Volume	71 l
Type of oven	Built-Under Oven
Mass	31.5 kg

* For European Union according to EU Regulations 65/2014 and 66/2014.
For Republic of Belarus according to STB 2478-2017, Appendix G; STB 2477-2017, Annexes A and B.
For Ukraine according to 568/32020.

Energy efficiency class is not applicable for Russia.

12.2 Energy saving



The oven has features which help you save energy during everyday cooking.

Make sure that the oven door is closed when the oven operates. Do not open the oven door too often during cooking. Keep the door gasket clean and make sure it is well fixed in its position.

Use metal cookware to improve energy saving.

When possible, do not preheat the oven before cooking.

Keep breaks between baking as short as possible when you prepare a few dishes at one time.

Cooking with fan

When possible, use the cooking functions with fan to save energy.

Residual heat

When the cooking duration is longer than 30 min, reduce the oven temperature to minimum 3 - 10 min before the end of cooking. The residual heat inside the oven will continue to cook.

Use the residual heat to warm up other dishes.

Keep food warm

Choose the lowest possible temperature setting to use residual heat and keep a meal warm.

Moist Fan Baking

Function designed to save energy during cooking.

13. ENVIRONMENTAL CONCERNS

Recycle materials with the symbol . Put the packaging in relevant containers to recycle it. Help protect the environment and human health by recycling waste of electrical and electronic appliances. Do not dispose of

appliances marked with the symbol  with the household waste. Return the product to your local recycling facility or contact your municipal office.

TÄYDELLISIÄ TULOKSIA

Kiitos, kun valitsit tämän AEG-tuotteen. Olemme luoneet sen antamaan sinulle moitteettoman suorituskyvyn monien vuosien ajan innovatiivisilla tekniikoilla, jotka helpottavat elämää – nämä ovat ominaisuuksia, joita et ehkä löydä tavallisista laitteista. Käytä muutama minuutti aikaasi lukeaksesi, kuinka saat kaiken kaiken hyödyn irti laitteesta.

Vieraile verkkosivullamme:



Saat käyttöön liittyviä neuvoja, esitteitä, vianmääritysohjeita sekä huolto- ja korjausohjeita:

www.aeg.com/support



Rekisteröi tuotteesi saadaksesi parempaa huoltoa:

www.registeraeg.com



Osta laitteeseesi lisävarusteita, kulutustuotteita ja alkuperäisiä varaosia:

www.aeg.com/shop

ASIAKASPALVELU

Käytä aina alkuperäisiä varaosia.

Pidä seuraavat tiedot saatavilla ottaessasi yhteyttä valtuutettuun huoltoliikkeeseemme:

Malli, PNC-tuotenumero, sarjanumero.

Tiedot löytyvät arvokilvestä.

 Varoitus / Varotoimi- ja turvallisuustietoja

 Yleistietoa ja vinkkejä

 Ympäristönsuojelutietoja

Oikeus muutoksiin pidätetään.

SISÄLTÖ

1. TURVALLISUUSTIEDOT.....	85
2. TURVALLISUUSOHJEET.....	87
3. TUOTEKUVAUS.....	90
4. KÄYTTÖPANEELI.....	90
5. ENNEN ENSIKÄYTTÖÄ.....	91
6. PÄIVITTÄINEN KÄYTTÖ.....	91
7. LISÄVARUSTEIDEN KÄYTTÄMINEN.....	92
8. LISÄTOIMINNOT.....	93
9. VIHJEITÄ JA NEUVOJA.....	93
10. HOITO JA PUHDISTUS.....	107
11. VIANMÄÄRITYS.....	110
12. ENERGIATEHOKKUUS.....	110

1. TURVALLISUUSTIEDOT

Lue laitteen mukana toimitetut ohjeet ennen laitteen asennusta ja käyttöä. Valmistaja ei ota vastuuta

henkilövahingoista tai vahingoista, jotka aiheutuvat virheellisestä asennuksesta tai käytöstä. Säilytä ohjeita aina varmassa ja helppopääsyisessä paikassa tulevia käyttökertoja varten.

1.1 Lasten ja taitamattomien henkilöiden turvallisuus

- 8-vuotiaat ja sitä vanhemmat lapset sekä henkilöt, joilla on fyysisiä, aisteihin liittyviä tai henkisiä rajoitteita tai puutteellinen kokemus tai tuntemus, voivat käyttää tätä laitetta vain, jos heitä valvotaan tai ohjataan laitteen turvallisessa käytössä ja jos he ymmärtävät käyttöön liittyvät vaarat. Tuote on pidettävä alle 8-vuotiaiden lasten ja erittäin laajoista ja monimutkaisista toiminnallisista rajoitteista kärsivien henkilöiden ulottumattomissa, ellei heitä valvota jatkuvasti.
- Lapsia on valvottava, jotta he eivät ryhdy leikkimään laitteella.
- Kaikki pakkaukset tulee pitää lasten ulottumattomissa ja hävittää asianmukaisesti.
- VAROITUS: Pidä lapset ja lemmikkieläimet pois uunin lähetyviltä sen ollessa toiminnassa tai jäähtymässä käytön jälkeen. Laitteen esillä olevat osat kuumentuvat käytön aikana.
- Jos laitteessa on lapsilukko, sitä on käytettävä.
- Lapset eivät saa puhdistaa laitetta tai suorittaa siihen kohdistuvia käyttäjän huoltotoimenpiteitä ilman valvontaa.

1.2 Yleinen turvallisuus

- Laitteen asennuksen ja virtajohdon vaihtamisen saa suorittaa vain alan ammattilainen.
- Älä käytä laitetta ennen kuin se on asennettu kalusteeseen.
- Irrota laite sähköverkosta ennen huoltotoimenpiteiden suorittamista.
- Jos virtajohto vaurioituu, sen saa sähkövaaran välttämiseksi vaihtaa vain valmistaja, valtuutettu huoltoliike tai vastaava ammattitaitoinen henkilö.

- Vaaratilanteiden välttämiseksi käyttöpaneeli tulee liittää määritettyyn lämmitysyksikköön yhdistämällä liittimet vastaavien värien perusteella.
- Virrankatkaisulaite tulee integroida pysyvään johdotukseen johdotussäätöjen mukaisesti.
- VAROITUS: Varmista ennen lampun vaihtoa, että laite on pois päältä. Näin vältät mahdollisen sähköiskun.
- VAROITUS: Laite ja näkyvissä olevat osat kuumenevat käytön aikana. Varo koskettamasta uunin lämmitysvastuksia.
- Käytä aina uunikintaita, kun käsittelet lisävarusteita tai uunivuokia.
- Poista kannatinkiskot vetämällä ensin kannatinkiskon etuosasta ja sen jälkeen takaosa irti sivuseinistä. Kiinnitä kannattimet takaisin paikalleen suorittamalla toimenpiteet päinvastaisessa järjestyksessä.
- Laitteen puhdistuksessa ei saa käyttää painepesuria.
- Älä käytä hankausaineita tai teräviä metallikaapimia lasiluukun puhdistamisessa, sillä ne voivat naarmuttaa pintaa, mistä voi olla seurauksena luukun lasin särkyminen.

2. TURVALLISUUSOHJEET

2.1 Asennus



VAROITUS!

Asennuksen saa suorittaa vain ammattitaitoinen henkilö.

- Poista kaikki pakkausmateriaalit.
- Vaurioitunutta laitetta ei saa asentaa tai käyttää.
- Noudata koneen mukana toimitettuja asennusohjeita.
- Siirrä laitetta aina varoen, sillä se on raskas. Käytä aina suojakäsineitä ja suojaavia jalkineita.
- Älä koskaan vedä laitetta sen kahvasta kiinni pitäen.
- Asenna laite turvalliseen ja sopivaan paikkaan, joka täyttää asennusvaatimukset.
- Keittiön kaapin ja asennuspaikan on oltava saman kokoiset.

- Noudata mainittuja vähimmäisetäisyyksiä muihin laitteisiin ja kalusteisiin.
- Tarkista ennen laitteen asentamista, että uuninluukku avautuu esteettä.
- Laitteen osat ovat jännitteenalaisia. Sulje laite kalusteella estääksesi pääsyn vaarallisiin osiin.
- Laite on varustettu sähkötoimisella jäähdytysjärjestelmällä. Sitä on käytettävä sähkösyötöllä.
- Kalusteisiin asennettavan yksikön on täytettävä standardin DIN 68930 asettamat vaatimukset.

Kaapin vähimmäiskorkeus (työtason alla olevan kaapin vähimmäiskorkeus)	578 (600) mm
--	--------------

Kaapin leveys	560 mm
---------------	--------

Kaapin syvyys	550 (550) mm
---------------	--------------

Laitteen etuosan korkeus	594 mm
Laitteen takaosan korkeus	576 mm
Laitteen etuosan leveys	595 mm
Laitteen takaosan leveys	559 mm
Laitteen syvyys	567 mm
Laitteen asennussyvyys	546 mm
Leveys luukun ollessa auki	1027 mm
Tuuletusaukon vähimmäiskoko. Aukko alaosassa takana	560 x 20 mm
Kiinnitysruuvit	4 x 25 mm

2.2 Sähkökytkentä



VAROITUS!

Tulipalo- ja sähköiskuvaara.

- Kaikki sähkökytkennät tulee jättää asiantuntevan sähköasentajan vastuulle.
- Laite on kytkettävä maadoitettuun pistorasiaan.
- Varmista, että arvokilvessä olevat parametrit ovat verkkovirtalähteen sähköarvojen mukaisia.
- Kytke pistoke maadoitettuun pistorasiaan.
- Älä käytä jakorasioita tai jatkojohtoja.
- Varmista, ettei pistoke ja virtajohto vaurioidu. Jos virtajohto joudutaan vaihtamaan, vaihdon saa suorittaa vain valtuutettu huoltoliike.
- Älä anna virtajohtojen koskettaa laitteen luukkuja tai päästä niitä luukun tai laitteen alapuolella olevan asennustilan lähelle, varsinkin laitteen ollessa toiminnassa tai luukun ollessa kuuma.
- Jännitteenalaisten ja eristettyjen osien suojat tulee asentaa niin, ettei niiden irrotus onnistu ilman työkaluja.
- Kytke pistoke pistorasiaan vasta asennuksen jälkeen. Varmista, että laitteen verkkovirtakytkentä on ulottuvilla laitteen asennuksen jälkeen.
- Jos pistoke on löysästi kiinni virtajohdossa, älä kiinnitä sitä pistorasiaan.
- Älä vedä virtajohdosta pistoketta irrottaessasi. Vedä aina pistokkeesta.
- Käytä vain asianmukaisia eristyslaitteita: suojakytkimet, sulakkeet (ruuvattavat

sulakkeet on irrotettava kannasta), vikavirtakytkimet ja kontaktorit.

- Sähköasennuksessa on oltava erotin, joka mahdollistaa laitteen irrottamisen sähköverkosta kaikista navoista. Erottimen kontaktiaukon leveys on oltava vähintään 3 mm.
- Laitteen mukana toimitetaan päävirtajohto ja pääpistoke.

2.3 Valitse



VAROITUS!

Henkilövahinkojen, palovammojen ja sähköiskujen tai räjähdysvaara.

- Tämä laite on tarkoitettu ainoastaan kotitalouskäyttöön.
- Älä muuta laitteen teknisiä ominaisuuksia.
- Varmista, että tuuletusaukoissa ei ole tukoksia.
- Laitetta ei saa jättää päälle valvomatta.
- Kytke laite pois päältä jokaisen käyttökerran jälkeen.
- Noudata varovaisuutta avatessasi laitteen luukun laitteen ollessa toiminnassa. Laitteesta voi purkautua ulos kuumaa ilmaa.
- Älä käytä laitetta, jos kätesi ovat märät tai laitteen ollessa kosketuksessa veteen.
- Älä kohdistaa painetta avoimeen oveen.
- Älä käytä laitetta työtasona tai tavaroiden säilytystasona.
- Avaa laitteen luukku varovaisuutta noudattaen. Alkoholi- ja ainesosien käyttämisen tuloksena voi muodostua alkoholin ja ilman seoksia.
- Älä päästä kipinöitä tai avotulta kosketukseen laitteen kanssa avatessasi sen luukun.
- Älä aseta helposti syttyviä tuotteita tai helposti syttyvien aineiden kanssa kosketuksissa olleita tuotteita laitteeseen, laitteen päälle tai sen lähelle.



VAROITUS!

Laite voi muutoin vaurioitua.

- Estä emalipinnan vaurioituminen tai haalistuminen:
 - Älä aseta ruoanlaittovälineitä tai muita esineitä laitteeseen siten, että ne olisivat suorassa kosketuksessa laitteen pohjan kanssa.

- Älä aseta alumiinifoliota siten, että se olisi suorassa kosketuksessa laitteen pohjan kanssa.
- Älä laita vettä suoraan kuumaan laitteeseen.
- Älä säilytä kosteita astioita tai ruokia laitteessa lopetettuasi ruoanlaiton.
- Noudata varovaisuutta poistaessasi tai asentaessasi lisäosia.
- Uunin emalipintojen tai ruostumattoman teräksen värimuutokset eivät vaikuta laitteen toimintaan.
- Käytä syvää pannua kosteita kakkuja paistaessasi. Hedelmämeihat voivat jättää pysyviä tahroja.
- Tämä laite on tarkoitettu ainoastaan ruoanlaittoon. Laitetta ei saa käyttää muihin tarkoituksiin, kuten esimerkiksi huoneen lämmittämiseen.
- Laitteen luukku on pidettävä suljettuna käytön aikana.

2.4 Hoito ja puhdistus



VAROITUS!

Ne voivat aiheuttaa henkilövahinkoja, tulipaloja tai laitteen vaurioitumisen.

- Kytke laite pois toiminnasta ja irrota pistoke pistorasiasta ennen ylläpitotoimien aloittamista.
- Tarkista, että laite on kylmä. Vaarana on lasilevyjen rikkoutuminen.
- Vaihda välittömästi vaurioituneet luukun lasipaneelit. Ota yhteyttä valtuutettuun huoltoliikkeeseen.
- Ole varovainen irrottaessasi luukkuja. Luukku on painava!
- Puhdista laite säännöllisesti, jotta pintamateriaali ei vaurioidu.
- Puhdista laite kostealla pehmeällä liinalla. Käytä ainoastaan mietoja pesuaineita. Älä käytä hankausainetta, hankaavia pesulappuja, liuottimia tai metalliesineitä.

- Jos käytät uuninpuhdistussuihketta, noudata tuotepakkauksessa olevia turvallisuusohjeita.

2.5 Sisävalo



VAROITUS!

Sähköiskun vaara.

- Lisätietoa tämän tuotteen sisällä olevista lamputa sekä erikseen myytävistä varalampuista: Kyseiset lamput on suunniteltu kestäämään kodinkoneissa vaativia fyysisiä olosuhteita (esim. lämpötila, värinä, kosteus) tai ne antavat tietoa laitteen toimintatilasta. Niitä ei ole tarkoitettu muihin käyttötarkoituksiin eivätkä ne sovi huoneiden valaisemiseen.
- Käytä ainoastaan ominaisuuksiltaan samanlaisia lampuja.

2.6 Huoltopalvelu

- Kun laite on korjattava, ota yhteyttä valtuutettuun huoltopalveluun.
- Käytä vain alkuperäisiä varaosia.

2.7 Hävittäminen



VAROITUS!

Henkilövahinko- tai tukehtumisvaara.

- Kysy tietoja laitteen oikeaoppisesta hävittämisestä paikalliselta viranomaiselta.
- Irrota pistoke pistorasiasta.
- Leikkaa virtajohto laitteen läheltä ja hävitä se.
- Poista luukun lukitus, jotta lapset, tai lemmikit eivät jäisi loukkuun laitteen sisälle.

3. TUOTEKUVAUS

3.1 Laitteen osat

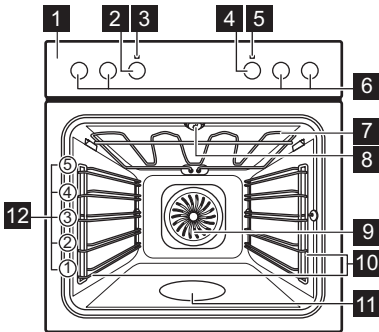

- 1 Käyttöpaneeli
- 2 Uunitoimintojen kiertonuppi
- 3 Virran merkkivalo / symboli
- 4 Säätonuppi (lämpötilan valitsemiseen)
- 5 Lämpötilan merkkivalo / symboli
- 6 Nupit keittoalueille
- 7 Lämpövastus
- 8 Lamppu
- 9 Puhallin
- 10 Hyllykannatin, irrotettava
- 11 Lokero
- 12 Hyllytasot

3.2 Varusteet

Paistoritilä

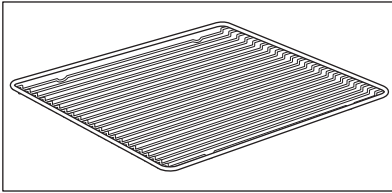

Ruoanlaittovälineille, kakkuvuokat, paistit.

Combi-pannu

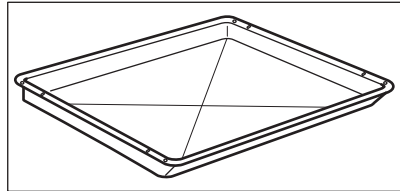

Kakuille ja kekseille. Paistamiseen tai pannuna rasvan keräämiseen.

4. KÄYTTÖPANEELI

4.1 Keittoalueiden säätimet

Keittotasoa käytetään keittoalueiden vääntimillä.



Lue keittotason käyttöoppaan "Turvallisuusohjeet" -luvut.

4.2 Tehotasot

Vääntimen osoitin	Toiminto
0	Pois toiminnasta
	Lämpimänäpito

Vääntimen osoitin	Toiminto
1 - 9	Tehotasot

1. Käännä säädin haluamasi tehotason kohdalle.

2. Kun lopetat keittoalueen käytön, käännä säädin off-asentoon.

4.3 Automaattinen kuumennus



Koskee vain keittotasoa, jossa on automaattinen kuumennustoiminto.

Automaattinen kuumennus kuumentaa keittoaluetta jonkin aikaa täydellä teholla.

1. Käännä keittoalueen väännintä myötäpäivään ääriasentoon (suurimman tehotason ohii).
2. Aseta välittömästi haluttu tehotaso.
3. Poista toiminto käytöstä kääntämällä väännin off-asentoon.

4.4 Kaksoiskeittoalueen käyttö (jos olemassa)



Kytke kaksoiskeittoalue toimintaan kääntämällä väännintä myötäpäivään. Älä käännä sitä pysäytysasennon kautta.

1. Käännä väännin myötäpäivään asentoon 9.
2. Käännä väännin hitaasti kohdalle, kunnes kuulet napsahduksen. Kaksoiskeittoalue on tällöin toiminnassa.
3. Aseta haluttu tehotaso kohdan "Tehotasot" mukaan.

5. ENNEN ENSIKÄYTTÖÄ



VAROITUS!

Lue turvallisuutta koskevat luvut.

5.1 Ennen ensimmäistä käyttökertaa

Uunista voi tulla hajua ja savua esikuumennuksen aikana. Varmista huoneen hyvä tuuletus.



1. vaihe

Puhdista uuni

1. Poista kaikki varusteet ja irrotettavat uunipeltien kannattimet uunista.
2. Puhdista uuni ja varusteet lämpimällä vedellä ja miedolla pesuaineella käyttäen pehmeää puhdistusliinaa.



2. vaihe

Esikuumenna tyhjä uuni

1. Aseta toiminnon enimmäislämpötila: .
Aika: 1 tunti.
2. Aseta toiminnon enimmäislämpötila: .
Aika: 15 min.

Kytke uuni pois päältä ja odota, että se jäähtyy. Aseta varusteet ja irrotettavat uunipeltien kannattimet uuniin.

6. PÄIVITTÄINEN KÄYTTÖ



VAROITUS!

Lue turvallisuutta koskevat luvut.









6.1 Asettaminen: Uunitoiminto



1. vaihe Käännä uunin toimintojen väännintä uunitoiminnon valitsemiseksi.

2. vaihe Valitse lämpötila kääntämällä väännintä.

3. vaihe Kun ruoka on valmista, käännä vääntimet Off-asentoon uunin sammuttamiseksi.

6.2 Uunitoiminnot

Uunitoiminto	Käyttötarkoitus
 Pois toiminnasta	Uuni on kytketty pois päältä.
 Uunivalo	Lampun sytyttäminen.
 Kiertoilma	Korkeintaan kolmella kannatin- tasolla kypsentäminen samanai- kaisesti ja ruokien kuivaus. Aseta lämpötila 20–40 °C alhai- semmaksi kuin toiminnolle Ylä- / alalämpö.
 Pizza-toiminto	Pizzan valmistaminen. Voimak- kaaseen ruskistamiseen ja ra- peen pohjan luomiseen.
 Ylä- /alalämpö	Kypsentäminen ja paistaminen yhdellä tasolla.
 Alalämpö	Kakkujen paistamiseksi rapealla pohjalla ja ruoan säilömiseksi.
 Sulatus	Ruoan, (hedelmien ja vihannes- ten) sulattaminen. Sulatusai- kaan vaikuttavat pakastetun ruoan määrä ja koko.
 Kosteaa kiertoilma	Tämä toiminto säästää energiaa ruoanlaiton aikana. Kun käytät tätä toimintoa, uunin sisälämpö- tila voi poiketa lämpötila-asetuk- sesta. Kuumennusteho voi las- kea. Katso lisätietoa luvusta "Päivittäinen käyttö", Huomau- tus: Kosteaa kiertoilma:

Uunitoiminto	Käyttötarkoitus
 Grilli	Ohuiden ruokien grillaus ja lei- vän paattaminen.
 Teho grillaus	Isokojen, luisten liha- tai lintu- paistien paistamiseen yhdessä ritiläasennossa. Gratinointi ja ruskistus.

 Joissakin uunitoiminnoissa
lamppu voi sammua
automaattisesti alle 60 °C
lämpötilassa.

6.3 Huomautus: Kosteaa kiertoilma

Tämän toiminnon avulla määritettiin
energiatehokkuusluokka vastaamaan
standardeja EU 65/2014 ja EU 66/2014.
Testit standardin EN 60350-1 mukaisesti.

Uunin luukun on oltava kiinni ruoanlaiton
aikana, jotta toiminto ei keskeytyisi ja uunin
energiatehokkuus olisi mahdollisimman suuri.

Ruoanlaitto-ohjeet löytyvät luvusta "Neuvoja
ja vinkkejä", Kosteaa kiertoilma.
Yleissuosituksia energiansäästämiseksi on
luvussa "Energiatehokkuus".

7. LISÄVARUSTEIDEN KÄYTTÄMINEN



VAROITUS!

Lue turvallisuutta koskevat luvut.

7.1 Lisävarusteiden asennus

Pieni lovi yläosassa parantaa turvallisuutta.
Lovet estävät myös kallistumisen. Ritilän

yläreuna estää keittoastioiden luisumisen
kannatintasolta.

Uuniritilä:

Paina ritilä liukukiskojen väliin kannattimeen.

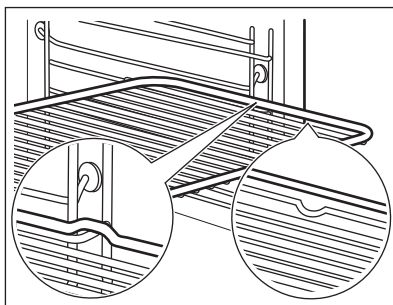
**Uunipannu:**

Työnnä pelti haluamasi ohjauskiskojen väliin.

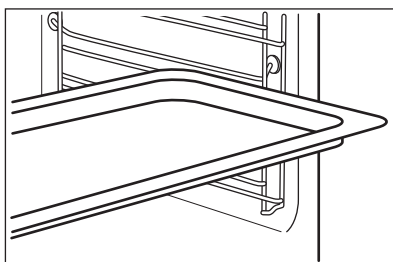
**Uuniritilä, Uunipannu:**

Paina leivinpelti kannatinkiskon ohjauskiskojen väliin ja paistoritilä yläpuolella oleviin ohjauskiskoihin.

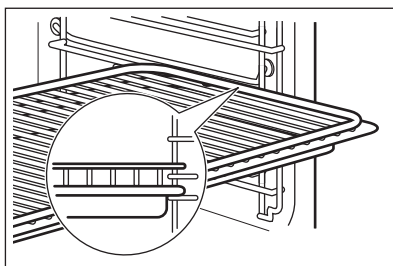

8. LISÄTOIMINNOT

8.1 Jäähdytyspuhallin

Kun uuni on toiminnassa, jäähdytyspuhallin kytkeytyy automaattisesti toimintaan uunin

pintojen pitämiseksi viileinä. Kun kytket uunin pois toiminnasta, jäähdytyspuhallin toimii edelleen, kunnes uuni on jäähtynyt.

9. VIHJEITÄ JA NEUVOJA



Lue turvallisuutta koskevat luvut.

9.1 Esimerkkejä keittotason keittotoiminnoista

Tehotaso	Käyttötarkoitus	Aika (min)	Vinkkejä
1	Kypsiin ruokien lämpimänä pitäminen.	tarpeen mukaan	Aseta keittoastian päälle kansi.
1 - 2	Hollandaisekastikkeen valmistaminen ja voin, suklaan ja liiviatteen sulattaminen.	5 - 25	Sekoita aika ajoin.
1 - 2	Munakkaiden ja munajuuston kiinteyttäminen.	10 - 40	Valmista kannen alla.
2 - 3	Riisin ja maitoruokien haudutus, valmisruokien kuumentaminen.	25 - 50	Lisää vähintään kaksinkertainen määrä nestettä riisimäärään verrattuna. Sekoita maitoruokia puolivälissä.
3 - 4	Vihanneksien, kalan ja lihan höyrytys.	20 - 45	Lisää joitakin ruokalusikallisia nestettä.
4 - 5	Perunoiden höyrytys.	20 - 60	Käytä korkeintaan 1/4 litraa vettä/750 g perunoita.
4 - 5	Suurten ruokamäärien, pataruokien ja keittojen valmistaminen.	60 - 150	Lisää aineksiin korkeintaan 3 litraa nestettä.
6 - 7	Leikkeiden, Cordon bleu -vasikanleikkeiden, kyljyksien, pyöryköiden, makkaroiden, maksan, kananmunien, pannukakujen ja donitsien kevyt friteeraus sekä jauhosuuruksen valmistaminen.	tarpeen mukaan	Käännä kypsennyksen puolivälissä.
7 - 8	Sipuliperunoiden, ulkofileen ja pihvien voimakas paistaminen.	5 - 15	Käännä kypsennyksen puolivälissä.
9	Suuren vesimäärän keittäminen, pastan keittäminen, lihan ruskistaminen (gulassi, patapaisti) ja ranskalaisten friteeraus.		

9.2 Ruoanlaittoon liittyviä suosituksia



Taulukoissa mainitut lämpötilat ja paistoaajat ovat ainoastaan suuntaa-antavia. Lämpötila ja paistoaika riippuvat reseptistä sekä käytettyjen aineiden laadusta ja määrästä. Uunisi voi paistaa eri tavalla kuin entinen uunisi. Alla olevat taulukot sisältävät suosittelut lämpötilat, kypsennysajat ja kannatintasot eri ruokalajeihin. Jos taulukosta ei löydy reseptiisi sopivia asetuksia, voit soveltaa jonkin samantyyppisen paistoksen asetuksia.

9.3 Paistaminen

Käytä alhaisempaa lämpötilaa ensimmäisellä paistokerralla.

Jos paistat useammalla kuin yhdellä kannatintasolla, voit pidentää paistoaikaa 10 – 15 minuuttia.

Eri kannatintasolla olevat leivonnaiset voivat ruskistua epätasaisesti. Lämpötila-asetusta





ei tarvitse muuttaa, jos ruskistuminen on epätasaista. Erot tasaantuvat paistumisen jatkuessa.

Uunissa olevat pellit voivat vääntyä paistamisen aikana. Jäähdyessään uunipellit palautuvat kuitenkin alkuperäiseen muotoonsa.

9.4 Leivontavinkkejä

Leivontatulos	Mahdollinen syy	Korjaustoimenpide
Kakun pohja ei ole riittävän kypsä.	Kannatintaso on virheellinen.	Laita kakku alemmalle kannatintasolle.
Kakku laskeutuu, se on taikimainen tai liian kostea.	Uunin lämpötila on liian korkea.	Käytä seuraavalla kerralla hiukan alhaisempaa lämpötilaa.
	Liian korkea paistolämpötila ja liian lyhyt paistoaika.	Aseta seuraavalla kerralla pitempi paistoaika ja alhaisempi lämpötila.
Kakku on liian kuiva.	Uunin lämpötila on liian matala.	Käytä seuraavalla kerralla hiukan korkeampaa lämpötilaa.
	Liian pitkä paistoaika.	Aseta seuraavalla kerralla lyhyempi paistoaika.
Kakku kypsyy epätasaisesti.	Liian korkea paistolämpötila ja liian lyhyt paistoaika.	Aseta seuraavalla kerralla pitempi paistoaika ja alhaisempi lämpötila.
	Kakkutaikina ei ole jakautunut tasanaisesti.	Levitä kakkutaikina seuraavalla kerralla tasanaisesti leivinpeltiin.
Kakku ei paistu reseptissä ilmoitetussa paistojassa.	Uunin lämpötila on liian matala.	Käytä seuraavalla kerralla hiukan korkeampaa lämpötilaa.

9.5 Paistaminen yhdellä kannatintasolla

 VUOASSA PAISTETUT LEIVONNAISET		 (°C)	 (min)	
Kakkupohja murotaikinasta, uunin esikuuminen tyhjänä	Kiertoilma	170 - 180	10 - 25	2
Torttupohja vatka-tusta taikinasta	Kiertoilma	150 - 170	20 - 25	2
Maustekakku / Briossi	Kiertoilma	150 - 160	50 - 70	1
Maustekakku / Hedelmäkakut	Kiertoilma	140 - 160	70 - 90	1
Juustokakku	Ylä- /alalämpö	170 - 190	60 - 90	1

Käytä kolmatta kannatintasoa.

Valitse toiminto: Kiertoilma.

Käytä leivinpeltiä.

**KAKUT / LEIVONNAISET / LEIVÄT****(°C)****(min)**

Strösselkakku

150 - 160

20 - 40

Marja-/hedelmäpirakka (hiivataikina / vatkattu taikina), käytä uunipannua

150

35 - 55

Marja-/hedelmäpirakka, murotaikinapohja

160 - 170

40 - 80

Esikuumenna tyhjää uunia.

Valitse toiminto: Ylä- /alalämpö.

Käytä leivinpeltiä.

**KAKUT / LEIVONNAISET / LEIVÄT****(°C)****(min)**

Kääretorttu

180 - 200

10 - 20

3

Ruisleipä:

ensin: 230

20

1

myöhemmin: 160 - 180

30 - 60

Voilla leivottu mantelikkaku / Sokerikkakut

190 - 210

20 - 30

3

Tuulihatut / Eclair-leivokset

190 - 210

20 - 35

3

Pullapitko / Pullakranssi

170 - 190

30 - 40

3

Marja-/hedelmäpirakka (hiivataikina / vatkattu taikina), käytä uunipannua

170

35 - 55

3

Pellillä paistetut leivonnaiset, arkalaatuinen täyte (esim. rahka, kerma, vaniljakastike)

160 - 180

40 - 80

3

Joulupulla (stollen)

160 - 180

50 - 70

2

Käytä kolmatta kannatintasoa.

**PIKKULEIVÄT****(°C)****(min)**

Murotaikinapikkuleivät

Kiertoilma

150 - 160

10 - 20

Sämpylät, uunin esikuumennus tyhjänä

Kiertoilma

160





10 - 25

Pikkuleivät vatkatusta taikinasta

Kiertoilma





150 - 160

15 - 20

 PIKKULEIVÄT		 (°C)	 (min)
Lehtitaikeinaleivonnaiset, uunin esikuumennus tyhjänä	Kiertoilma	170 - 180	20 - 30
Pikkuleivät hiivataikinasta	Kiertoilma	150 - 160	20 - 40
Macaronit	Kiertoilma	100 - 120	30 - 50
Munanvalkuaisleivonnaiset / Marengit	Kiertoilma	80 - 100	120 - 150
Sämpylät, uunin esikuumennus tyhjänä	Ylä- /alalämpö	190 - 210	10 - 25

9.6 Paistokset ja gratiinit





Käytä ensimmäistä kannatintasoa.

		 (°C)	 (min)
Juustokuorrutetut patongit	Kiertoilma	160 - 170	15 - 30
Vihannesgratiini, uunin esikuumennus tyhjänä	Teho grillaus	160 - 170	15 - 30
Lasagne	Ylä- /alalämpö	180 - 200	25 - 40
Kalalaatikko	Ylä- /alalämpö	180 - 200	30 - 60
Täytetyt vihannekset	Kiertoilma	160 - 170	30 - 60
Makeat kohokkaat	Ylä- /alalämpö	180 - 200	40 - 60
Makaronilaatikko	Ylä- /alalämpö	180 - 200	45 - 60

9.7 Paistaminen useilla kannatintasoilla

Valitse toiminto: Kiertoilma.

Käytä leivinpeltiä.

 KAKKU/ PIIRAKKA	 (°C)	 (min)	 2 tasoa
Tuulihatut / Eclair-leivokset, uunin esikuumennus tyhjänä	160 - 180	25 - 45	1 / 4
Strösselkakku, kuiva	150 - 160	30 - 45	1 / 4



**PIKKU-
LEIVÄT / PIENET
KAKUT / LEI-
VONNAISET /
SÄMPYLÄT**



(°C)



(min)



2 tasoa

3 tasoa

	(°C)	(min)	2 tasoa	3 tasoa
Sämpylät	180	20 - 30	1 / 4	-
Murotaikinapikkulei- vät	150 - 160	20 - 40	1 / 4	1 / 3 / 5
Pikkuleivät vatka- ta taikinasta	160 - 170	25 - 40	1 / 4	-
Lehtitaikinaleivon- naiset, uunin esikuu- mennus tyhjänä	170 - 180	30 - 50	1 / 4	-
Pikkuleivät hiivatai- nasta	160 - 170	30 - 60	1 / 4	-
Macaronit	100 - 120	40 - 80	1 / 4	-
Munanvalkuaislei- vonnaiset / Marengit	80 - 100	130 - 170	1 / 4	-

9.8 Vinkkejä paistamiseen

Käytä lämmönkestäviä uunivuokia.

Paista vähärasvaista lihaa peitettynä (voit käyttää alumiinifoliota).

Aseta suurikokoiset paistit suoraan paistoastiaan tai paistoritilän päälle, jonka alla on paistoastia.

Kaada hiukan nestettä paistoastiaan, jotta valuva rasva ei pala.

Käännä paistia, kun paistoajasta on kulunut 1/2 - 2/3.

Paista liha tai kala suurina (vähintään 1 kg:n) palasina.

Valele paistien päälle niistä tulevia nesteitä useita kertoja paistamisen aikana.

9.9 Lihan paistaminen

Käytä ensimmäistä kannatintasoa.



NAUDANLIHA



(°C)



(min)

			(°C)	(min)
Patapaisti	1 - 1,5 kg	Ylä- /alalämpö	230	120 - 150
Paahtopaisti tai filee, raaka, uunin esikuumen- nus tyhjänä	per paksuus/cm	Teho grillaus	190 - 200	5 - 6
Paahtopaisti tai filee, puolikypsä, uunin esikuu- mennus tyhjänä	per paksuus/cm	Teho grillaus	180 - 190	6 - 8



NAUDANLIHA



(°C)



(min)

Paahtopaisti tai filee,
kypsä, uunin esikuumen-
nus tyhjänä

per paksuus/cm

Teho grillaus

170 - 180

8 - 10



PORSAANLIHA



Valitse toiminto: Teho grillaus.



(kg)



(°C)



(min)

Lapa / Niska / Kinkku

1 - 1,5

160 - 180

90 - 120

Kyljykset / Siankyliki

1 - 1,5

170 - 180

60 - 90

Lihamureke

0,75 - 1

160 - 170

50 - 60

Porsaan potkapaisti, esikyp-
sennetty

0,75 - 1

150 - 170

90 - 120



VASIKANLIHA



Valitse toiminto: Teho grillaus.



(kg)



(°C)



(min)

Vasikanpaisti

1

160 - 180

90 - 120

Vasikan reisa paisti

1,5 - 2

160 - 180

120 - 150



LAMMAS



Valitse toiminto: Teho grillaus.



(kg)



(°C)



(min)

Lampaanreisi / Lammas-
paisti

1 - 1,5

150 - 170

100 - 120

Lampaanselkä

1 - 1,5

160 - 180

40 - 60



RIISTA



Valitse toiminto: Ylä- /alalämpö.



(kg)



(°C)



(min)

Selkä / Jäniksenkoipi, uu-
nin esikuuminen tyhjänä

korkeintaan 1

230

30 - 40

Kauriin-/hirsensatula

1,5 - 2

210 - 220

35 - 40

Kauriin-/hirvenreisi

1,5 - 2

180 - 200

60 - 90



LINTUPAISTI



Valitse toiminto: Teho grillaus.



(kg)



(°C)



(min)

Linnunliha, paloina

0,2 - 0,25 kpl

200 - 220

30 - 50

Puolikas kana

0,4 - 0,5 kpl

190 - 210

35 - 50

Broileri, kana

1 - 1,5

190 - 210

50 - 70

Ankka

1,5 - 2

180 - 200

80 - 100

Hanhi

3,5 - 5

160 - 180

120 - 180

Kalkkuna

2,5 - 3,5

160 - 180

120 - 150

Kalkkuna

4 - 6

140 - 160

150 - 240



KALA (HAUDUTETTU)



Valitse toiminto: Ylä- /alalämpö.



(kg)



(°C)



(min)

Kokonainen kala

1 - 1,5

210 - 220

40 - 60

9.10 Rapea pinta: Pizza-toiminto



PIZZA



Käytä ensimmäistä kannatintasoa.



(°C)



(min)

Tortut

180 - 200

40 - 55

Pinaattipiiras

160 - 180

45 - 60

Kinkkupiiras /
Sveitsiläinen
juustopiirakka

170 - 190

45 - 55

Juustokakku

140 - 160

60 - 90

Vihannespiiras

160 - 180

50 - 60



PIZZA



Esikuumenna tyhjää uunia ennen ruokien asettamista uuniin.



Käytä toista kannatintasoa.



(°C)



(min)

Pizza, ohut pohja, käytä uuni-
pannua

200 - 230

15 - 20



PIZZA



Esikuumenna tyhjää uunia ennen ruokien asettamista uuniin.



Käytä toista kannatintasoa.



(°C)



(min)

Pizza, paksu
pohja

180 - 200

20 - 30

Kohottamaton
leipä

230 - 250

10 - 20

Voitaikinapohjai-
nen piiras

160 - 180

45 - 55

Flammkuchen

230 - 250

12 - 20

Pierogi (Piiraat)

180 - 200

15 - 25

9.11 Grilli

Esikuumenna tyhjää uunia ennen ruokien asettamista uuniin.

Grillaa vain ohuita liha- tai kalapaloja.

Aseta pannu ensimmäiselle kannatintasolle rasvan keräämiseksi.



GRILLI



Valitse toiminto: Grilli



(°C)



(min)

1. puoli



(min)

2. puoli



	(°C)	(min) 1. puoli	(min) 2. puoli	
Paahtopaisti	210 - 230	30 - 40	30 - 40	2
Naudanfilee	230	20 - 30	20 - 30	3
Porsaankylkipaisti	210 - 230	30 - 40	30 - 40	2
Vasikankylkipaisti	210 - 230	30 - 40	30 - 40	2
Lampaanselkä	210 - 230	25 - 35	20 - 25	3
Kokonainen kala, 0,5 kg - 1 kg	210 - 230	15 - 30	15 - 30	3 / 4

9.12 Pakasteet



Sulatus



Valitse toiminto: Kiertoilma.



(°C)



(min)



	(°C)	(min)	
Pizza, pakaste	200 - 220	15 - 25	2
Pizza American, pakaste	190 - 210	20 - 25	2
Pizza, kylmä	210 - 230	13 - 25	2
Pizzapalat, pakaste	180 - 200	15 - 30	2
Ranskalaiset, ohuet	200 - 220	20 - 30	3
Ranskalaiset, paksut	200 - 220	25 - 35	3
Lohkoperunat / Krokettit	220 - 230	20 - 35	3
Röstiperunat	210 - 230	20 - 30	3
Lasagne / Cannelloni, tuore	170 - 190	35 - 45	2
Lasagne / Cannelloni, pakaste	160 - 180	40 - 60	2
Uunijuusto	170 - 190	20 - 30	3
Kanan siipipalat	190 - 210	20 - 30	2





9.13 Sulatus

Poista pakkausmateriaalit ja aseta ruoka lautaselle.

Älä peitä ruokaa, muutoin sulatusaika voi olla pitempi.

Käytä ensimmäistä kannatintaso.

Kun ruoka on suurikokoinen, aseta tyhjä lautanen ylösalaisin uunin pohjalle. Aseta ruoka syvään astiaan ja aseta se uunin sisällä olevan lautasen päälle. Poista tarvittaessa kannattimet.

	 (kg)	 (min) Sulatusaika	 (min) Jälkisulatusaika	
Kana	1	100 - 140	20 - 30	Käännä kypsennyksen puolivälissä.
Liha	1	100 - 140	20 - 30	Käännä kypsennyksen puolivälissä.
Taimen	0,15	25 - 35	10 - 15	-
Mansikat	0,3	30 - 40	10 - 20	-
Voi	0,25	30 - 40	10 - 15	-
Kerma	2 x 0,2	80 - 100	10 - 15	Vatkaa kerma, kun se on edelleen hiukan jäässä.
Gateau (perunalaa- tikko)	1,4	60	60	-

9.14 Säilöntä

Valitse toiminto Alalämpö.

Käytä ainoastaan samankokoisia kaupoista saatavilla olevia säilöntäpurkkeja.

Älä käytä kierrekorkillisia ja pikalukittavia lasipurkkeja tai metallitölkkejä.

Käytä ensimmäistä kannatintaso.

Aseta leivinpellille korkeintaan kuusi yhden litran säilöntäpurkkia.

Täytä purkit tasaisesti ja sulje tiiviisti.



Purkit eivät saa koskettaa toisiaan.



Kaada noin 1/2 litraa vettä leivinpellille, jotta uunissa on riittävästi kosteutta.

Kun neste alkaa kiehua kevyesti ensimmäisissä purkeissa (litran purkissa noin 35 - 60 minuutin kuluttua), katkaise virta uunista tai alenna lämpötila 100 °C:seen (katso taulukko).

Aseta lämpötila 160 - 170 °C.

 PEHMEÄT MARJAT/HEDELMÄT	 (min) Keittoaika kiehumiseen
Mansikat / Mustikat / Vadelmat / Kypsät karviaiset	35 - 45

 LUUHE- DELMÄT	 (min) Keittoaika kiehumiseen	 (min) Jatka keittämistä 100 °C:ssa
Persikat / Kvitte- nit / Luumut	35 - 45	10 - 15

 VI-HANNEKSET	 (min) Keittoaika kiehumiseen	 (min) Jatka keittä- mistä 100 °C:ssa
Porkkanat	50 - 60	5 - 10
Kurkut	50 - 60	-
Pikkelsi	50 - 60	5 - 10
Kyssäkaali / Herneet / Parsa	50 - 60	15 - 20

9.15 Kuivatukseen - Kiertoilma

Peitä pellit leivinpaperilla.

Saat paremman lopputuloksen, kun pysäytät uunin sen saavutettua kuivausajan puolivälin, avaat uunin luukun, ja annat sen jäähtyä ja kuivua yön yli.

Käytä yhden leivinpellin tapauksessa kolmatta hyllykannatintasoa.

Käytä kahden leivinpellin tapauksessa ensimmäistä ja neljättä hyllykannatintasoa.

9.16 Kostea kiertoilma - suositellut varusteet

Käytä tummia heijastamattomia vuokia ja astioita. Ne absorboivat enemmän lämpöä vaaleisiin ja heijastaviin astioihin verrattuna.

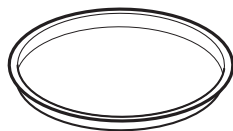

Pizzapannu

Tumma, heijastamaton
halkaisija 28 cm

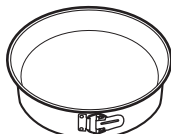

Uunivuoka

Tumma, heijastamaton
halkaisija 26 cm



Annosvuokat

Keraaminen
halkaisija 8 cm,
korkeus 5 cm

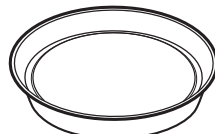



Torttuvuoka



Tumma, heijastamaton
halkaisija 28 cm





9.17 Kostea kiertoilma

Noudata alla olevan taulukon ehdotuksia parhaan tuloksen saavuttamiseksi.

 VIHANNEK-SET	 (°C)	 (tuntia)
Pavut	60–70	6–8
Paprikat	60–70	5–6
Keittovihannekset	60–70	5–6
Sienet	50–60	6–8
Yrtit	40–50	2–3

Aseta lämpötilaksi 60–70 °C.

 HEDELMÄT	 (tuntia)
Luumut	8–10
Aprikoosit	8–10
Omenaviipaleet	6–8
Päärynät	6–9

		 (°C)		 (min)
Makeat sämpylät, 16 kappaletta	leivinpelti tai uunipannu	190	3	45 - 55
Pizza, pakaste, 0,35 kg	ritilä	190	2	45 - 50
Kääretorttu	leivinpelti tai uunipannu	180	2	45 - 55
Brownie	leivinpelti tai uunipannu	180	2	55 - 60
Torttupohja	torttuvuoka ritilällä	180	2	40 - 50
Höyrytetty kala, 0,3 kg	leivinpelti tai uunipannu	180	3	25 - 35
Kokonainen kala, 0,2 kg	leivinpelti tai uunipannu	180	3	25 - 35
Kalafilé, 0,3 kg	pizzapannu ritilällä	180	3	40 - 50
Haudutettu liha, 0,25 kg	leivinpelti tai uunipannu	190	3	40 - 50
Shashlik, 0,5 kg	leivinpelti tai uunipannu	190	3	35 - 45
Pikkuleivät, 16 kappaletta	leivinpelti tai uunipannu	160	2	40 - 50
Macaronit, 24 kappaletta	leivinpelti tai uunipannu	150	2	35 - 45
Muffinssit, 12 kappaletta	leivinpelti tai uunipannu	160	2	35 - 45
Suolaiset leivonnaiset, 20 kappaletta	leivinpelti tai uunipannu	170	2	35 - 45
Murotaikinapikkuleivät, 20 kappaletta	leivinpelti tai uunipannu	150	2	40 - 45
Tortut, 8 kappaletta	leivinpelti tai uunipannu	170	2	35 - 45
Vihannekset, haudutetut, 0,4 kg	leivinpelti tai uunipannu	180	3	45 - 55
Kasvismunakas	pizzapannu ritilällä	190	3	40 - 50

9.18 Tietoja testilaitokselle

Testit seuraavan mukaisesti: EN 60350, IEC 60350.



PAISTAMINEN YHDELLÄ KANNATINTASOLLA. Vuoassa paistetut leivonnaiset



(°C)



(min)



Rasvaton sokerikakku	Kiertoilma	140 - 150	35 - 50	2
Rasvaton sokerikakku	Ylä- /alalämpö	160	35 - 50	2
Omenapiirakka, 2 vuokaa Ø20 cm	Kiertoilma	160	60 - 90	2
Omenapiirakka, 2 vuokaa Ø20 cm	Ylä- /alalämpö	180	70 - 90	1



PAISTAMINEN YHDELLÄ KANNATINTASOLLA. Pikkuleivät



Käytä kolmatta kannatintasoa.



(°C)



(min)

Murokeksit / Pasteijat	Kiertoilma	140	25 - 40	
Murokeksit / Pasteijat, uunin esi- kuumennus tyhjänä	Ylä- /alalämpö	160	20 - 30	
Pienet kakut, 20 kpl/pelti, uunin esikuumennus tyhjänä	Kiertoilma	150	20 - 35	
Pienet kakut, 20 kpl/pelti, uunin esikuumennus tyhjänä	Ylä- /alalämpö	170	20 - 30	



PAISTAMINEN USEILLA KANNATINTASOILLA. Pikkuleivät



(°C)



(min)



Murokeksit / Pasteijat	Kiertoilma	140	25 - 45	1 / 4
Pienet kakut, 20 kpl/pelti, uunin esikuumennus tyhjänä	Kiertoilma	150	23 - 40	1 / 4
Rasvaton sokerikakku	Kiertoilma	160	35 - 50	1 / 4



GRILLI



Esikuumenna tyhjää uunia 5 minuutin ajan.



Grillaa lämpötilan maksimiasetuksella.



(min)



Paahtoleipä

Grilli

1 - 3

5

Naudanlihapihvit, käännä kypsennyksen puolivälissä

Grilli

24 - 30

4

10. HOITO JA PUHDISTUS



VAROITUS!

Lue turvallisuutta koskevat luvut.

10.1 Puhdistukseen liittyviä huomautuksia



Puhdista uunin etupinnat lämpimällä vedellä ja miedolla pesuaineella käyttäen pehmeää puhdistusliinaa.

Käytä puhdistusainetta metallipintojen puhdistamiseen.

Poista tahrat miedolla pesuaineella.

Puhdistusaineet



Jokapäiväinen käyttö

Puhdista uunin sisäosa jokaisen käytön jälkeen. Rasvan tai muiden roiskeiden kertyminen voi johtaa tulipaloon.

Älä jätä ruokia uuniin 20 minuuttia pitemmäksi ajaksi. Kuivaa sisäosa pehmeällä liinalla jokaisen käyttökerran jälkeen.



Lisävarusteet

Puhdista kaikki lisävarusteet käytön jälkeen ja anna niiden kuivua. Käytä pehmeää liinaa, lämmintä vettä ja mietoja puhdistusainetta. Lisävarusteita ei saa pestä astianpesukoneessa.

Tarttumattomia lisävarusteita ei saa puhdistaa hankaavilla puhdistusaineilla tai teräväreunaisilla esineillä.

10.2 Irrottaminen: Kannattimet

Poista kannattimet uunin puhdistamiseksi.

- 1. vaihe** Kytke uuni pois toiminnasta ja odota, että se jäähtyy.
- 2. vaihe** Vedä uunipeltien kannattimen etuosa irti sivuseinästä.

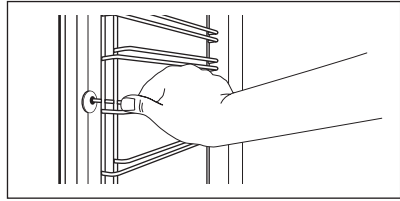

- 3. vaihe** Vedä kannattimen takaosa irti seinästä ja poista se.
- 4. vaihe** Kiinnitä kannattimet takaisin paikalleen suorittamalla toimenpiteet päinvastaisessa järjestyksessä.

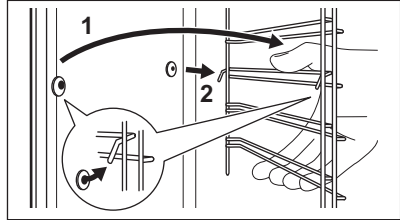

10.3 Irrottaminen: Grilli



VAROITUS!

Olemassa on palovammojen vaara.

- 1. vaihe** Kytke uuni pois toiminnasta ja puhdista se vasta sitten, kun se on jäähtynyt. Irrota ritilöiden kannattimet.
- 2. vaihe** Tartu grillin nurkkiin. Vedä sitä eteenpäin jousipainetta vastaan ja ulospäin molemmasta pidikkeestä. Grilli taittuu alaspäin.
- 3. vaihe** Puhdista uunin katto lämpimällä vedellä, pehmeällä liinalla ja miedolla pesuaineella. Anna sen kuivua.
- 4. vaihe** Asenna grilli noudattamalla ohjeita päinvastaisessa järjestyksessä.

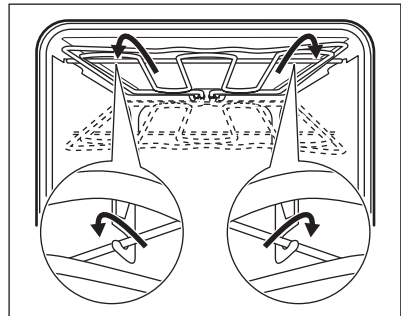

- 5. vaihe** Asenna ritilöiden kannattimet.

10.4 Irrottaminen ja asentaminen: Luukku

Voit poistaa luukun ja sisäiset lasilevyt niiden puhdistamiseksi. Lasipaneelin lukumäärä vaihtelee eri malleissa.



VAROITUS!

Luukku on painava.



HUOMIO!

Käsittele lasia varoen, tämä koskee erityisesti etupaneelin reunoja. Lasi voi rikkoontua.

- 1. vaihe** Avaa luukku kokonaan.
- 2. vaihe** Paina ja nosta saranoissa olevat lukitusvivut (A).

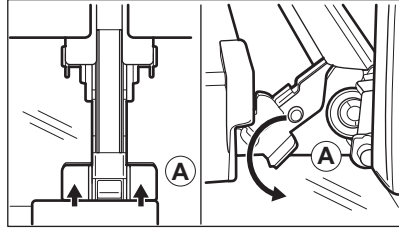

- 3. vaihe** Sulje uunin luukku ensimmäiseen avausasentoon (likimäärin 70° kulma). Tartu luukkuun kummaltakin puolelta ja vedä se irti uunista ylöspäin suuntautuvassa kulmassa. Aseta luukku sen ulkopinta alaspäin vakaalle pinnalle levitetyn liinan päälle.

- 4. vaihe** Pidä kiinni luukun reunalistasta (B) molemmin puolin luukun yläreunaa ja työnnä sisäänpäin vapauttaaksesi pinnetiivisteet.

- 5. vaihe** Irrota luukun reunalista vetämällä sitä eteenpäin.

- 6. vaihe** Tartu lasilevyihin yläreunasta ja vedä ne yksi kerrallaan ulos sivulla olevista kiskoista.

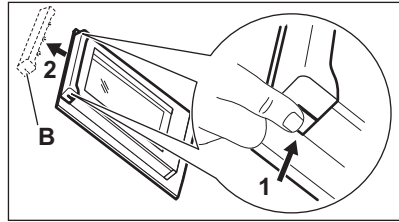

- 7. vaihe** Puhdista lasipaneeli vedellä ja saippualla. Kuivaa lasipaneeli huolellisesti. Lasilevyjä ei saa pestä astianpesukoneessa.

- 8. vaihe** Suorita edellä kuvatut vaiheet päinvastaisessa järjestyksessä puhdistamisen jälkeen.

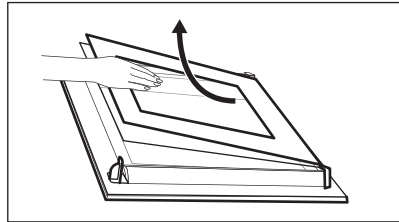

- 9. vaihe** Kiinnitä ensiksi pienin lasilevy, sitten suurempi ja lopuksi luukku. Varmista, että lasit on asetettu oikeaan asentoon. Muutoin luukun pinta voi ylikuumentua.

10.5 Vaihdaminen: Lamppu



VAROITUS!

Sähköiskun vaara.
Lamppu voi olla kuuma.

Ennen lampun vaihtamista:

1. vaihe	2. vaihe	3. vaihe
Kytke uuni pois päältä. Odota, kunnes uuni on jäähtynyt.	Irrota uunin pistoke pistorasiasta.	Peitä uunin pohja kankaalla.

Ylälamppu

1. vaihe Irrota suojalasi kiertämällä sitä.

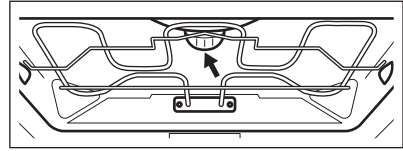

2. vaihe Puhdista suojalasi.

3. vaihe Vaihda lamppu sopivaan 300 °C lämmönkestävään lamppuun.

4. vaihe Kiinnitä suojalasi paikalleen.

11. VIANMÄÄRITYS



VAROITUS!

Lue turvallisuutta koskevat luvut.

11.1 Käyttöhäiriöt

Mikäli laitteessa ilmenevää ongelmaa ei ole kuvattu tässä taulukossa, ota yhteyttä valtuutettuun huoltoliikkeeseen.

Ongelma	Tarkista, että
Uuni ei kuumene.	Sulake on palanut.
Valo ei syty.	Lamppu on palanut.

11.2 Huoltotiedot

Jos ratkaisua ei löydy, ota yhteys jälleenmyyjään taivaltuutettuun huoltopalveluun.

Huoltopalvelun vaatimat tiedot on merkitty arvokilpeen. Arvokilpi sijaitsee uunin sisäosan etukehyksessä. Älä poista arvokilpeä uunista.

Suosittelemme, että kirjoita tiedot tähän:

Malli (MOD.)

Tuotenumero (PNC)

Sarjanumero (S.N.)

12. ENERGIATEHOKKUUS

12.1 Tuotetiedot ja tuotteen tietolomake*

Tavarantoimittajan nimi	AEG
Mallin tunnus	EEB230010M 940321361
Energialuokka	95.3
Energiatehokkuusluokka	A

Energiankulutus normaalikäytössä Ylä- ja alalämpö -toiminnossa	0.99 kWh/ohjelma
Energiankulutus normaalikäytössä Kiertoilma-toiminnossa	0.81 kWh/ohjelma
Pesien lukumäärä	1
Lämpölähde	Sähkö
Tilavuus	71 l
Uunityyppi	Alapuolelle asennettava uuni
Massa	31.5 kg

* Euroopan unionissa EU-määräyksiä 65/2014 ja 66/2014 mukaisesti.
Valko-Venäjän tasavallassa STB 2478-2017:n liitteen G ja STB 2477-2017:n liitteiden A ja B mukaisesti.
Ukrainassa määräyksen 568/32020 mukaisesti.

Energiatohokkuusluokka ei koske Venäjää.

EN 60350-1 - Ruoanlaittoon tarkoitetut sähkötoimiset kodinkoneet - Osa 1: Tuotesarjat, uunit, höyryuunit ja grillit - Suorituskyvyn mittaustavat.

12.2 Energiansäästö



Uunissa on toimintoja, joiden avulla voit säästää energiaa päivittäisessä ruoanlaitossa.

Varmista, että uunin luukku on kiinni uunin ollessa toiminnassa. Älä avaa luukkuja liian usein kypsennyksen aikana. Pidä luukun tiiviste puhtaana ja varmista, että se on hyvin kiinni paikoillaan.

Käytä metallisia keittoastioita energiatohokkuuden parantamiseksi.

Kun mahdollista, älä esikuumenna uunia ennen ruokien asettamista uuniin.

Minimoi paistojen väliset tauot, kun valmistat kerralla useampia ruokia.

Puhallintoiminnon käyttäminen ruoanlaiton yhteydessä

Jos mahdollista, käytä uunitoimintoja puhaltimella energian säästämiseksi.

Jäännöslämpö

Kun kypsennys kestää yli 30 minuuttia, laske uunin lämpötilaa vähintään 3–10 minuuttia ennen kypsennyksen päättymistä. Jälkilämpö uunissa jatkaa ruoka-aineksien kypsentämistä.

Lämmitä muita ruokalajeja jälkilämpöä käyttäen.

Ruoan lämpimänä pitoon

Valitse alhaisin mahdollisin lämpötila-asetus, niin voit hyödyntää jälkilämmön ja säilyttää aterian lämpimänä.

Kostea kiertoilma

Tämä toiminto säästää energiaa ruoanlaiton aikana.

13. YMPÄRISTÖNSUOJELU

Kierrätä materiaalit, jotka on merkitty merkillä



Kierrätä pakkaus laittamalla se asianmukaiseen kierrätysastiaan. Suojele ympäristöä ja ihmisten terveyttä kierrättämällä sähkö- ja elektroniikkaromut.

Älä hävitä merkillä merkittyjä kodinkoneita kotitalousjätteen mukana. Palauta tuote paikalliseen kierrätyskeskukseen tai ota yhteyttä paikalliseen viranomaiseen.

POUR DES RÉSULTATS PARFAITS

Merci d'avoir choisi ce produit AEG. Nous l'avons conçu pour qu'il vous offre des performances irréprochables pendant de nombreuses années, en intégrant des technologies innovantes vous simplifiant la vie – fonctions que vous ne trouverez peut-être pas sur des appareils ordinaires. Veuillez prendre quelques instants pour lire cette notice afin d'utiliser au mieux votre appareil.

Consultez notre site pour :



Obtenir des conseils d'utilisation, des brochures, un dépanneur, des informations sur le service et les réparations :

www.aeg.com/support



Enregistrer votre produit pour un meilleur service :

www.registreaeg.com



Acheter des accessoires, consommables et pièces de rechange d'origine pour votre appareil :

www.aeg.com/shop

SERVICE ET ASSISTANCE À LA CLIENTÈLE

N'utilisez que des pièces de rechange d'origine.

Avant de contacter notre centre de service agréé, assurez-vous de disposer des informations suivantes : Modèle, PNC, numéro de série.

Ces informations figurent sur la plaque signalétique.

 Avertissement/Consignes de sécurité

 Informations générales et conseils

 Informations environnementales

Sous réserve de modifications.

TABLE DES MATIÈRES

1. INFORMATION SUR LA SÉCURITÉ.....	112
2. CONSIGNES DE SÉCURITÉ.....	114
3. DESCRIPTION DE L'APPAREIL.....	117
4. BANDEAU DE COMMANDE.....	118
5. AVANT LA PREMIÈRE UTILISATION.....	119
6. UTILISATION QUOTIDIENNE.....	119
7. UTILISATION DES ACCESSOIRES.....	120
8. FONCTIONS SUPPLÉMENTAIRES.....	121
9. CONSEILS ET ASTUCES.....	121
10. ENTRETIEN ET NETTOYAGE.....	136
11. DÉPANNAGE.....	139
12. RENDEMENT ÉNERGÉTIQUE.....	139

1. INFORMATION SUR LA SÉCURITÉ

Avant d'installer et d'utiliser cet appareil, lisez soigneusement les instructions fournies. Le fabricant ne pourra être tenu pour

responsable des blessures et dégâts résultant d'une mauvaise installation ou utilisation. Conservez toujours les instructions dans un lieu sûr et accessible pour vous y référer ultérieurement.

1.1 Sécurité des enfants et des personnes vulnérables

- Cet appareil peut être utilisé par des enfants âgés d'au moins 8 ans et par des personnes ayant des capacités physiques, sensorielles ou mentales réduites ou dénuées d'expérience ou de connaissance, s'ils sont correctement surveillés ou si des instructions relatives à l'utilisation de l'appareil en toute sécurité leur ont été données et s'ils comprennent les risques encourus. Les enfants de moins de 8 ans et les personnes ayant un handicap très important et complexe doivent être tenus à l'écart de l'appareil, à moins d'être surveillés en permanence.
- Veillez à ce que les enfants ne jouent pas avec l'appareil.
- Ne laissez pas les emballages à la portée des enfants et jetez-les convenablement.
- **AVERTISSEMENT** : tenez les enfants et les animaux éloignés de l'appareil lorsqu'il est en cours de fonctionnement ou lorsqu'il refroidit. Les parties accessibles deviennent chaudes en cours d'utilisation.
- Si l'appareil est équipé d'un dispositif de sécurité enfants, nous vous recommandons de l'activer.
- Le nettoyage et l'entretien par l'utilisateur ne doivent pas être effectués par des enfants sans surveillance.

1.2 Sécurité générale

- Cet appareil doit être installé et le câble remplacé uniquement par un professionnel qualifié.
- N'utilisez pas l'appareil avant de l'avoir installé dans la structure encastrée.
- Débranchez l'appareil de l'alimentation électrique avant toute opération d'entretien.

- Si le câble d'alimentation est endommagé, il doit être remplacé par le fabricant, un service de maintenance agréé ou un technicien qualifié afin d'éviter tout danger lié à l'électricité.
- Le bandeau de commande doit être raccordé à une résistance adaptée en respectant les couleurs des connecteurs pour éviter tout risque.
- Les moyens de déconnexion doivent être incorporés dans le câblage fixé conformément aux réglementations relatives aux câblages.
- **AVERTISSEMENT** : Assurez-vous que l'appareil est éteint et débranché avant de remplacer l'éclairage afin d'éviter tout risque de choc électrique.
- **AVERTISSEMENT** : L'appareil et ses parties accessibles deviennent chauds pendant son fonctionnement. Veillez à ne pas toucher les éléments chauffants.
- Utilisez toujours des gants de cuisine pour retirer ou enfourner des accessoires ou des plats allant au four.
- Pour retirer les supports de grille, tirez d'abord sur l'avant de ceux-ci, puis sur l'arrière, pour les écarter des parois extérieures. Réinstallez les supports de grille en répétant cette procédure dans l'ordre inverse.
- N'utilisez pas de nettoyeur vapeur pour nettoyer l'appareil.
- N'utilisez pas de produits abrasifs ni de racloirs pointus en métal pour nettoyer la porte en verre car ils peuvent rayer sa surface, ce qui peut briser le verre.

2. CONSIGNES DE SÉCURITÉ

2.1 Installation



AVERTISSEMENT!

L'appareil doit être installé uniquement par un professionnel qualifié.

- Retirez l'intégralité de l'emballage.
- N'installez pas et ne branchez pas un appareil endommagé.
- Suivez scrupuleusement les instructions d'installation fournies avec l'appareil.
- Soyez toujours vigilants lorsque vous déplacez l'appareil car il est lourd. Utilisez toujours des gants de sécurité et des chaussures fermées.
- Ne tirez jamais l'appareil par la poignée.
- Installez l'appareil dans un lieu sûr et adapté répondant aux exigences d'installation.
- Les dimensions du meuble de cuisine et de la niche d'encastrement doivent être appropriées.

- Respectez l'espacement minimal requis par rapport aux autres appareils et éléments.
- Avant de monter l'appareil, vérifiez si la porte du four s'ouvre sans retenue.
- Certaines pièces de l'appareil sont électrifiées. Placez l'appareil de façon à éviter que l'on puisse toucher les pièces dangereuses.
- L'appareil est équipé d'un système de refroidissement électrique. Il doit être utilisé avec l'alimentation électrique.
- L'unité intégrée doit répondre aux exigences de stabilité de la norme DIN 68930.

Hauteur minimale du meuble (Hauteur minimale du meuble sous le plan de travail)	578 (600) (mm)
Largeur du meuble	560 (mm)
Profondeur du meuble	550 (550) (mm)
Hauteur de l'avant de l'appareil	594 (mm)
Hauteur de l'arrière de l'appareil	576 (mm)
Largeur de l'avant de l'appareil	595 (mm)
Largeur de l'arrière de l'appareil	559 (mm)
Profondeur de l'appareil	567 (mm)
Profondeur d'encastrement de l'appareil	546 (mm)
Profondeur avec porte ouverte	1027 (mm)
Dimensions minimales de l'ouverture de ventilation. Ouverture placée sur la partie inférieure de la face arrière	560 x 20 (mm)
Vis de montage	4 x 25 (mm)

2.2 Branchement électrique



AVERTISSEMENT!
Risque d'incendie ou d'électrocution.

- Tous les raccordements électriques doivent être effectués par un électricien qualifié.
- L'appareil doit être relié à la terre.
- Assurez-vous que les paramètres figurant sur la plaque signalétique correspondent aux données électriques nominale de l'alimentation secteur.
- Utilisez toujours une prise de courant de sécurité correctement installée.
- N'utilisez pas d'adaptateurs multiprise et de rallonges.
- Veillez à ne pas endommager la fiche secteur ni le câble d'alimentation. Le remplacement du câble d'alimentation de l'appareil doit être effectué par notre service après-vente agréé.
- Ne laissez pas les câbles d'alimentation entrer en contact ou s'approcher de la porte de l'appareil ou de la niche d'encastrement sous l'appareil, particulièrement lorsqu'il est en marche ou que la porte est chaude.
- La protection contre les chocs des parties sous tension et isolées doit être fixée de telle manière qu'elle ne puisse pas être enlevée sans outils.
- Ne branchez la fiche secteur dans la prise secteur qu'à la fin de l'installation. Assurez-vous que la prise secteur est accessible après l'installation.
- Si la prise secteur est détachée, ne branchez pas la fiche secteur.
- Ne tirez pas sur le câble secteur pour débrancher l'appareil. Tirez toujours sur la fiche de la prise secteur.
- N'utilisez que des systèmes d'isolation appropriés : des coupe-circuits, des fusibles (les fusibles à visser doivent être retirés du support), un disjoncteur différentiel et des contacteurs.
- L'installation électrique doit comporter un dispositif d'isolation qui vous permet de déconnecter l'appareil du secteur à tous les pôles. Le dispositif d'isolement doit avoir une largeur d'ouverture de contact de 3 mm minimum.
- Cet appareil est fourni sans fiche électrique ni câble d'alimentation.

2.3 Utilisation



AVERTISSEMENT!

Risque de blessures, de brûlures, d'électrocution ou d'explosion.

- Cet appareil est exclusivement à usage domestique (en intérieur).
- Ne modifiez pas les spécifications de cet appareil.
- Assurez-vous que les orifices d'aération ne sont pas obstrués.
- Ne laissez pas l'appareil sans surveillance durant son fonctionnement.
- Éteignez l'appareil après chaque utilisation.
- Soyez prudent lors de l'ouverture de la porte de l'appareil lorsque celui-ci fonctionne. De l'air chaud peut se dégager.
- N'utilisez pas l'appareil avec des mains mouillées ou en contact avec de l'eau.
- N'exercez pas de pression sur la porte ouverte.
- N'utilisez pas l'appareil comme plan de travail ou comme espace de rangement.
- Ouvrez la porte de l'appareil avec précaution. L'utilisation d'ingrédients avec de l'alcool peut provoquer un mélange d'alcool et d'air.
- Ne laissez pas des étincelles ou des flammes nues entrer en contact avec l'appareil lorsque vous ouvrez la porte.
- Ne placez pas de produits inflammables ou d'éléments imbibés de produits inflammables à l'intérieur, à proximité ou au-dessus de l'appareil.



AVERTISSEMENT!

Risque d'endommagement de l'appareil.

- Pour éviter tout endommagement ou décoloration de l'émail :
 - ne posez pas de plats allant au four ou d'autres objets directement dans le fond de l'appareil.
 - ne placez jamais de feuilles d'aluminium directement sur le fond de la cavité de l'appareil.
 - ne versez pas d'eau directement dans l'appareil chaud.

- ne conservez pas de plats et de nourriture humides dans l'appareil après avoir terminé la cuisson.
- Installez ou retirez les accessoires avec précautions.
- La décoloration de l'émail ou de l'acier inoxydable est sans effet sur les performances de l'appareil.
- Utilisez un plat à rôtir pour des gâteaux moelleux. Les jus de fruits provoquent des taches qui peuvent être permanentes.
- Cet appareil est exclusivement destiné à un usage culinaire. Il ne doit pas être utilisé à d'autres fins, par exemple pour chauffer une pièce.
- Cuisinez toujours avec la porte du four fermée.

2.4 Entretien et Nettoyage



AVERTISSEMENT!

Risque de blessure, d'incendie ou de dommages matériels sur l'appareil.

- Avant toute opération d'entretien, éteignez l'appareil et débranchez la fiche de la prise secteur.
- Vérifiez que l'appareil est froid. Les panneaux de verre risquent de se briser.
- Remplacez immédiatement les vitres de la porte si elles sont endommagées. Contactez le service après-vente agréé.
- Soyez prudent lorsque vous retirez la porte de l'appareil. La porte est lourde !
- Nettoyez régulièrement l'appareil afin de maintenir le revêtement en bon état.
- Nettoyez l'appareil avec un chiffon doux humide. Utilisez uniquement des produits de lavage neutres. N'utilisez pas de produits abrasifs, de tampons à récurer, de solvants ni d'objets métalliques.
- Si vous utilisez un spray pour four, suivez les consignes de sécurité figurant sur son emballage.

2.5 Éclairage intérieur



AVERTISSEMENT!

Risque d'électrocution !

- Concernant la/les lampe(s) à l'intérieur de ce produit et les lampes de rechange vendues séparément : Ces lampes sont

conçues pour résister à des conditions physiques extrêmes dans les appareils électroménagers, telles que la température, les vibrations, l'humidité, ou sont conçues pour signaler des informations sur le statut opérationnel de l'appareil. Elles ne sont pas destinées à être utilisées dans d'autres applications et ne conviennent pas à l'éclairage des pièces d'un logement.

- Utilisez uniquement des ampoules ayant les mêmes spécifications.

2.6 Maintenance

- Pour réparer l'appareil, contactez un service après-vente agréé.
- Utilisez exclusivement des pièces d'origine.

2.7 Mise au rebut



AVERTISSEMENT!

Risque de blessure ou d'asphyxie.

- Contactez votre service municipal pour obtenir des informations sur la marche à suivre pour mettre l'appareil au rebut.
- Débranchez l'appareil de l'alimentation électrique.
- Coupez le câble d'alimentation au ras de l'appareil et mettez-le au rebut.
- Retirez le dispositif de verrouillage du hublot pour empêcher les jeunes et les animaux de s'enfermer dans l'appareil.

3. DESCRIPTION DE L'APPAREIL

3.1 Vue d'ensemble

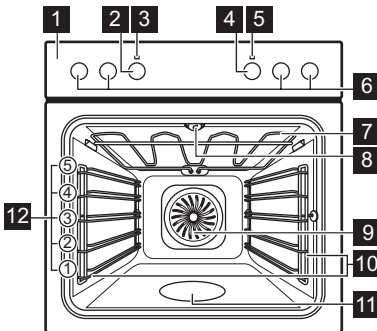

- 1 Bandeau de commande
- 2 Manette de sélection des modes de cuisson
- 3 Voyant / symbole de mise sous tension
- 4 Manette de commande (de la température)
- 5 Indicateur / symbole de température
- 6 Manettes des zones de cuisson
- 7 Résistance
- 8 Éclairage
- 9 Chaleur tournante
- 10 Support de grille, amovible
- 11 Bac de la cavité
- 12 Niveaux de la grille

3.2 Accessoires

Grille métallique

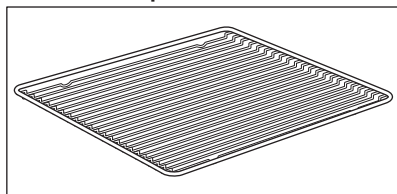

Pour les plats de cuisson, les moules à gâteaux, les rôtis.

Plat multi-usages

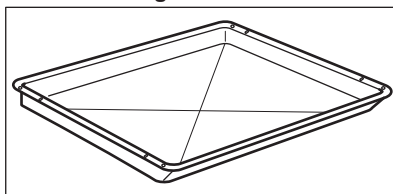

Pour les gâteaux et biscuits. Pour cuire et rôtir ou comme plat pour récupérer la graisse.

4. BANDEAU DE COMMANDE

4.1 Manettes de commande des zones de cuisson

Vous pouvez utiliser la table de cuisson à l'aide des manettes des zones de cuisson.



Vous devez lire le chapitre « Consignes de sécurité » du manuel d'utilisation de la table de cuisson.

4.2 Niveaux de cuisson

Indication de manette	Fonction
0	Position Arrêt
	Fonction Maintien au chaud
1 - 9	Niveaux de cuisson

1. Tournez la manette sur le niveau de cuisson souhaité.
2. Pour terminer le processus de cuisson, tournez la manette de commande sur la position Arrêt.

4.3 Démarrage automatique de la cuisson



Applicable uniquement aux tables de cuisson dotées de la fonction de démarrage automatique de la cuisson.

La fonction de démarrage automatique de la cuisson chauffe la zone de cuisson à pleine puissance pendant un certain temps.

1. Tournez la manette de la zone de cuisson à fond vers la droite (au-delà du niveau de puissance maximal).
2. Réglez immédiatement le niveau de cuisson souhaité.
3. Pour désactiver cette fonction, tournez la manette sur la position Arrêt.

4.4 Utilisation de la double zone (si disponible)



Pour activer la double zone, tournez la manette vers la droite. Ne la tournez pas jusqu'à la position Arrêt.

1. Tournez la manette vers la droite jusqu'à la position 9.
2. Tournez lentement la manette jusqu'à ce que vous entendiez un clic. Les deux zones de cuisson sont activées.
3. Pour ajuster le niveau de puissance nécessaire, reportez-vous au chapitre « Niveaux de cuisson ».

5. AVANT LA PREMIÈRE UTILISATION



AVERTISSEMENT!

Reportez-vous aux chapitres concernant la sécurité.

5.1 Avant la première utilisation

Une odeur et de la fumée peuvent s'échapper du four durant le préchauffage. Assurez-vous que la pièce est ventilée.



Étape 1



Nettoyez le four

1. Retirez les supports de grille amovibles et tous les accessoires du four.
2. Nettoyez le four et les accessoires avec un chiffon doux, de l'eau tiède et un détergent doux.



Étape 2

Préchauffez le four à vide

1. Réglez la température maximale pour la fonction : 
Durée : 1 h.
2. Réglez la température maximale pour la fonction : 
Durée : 15'

Éteignez le four et attendez qu'il soit froid. Placez les accessoires et les supports de grille amovibles dans le four.

6. UTILISATION QUOTIDIENNE



AVERTISSEMENT!

Reportez-vous aux chapitres concernant la sécurité.





6.1 Comment régler : Mode de cuisson





Étape 1 Tournez la manette des modes de cuisson pour sélectionner un mode de cuisson.

Étape 2 Tournez la manette pour sélectionner la température.

Étape 3 Une fois la cuisson terminée, tournez les manettes sur la position Arrêt pour éteindre le four.

6.2 Modes de cuisson

Mode de cuisson	Application
 Position Arrêt	Le four est éteint.
 Éclairage four	Pour allumer l'éclairage.
 Chaleur tournante	Pour faire cuire sur 3 niveaux en même temps et pour sécher des aliments. Diminuez les températures de 20 à 40 °C par rapport à la Chauffage Haut/ Bas.
 Fonction Pizza	Pour cuire des pizzas. Pour faire dorer de façon intensive et obtenir un dessous croustillant.

Mode de cuisson	Application
 Chauffage Haut/ Bas	Pour cuire et rôtir des aliments sur un seul niveau.
 Cuisson de sole	Pour cuire des gâteaux à fond croustillant et pour stériliser des aliments.
 Décongélation	Pour décongeler des aliments (fruits et légumes). Le temps de décongélation dépend de la quantité et de la grosseur des plats surgelés.
 Chaleur tournante humide	Cette fonction est conçue pour économiser de l'énergie en cours de cuisson. Lorsque vous utilisez cette fonction, la température à l'intérieur de la cavité peut différer de la température sélectionnée. La puissance peut être réduite. Pour plus d'informations, consultez la partie sur les remarques du chapitre « Utilisation quotidienne ». Chaleur tournante humide.
 Gril	Pour faire griller des aliments peu épais et du pain.

Mode de cuisson	Application
 Turbo gril	Pour rôtir de gros morceaux de viande ou de volaille avec os sur un seul niveau. Pour gratiner et faire dorer.

 Durant certaines fonctions, l'éclairage s'éteint automatiquement lorsque le four atteint une température inférieure à 60 °C.

6.3 Remarques sur : Chaleur tournante humide

Cette fonction était utilisée pour se conformer à la classe d'efficacité énergétique et aux exigences Ecodesign selon les normes EU 65/2014 et UE 66/2014. Tests conformément à la norme EN 60350-1.

La porte du four doit être fermée pendant la cuisson pour que la fonction ne soit pas interrompue et que le four fonctionne avec la plus grande efficacité énergétique possible.

Pour consulter les instructions de cuisson, reportez-vous au chapitre « Conseils », Chaleur tournante humide. Pour obtenir des recommandations générales sur l'économie d'énergie, reportez-vous au chapitre « Efficacité énergétique », « Économie d'énergie ».

7. UTILISATION DES ACCESSOIRES



AVERTISSEMENT!
Reportez-vous aux chapitres concernant la sécurité.

7.1 Insertion des accessoires

Une petite indentation sur le dessus apporte plus de sécurité. Les indentations sont

également des dispositifs anti-bascule. Le rebord élevé de la grille empêche les ustensiles de cuisine de glisser.

Grille métallique:

Poussez la grille entre les barres de guidage des supports de grille.

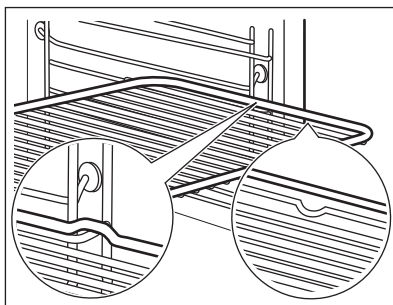
**Lèche-frite:**

Poussez le plateau entre les rails du support de grille.

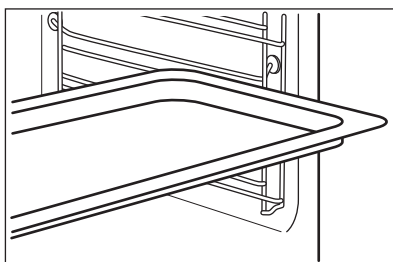
**Grille métallique, Lèche-frite:**

Poussez le plateau entre les rails du support de grille et glissez la grille métallique entre les rails se trouvant juste au-dessus.

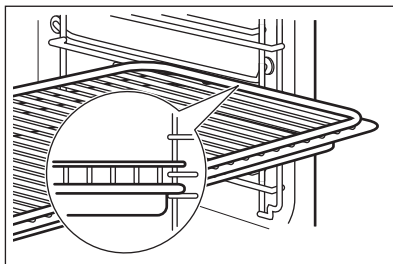

8. FONCTIONS SUPPLÉMENTAIRES

8.1 Ventilateur de refroidissement

Lorsque le four fonctionne, le ventilateur de refroidissement se met automatiquement en marche pour refroidir les surfaces du four. Si

vous éteignez le four, le ventilateur de refroidissement continue à fonctionner jusqu'à ce que le four refroidisse.

9. CONSEILS ET ASTUCES



Reportez-vous aux chapitres concernant la sécurité.

9.1 Exemples d'utilisations de la table de cuisson

Niveau de cuisson	Utilisation	Durée (min)	Conseils
1	Pour maintenir au chaud des plats déjà cuits.	selon les besoins	Placez un couvercle sur le récipient.
1 - 2	Pour faire une sauce hollandaise, faire fondre du beurre, du chocolat, de la gélatine.	5 - 25	Mélangez régulièrement.
1 - 2	Pour solidifier les omelettes et les œufs en cocotte.	10 - 40	Couvrez pendant la cuisson.
2 - 3	Pour cuire à feu doux du riz et des plats à base de lait et réchauffer des plats cuisis.	25 - 50	Ajoutez au moins deux fois plus de liquide que de riz. Remuez les plats à base de lait à mi-cuisson.
3 - 4	Pour cuire à la vapeur des légumes, du poisson et de la viande.	20 - 45	Versez quelques cuillerées à soupe de liquide.
4 - 5	Pour faire cuire des pommes de terre à la vapeur.	20 - 60	Utilisez max. 1/4 l d'eau pour 750 g de pommes de terre.
4 - 5	Pour faire cuire de grosses quantités, des ragoûts et des soupes.	60 - 150	Ajoutez au maximum 3 l de liquide aux ingrédients.
6 - 7	Pour faire cuire à feu doux des escalopes, des cordons bleus de veau, des côtelettes, des rissoles, des saucisses, du foie, des œufs, des crêpes, des beignets et pour faire un roux.	selon les besoins	Retournez à la moitié du temps.
7 - 8	Pour faire frire des pommes de terre sautées, des filets et des steaks.	5 - 15	Retournez à la moitié du temps.
9	Pour faire bouillir de grandes quantités d'eau, faire cuire des pâtes, saisir de la viande (goulasch, bœuf braisé), faire des frites.		

9.2 Recommandations de cuisson



Les températures et temps de cuisson se trouvant dans les tableaux ne sont indiqués qu'à titre indicatif. Ils varient en fonction des recettes ainsi que de la qualité et de la quantité des ingrédients utilisés.

Votre four peut cuire les aliments d'une manière complètement différente de celle de votre ancien four. Les tableaux ci-dessous contiennent les réglages de température, les temps de cuisson et les positions de grilles recommandés pour des types de plats en particulier.

Si vous ne trouvez pas les réglages appropriés pour une recette spécifique, cherchez-en une qui s'en rapproche.

9.3 Cuisson

Pour la première cuisson, utilisez la température inférieure.

Le temps de cuisson peut être prolongé de 10 à 15 minutes, si vous cuisez des gâteaux sur plusieurs niveaux.

Les gâteaux et petites pâtisseries placés à différentes hauteurs ne dorent pas toujours de manière homogène. S'ils ne dorent uniformément, il n'est pas nécessaire de modifier la température. Les différences s'atténuent en cours de cuisson.





Les plateaux insérés dans le four peuvent se déformer en cours de cuisson. Une fois les

plateaux refroidis, les déformations disparaissent.

9.4 Conseils de cuisson

Résultats de cuisson	Cause possible	Solution
Le dessous du gâteau n'est pas suffisamment cuit.	La position de la grille est incorrecte.	Placez le gâteau sur un niveau plus bas.
Le gâteau s'affaisse et devient mou ou plein de grumeaux.	La température du four est trop élevée.	La prochaine fois, réglez une température du four légèrement plus basse.
	Température du four trop élevée et durée de cuisson trop courte.	Réglez une température de cuisson légèrement inférieure et un temps de cuisson plus long la prochaine fois.
Le gâteau est trop sec.	Température de cuisson trop basse.	La prochaine fois, réglez une température du four plus élevée.
	Durée de cuisson trop longue.	La prochaine fois, réduisez le temps de cuisson.
La cuisson du gâteau n'est pas homogène.	Température du four trop élevée et durée de cuisson trop courte.	Réglez une température de cuisson légèrement inférieure et un temps de cuisson plus long la prochaine fois.
	La pâte à gâteau n'est pas correctement répartie.	La prochaine fois, étalez la préparation de façon homogène sur le plateau de cuisson.
Le gâteau n'est pas cuit à la fin de la durée de cuisson indiquée dans la recette.	Température de cuisson trop basse.	La prochaine fois, réglez une température du four légèrement plus élevée.



9.5 Cuisson sur un seul niveau

 CUIS- SON DANS DES MOULES		 (°C)	 (min)	
Fond de tarte - pâte brisée, pré-chauffer le four à vide	Chaleur tournante	170 - 180	10 - 25	2
Fond de tarte - mélange de génoise	Chaleur tournante	150 - 170	20 - 25	2
Savarin / Brioche	Chaleur tournante	150 - 160	50 - 70	1
Quatre-quarts / Gâteaux aux fruits	Chaleur tournante	140 - 160	70 - 90	1
Cheesecake	Chauffage Haut/ Bas	170 - 190	60 - 90	1

Utilisez le troisième niveau de la grille.

Utilisez la fonction : Chaleur tournante.





Utilisez un plateau de cuisson.

 GÂTEAUX / PÂTISSERIES / PAINS	 (°C)	 (min)
Gâteau avec garniture à base de crumble	150 - 160	20 - 40
Flans aux fruits (à base de pâte levée/mélange de génoise), utilisez un plat à rôtir	150	35 - 55
Flans aux fruits à base de pâte brisée	160 - 170	40 - 80





Préchauffez le four à vide.





Utilisez la fonction : Chauffage Haut/ Bas.

Utilisez un plateau de cuisson.

 GÂTEAUX / PÂTISSERIES / PAINS	 (°C)	 (min)	
Gâteau roulé	180 - 200	10 - 20	3
Pain de seigle:	d'abord : 230	20	1
	puis : 160 - 180	30 - 60	
Gâteau aux amandes beurré / Gâteaux au sucre	190 - 210	20 - 30	3
Choux à la crème / Éclairs	190 - 210	20 - 35	3
Pain tressé / Pain en forme de couronne	170 - 190	30 - 40	3
Flans aux fruits (à base de pâte levée/mélange de génoise), utilisez un plat à rôtir	170	35 - 55	3
Gâteaux à pâte levée à garniture fragile (par ex. fromage blanc, crème, crème anglaise)	160 - 180	40 - 80	3
Brioche de Noël	160 - 180	50 - 70	2





Utilisez le troisième niveau de la grille.

 BISCUITS		 (°C)	 (min)
Biscuits à pâte brisée	Chaleur tournante	150 - 160	10 - 20
Petits pains, préchauffer le four à vide	Chaleur tournante	160	10 - 25

 BISCUITS		 (°C)	 (min)
Biscuits à base de mélange de génoise	Chaleur tournante	150 - 160	15 - 20
Pâtes feuilletées, préchauffer le four à vide	Chaleur tournante	170 - 180	20 - 30
Biscuits à base de pâte levée	Chaleur tournante	150 - 160	20 - 40
Macarons	Chaleur tournante	100 - 120	30 - 50
Pâtisseries à base de blanc d'œuf / Meringues	Chaleur tournante	80 - 100	120 - 150
Petits pains, préchauffer le four à vide	Chauffage Haut/ Bas	190 - 210	10 - 25

9.6 Gratins





Utilisez le premier niveau de la grille.

		 (°C)	 (min)
Baguettes nappées de fromage fondu	Chaleur tournante	160 - 170	15 - 30
Gratin de légumes, préchauffer le four à vide	Turbo gril	160 - 170	15 - 30
Lasagne	Chauffage Haut/ Bas	180 - 200	25 - 40
Poisson gratiné	Chauffage Haut/ Bas	180 - 200	30 - 60
Légumes farcis	Chaleur tournante	160 - 170	30 - 60
Pâtisseries sucrées	Chauffage Haut/ Bas	180 - 200	40 - 60
Cuisson des pâtes	Chauffage Haut/ Bas	180 - 200	45 - 60

9.7 Cuisson sur plusieurs niveaux

Utilisez la fonction : Chaleur tournante.

Utilisez les plateaux de cuisson.

 GÂTEAUX / PÂTISSERIES	 (°C)	 (min)	 2 positions
Choux à la crème / Éclairs, préchauffer le four à vide	160 - 180	25 - 45	1 / 4
Gâteau Streusel sec	150 - 160	30 - 45	1 / 4



BIS- CUITS / PETITS GÂTEAUX / VIENNOISE- RIES / ROULÉS



(°C)



(min)



2 positions

3 positions

Petits pains	180	20 - 30	1 / 4	-
Biscuits à pâte brisée	150 - 160	20 - 40	1 / 4	1 / 3 / 5
Biscuits à base de mélange de génoise	160 - 170	25 - 40	1 / 4	-
Pâtes feuilletées, préchauffer le four à vide	170 - 180	30 - 50	1 / 4	-
Biscuits à base de pâte levée	160 - 170	30 - 60	1 / 4	-
Macarons	100 - 120	40 - 80	1 / 4	-
Biscuits à base de blanc d'œuf / Meringues	80 - 100	130 - 170	1 / 4	-

9.8 Conseils de rôtissage

Utilisez des plats résistant à la chaleur.

Viande maigre rôtie couverte (vous pouvez utiliser du papier aluminium).

Vous pouvez cuire de gros rôtis directement dans le plat à rôtir ou sur la grille métallique en plaçant le plat à rôtir en dessous.

Pour éviter que les graisses de cuisson ne brûlent, versez un peu d'eau dans le plat à rôtir.

Si nécessaire, retournez le rôti à la moitié ou aux deux tiers du temps de cuisson.

Faites rôtir la viande et le poisson par morceaux d'au moins 1 kg.

Arrosez les morceaux de viande avec leur propre jus de cuisson plusieurs fois durant la cuisson.

9.9 Rôtissage

Utilisez le premier niveau de la grille.



BŒUF



(°C)



(min)

Braisé	1 - 1,5 kg	Chauffage Haut/ Bas	230	120 - 150
Rôti ou filet de bœuf, saignant, préchauffer le four à vide	par cm d'épaisseur	Turbo gril	190 - 200	5 - 6

 **BŒUF****(°C)****(min)**

Rôti ou filet de bœuf, à point, préchauffer le four à vide

par cm d'épaisseur

Turbo grill

180 - 190

6 - 8

Rôti ou filet de bœuf, bien cuit, préchauffer le four à vide

par cm d'épaisseur

Turbo grill

170 - 180

8 - 10

 **PORC****Utilisez la fonction : Turbo grill.****(kg)****(°C)****(min)**

Épaule / Cou / Noix de jambon

1 - 1.5

160 - 180

90 - 120

Côtelettes / Côte levée

1 - 1.5

170 - 180

60 - 90

Pain de viande

0.75 - 1

160 - 170

50 - 60

Jarret de porc, pré-cuit

0.75 - 1

150 - 170

90 - 120

 **VEAU****Utilisez la fonction : Turbo grill.****(kg)****(°C)****(min)**

Rôti de veau

1

160 - 180

90 - 120

Jarret de veau

1.5 - 2

160 - 180

120 - 150



AGNEAU



Utilisez la fonction : Turbo grill.



(kg)



(°C)



(min)

Gigot d'agneau / Rôti d'agneau

1 - 1.5

150 - 170

100 - 120

Selle d'agneau

1 - 1.5

160 - 180

40 - 60



GIBIER



Utilisez la fonction : Chauffage Haut/ Bas.



(kg)



(°C)



(min)

Selle / Cuisse de lièvre, préchauffer le four à vide

jusqu'à 1

230

30 - 40

Selle de cerf

1.5 - 2

210 - 220

35 - 40

Cuissot de chevreuil

1.5 - 2

180 - 200

60 - 90



VOLAILLE



Utilisez la fonction : Turbo grill.



(kg)



(°C)



(min)

Volaille, portions

0,2 - 0,25 chacun

200 - 220

30 - 50

Poulet, demi

0,4 - 0,5 chacun

190 - 210

35 - 50

Poulet, poularde

1 - 1.5

190 - 210

50 - 70

Canard

1.5 - 2

180 - 200

80 - 100

Oie

3.5 - 5

160 - 180

120 - 180

Dinde

2.5 - 3.5

160 - 180

120 - 150

Dinde

4 - 6

140 - 160

150 - 240



POISSON (À LA VAPEUR)



Utilisez la fonction : Chauffage Haut/ Bas.



(kg)



(°C)



(min)

Poisson entier

1 - 1.5

210 - 220

40 - 60

9.10 Cuisson croustillante avec la fonction : Fonction Pizza



PIZZA



Utilisez le premier niveau de la grille.



(°C)



(min)

Tartes

180 - 200

40 - 55

Flan d'épinards

160 - 180

45 - 60

Quiche lorraine /
Flan suisse

170 - 190

45 - 55

Cheesecake

140 - 160

60 - 90

Tourte aux légumes

160 - 180

50 - 60



PIZZA



Avant la cuisson, faites préchauffer votre four vide.



Utilisez le deuxième niveau de la grille.



(°C)



(min)

Pizza, croûte fine, utilisez un plat à rôtir

200 - 230

15 - 20

Pizza, croûte épaisse

180 - 200

20 - 30

Pain sans levain

230 - 250

10 - 20

Flan à pâte feuilletée

160 - 180

45 - 55

Tarte flambée

230 - 250

12 - 20

Pierogi

180 - 200

15 - 25

9.11 Gril

Avant la cuisson, faites préchauffer votre four vide.

Ne faites griller que des morceaux plats de viande ou de poisson.

Placez un plat au premier niveau pour récupérer les graisses.



GRIL



Utilisez la fonction : Gril



(°C)



(min)

1re face



(min)

2e face



	(°C)	(min) 1re face	(min) 2e face	
Rôti de bœuf	210 - 230	30 - 40	30 - 40	2
Filet de bœuf	230	20 - 30	20 - 30	3
Longe de porc	210 - 230	30 - 40	30 - 40	2
Longe de veau	210 - 230	30 - 40	30 - 40	2
Selle d'agneau	210 - 230	25 - 35	20 - 25	3
Poisson entier, 0,5 kg - 1 kg	210 - 230	15 - 30	15 - 30	3 / 4

9.12 Plats surgelés



DÉCONGÉLATION



Utilisez la fonction : Chaleur tournante.



(°C)



(min)



	(°C)	(min)	
Pizza, surgelée	200 - 220	15 - 25	2
Pizza épaisse, surgelée	190 - 210	20 - 25	2
Pizza, fraîche	210 - 230	13 - 25	2
Bouchées de pizza, surgelées	180 - 200	15 - 30	2
Frites, fines	200 - 220	20 - 30	3
Frites, épaisses	200 - 220	25 - 35	3
Quartiers / Croquettes	220 - 230	20 - 35	3
Rôstis	210 - 230	20 - 30	3
Lasagne / Cannellonis, frais	170 - 190	35 - 45	2
Lasagne / Cannellonis, surgelés	160 - 180	40 - 60	2
Fromage cuit au four	170 - 190	20 - 30	3
Ailes de poulet	190 - 210	20 - 30	2

9.13 Décongélation





Retirez l'emballage des aliments puis placez-les dans une assiette.

Ne couvrez pas les aliments car cela peut rallonger le temps de décongélation.

Pour les grosses quantités d'aliments, placez une assiette vide retournée au fond de la

Utilisez le premier niveau de la grille.

cavité. Placez les aliments dans un plat creux, et posez le tout sur l'assiette retournée dans le four. Retirez les supports de grille si nécessaire.

	 (kg)	 (min) Temps de décongélation	 (min) Temps de décongélation supplémentaire	
Poulet	1	100 - 140	20 - 30	Retournez à la moitié du temps.
Viande	1	100 - 140	20 - 30	Retournez à la moitié du temps.
Truite	0,15	25 - 35	10 - 15	-
Fraises	0,3	30 - 40	10 - 20	-
Beurre	0,25	30 - 40	10 - 15	-
Crème	2 x 0,2	80 - 100	10 - 15	La crème fraîche peut être battue même si elle n'est pas complètement décongelée.
Gâteau	1,4	60	60	-

9.14 Stérilisation

Utilisez la fonction Cuisson de sole.

Utilisez toujours des bocaux à stériliser de dimensions identiques, disponibles dans le commerce.

N'utilisez pas de bocaux à couvercles à visser ou à baïonnette, ni de boîtes métalliques.

Utilisez le premier niveau de la grille.

Ne mettez pas plus de six bocaux à conserves d'un litre sur le plateau de cuisson.

Remplissez les bocaux au même niveau et enclenchez le système de fermeture.

Les bocaux ne doivent pas se toucher.

Mettez environ 1/2 litre d'eau dans le plateau de cuisson pour humidifier le four.

Lorsque le liquide contenu dans les pots commence à frémir (au bout d'environ 35 à 60 minutes pour des pots d'un litre), éteignez le four ou réduisez la température à 100 °C (reportez-vous au tableau).

Réglez la température sur 160 - 170 °C.



BAIES



(min)

Cuisson jusqu'à ce que la préparation commence à frémir

Fraises / Myrtilles / Framboises / Groseilles à maquereau mûres

35 - 45



FRUITS À NOYAU



(min)

Cuisson jusqu'à ce que la préparation commence à frémir



(min)

Continuez la cuisson à 100 °C

Pêches / Coings / Prunes

35 - 45

10 - 15



LÉGUMES



(min)

Cuisson jusqu'à ce que la préparation commence à frémir



(min)

Continuez la cuisson à 100 °C

Carottes

50 - 60

5 - 10

Concombres

50 - 60

-

Cornichons mélangés

50 - 60

5 - 10

Chou-rave / Petits pois / Asperges

50 - 60

15 - 20

9.15 Déshydratation - Chaleur tournante

Couvrez les plateaux avec du papier sulfurisé ou du papier de cuisson.

Pour de meilleurs résultats, arrêtez le four à mi-cuisson, ouvrez la porte et laissez-la refroidir pendant une nuit pour terminer le séchage.

Pour un plateau, utilisez le troisième niveau de la grille.

Pour deux plateaux, utilisez les premier et quatrième niveaux de la grille.



LÉGUMES



(°C)



(h)

Haricots

60 - 70

6 - 8

Poivrons

60 - 70

5 à 6

Légumes pour soupe

60 - 70

5 à 6

Champignons

50 - 60

6 - 8

Herbes

40 - 50

2 à 3

Réglez la température sur 60 - 70 °C.



FRUITS



(h)

Prunes

8 à 10

Abricots

8 à 10

Tranches de pommes

6 - 8

Poires

6 à 9

9.16 Chaleur tournante humide - accessoires recommandés

Utilisez les moules et récipients foncés et non réfléchissants. Ils offrent une meilleure absorption de la chaleur que les plats réfléchissants de couleur claire.



Plaque à pizza

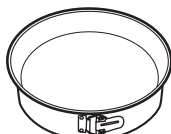

Plat de cuisson



Ramequins



Moule pour fond de tarte

Sombre, non réfléchissant
Diamètre de 28 cm





Sombre, non réfléchissant
Diamètre de 26 cm





Céramique
8 cm de diamètre,
5 cm de hauteur

Sombre, non réfléchissant
Diamètre de 28 cm

9.17 Chaleur tournante humide

Pour de meilleurs résultats, suivez les suggestions indiquées dans le tableau ci-dessous.

		 (°C)		 (min)
Petits pains sucrés, (16 pièces)	Plateau de cuisson ou plat à rôtir	190	3	45 - 55
Pizza, surgelée, 0,35 kg	grille métallique	190	2	45 - 50
Gâteau roulé	Plateau de cuisson ou plat à rôtir	180	2	45 - 55
Brownie	Plateau de cuisson ou plat à rôtir	180	2	55 - 60
Fond de tarte en génoise	moule à tarte sur une grille métallique	180	2	40 - 50
Poisson poché, 0,3 kg	Plateau de cuisson ou plat à rôtir	180	3	25 - 35
Poisson entier, 0,2 kg	Plateau de cuisson ou plat à rôtir	180	3	25 - 35
Filet de poisson, 0,3 kg	plaque à pizza sur la grille métallique	180	3	40 - 50
Viande pochée, 0,25 kg	Plateau de cuisson ou plat à rôtir	190	3	40 - 50
Chachlyk, 0,5 kg	Plateau de cuisson ou plat à rôtir	190	3	35 - 45
Cookies, (16 pièces)	Plateau de cuisson ou plat à rôtir	160	2	40 - 50
Macarons, (24 pièces)	Plateau de cuisson ou plat à rôtir	150	2	35 - 45
Muffins, (12 pièces)	Plateau de cuisson ou plat à rôtir	160	2	35 - 45

		 (°C)		 (min)
Pâtisserie salée, (20 pièces)	Plateau de cuisson ou plat à rôtir	170	2	35 - 45
Biscuits à pâte brisée, (20 pièces)	Plateau de cuisson ou plat à rôtir	150	2	40 - 45
Tartelettes, (8 pièces)	Plateau de cuisson ou plat à rôtir	170	2	35 - 45
Légumes, pochés, 0,4 kg	Plateau de cuisson ou plat à rôtir	180	3	45 - 55
Omelette végétarienne	plaque à pizza sur la grille métallique	190	3	40 - 50

9.18 Informations pour les instituts de test

Tests conformes aux normes : EN 60350, IEC 60350.



CUISSON SUR UN SEUL NIVEAU. Cuisson dans des moules



(°C)

(min)

Génoise allégée	Chaleur tournante	140 - 150	35 - 50	2
Génoise allégée	Chauffage Haut/ Bas	160	35 - 50	2
Tourte aux pommes, 2 moules Ø20 cm	Chaleur tournante	160	60 - 90	2
Tourte aux pommes, 2 moules Ø20 cm	Chauffage Haut/ Bas	180	70 - 90	1



CUISSON SUR UN SEUL NIVEAU. Biscuits/Gâteaux secs



Utilisez le troisième niveau de la grille.



(°C)

(min)

Sablé / Lamelles de pâtisserie	Chaleur tournante	140	25 - 40
--------------------------------	-------------------	-----	---------



CUISSON SUR UN SEUL NIVEAU. Biscuits/Gâteaux secs



Utilisez le troisième niveau de la grille.



(°C)



(min)

Sablé / Lamelles de pâtisserie,
préchauffer le four à vide

Chauffage Haut/ Bas

160

20 - 30

Petits gâteaux, 20 par plateau,
préchauffer le four à vide

Chaleur tournante

150

20 - 35

Petits gâteaux, 20 par plateau,
préchauffer le four à vide

Chauffage Haut/ Bas

170

20 - 30



CUISSON SUR PLUSIEURS NIVEAUX. Biscuits/Gâteaux secs



(°C)



(min)



Sablé / Lamelles de pâtisserie

Chaleur tournante

140

25 - 45

1 / 4

Petits gâteaux, 20 par plateau,
préchauffer le four à vide

Chaleur tournante

150

23 - 40

1 / 4

Génoise allégée

Chaleur tournante

160

35 - 50

1 / 4



GRIL



Préchauffez toujours le four à vide pendant 5 minutes.



Réglez le gril à la température maximale.



(min)



Toasts

Gril

1 - 3

5

Steak de bœuf, tourner à mi-cuis-
son

Gril

24 - 30

4

10. ENTRETIEN ET NETTOYAGE



AVERTISSEMENT!

Reportez-vous aux chapitres concernant la sécurité.

10.1 Remarques concernant l'entretien



Agents nettoyants

Nettoyez la façade du four avec un chiffon doux, de l'eau tiède et un détergent doux.

Utilisez une solution de nettoyage pour nettoyer les surfaces métalliques.

Nettoyez les taches avec un détergent doux.



Utilisation quotidienne

Nettoyez la cavité après chaque utilisation. L'accumulation de graisse ou d'autres résidus peut provoquer un incendie.

Ne conservez pas les aliments dans le four pendant plus de 20 minutes. Sécher la cavité avec un chiffon doux après chaque utilisation.



Accessoires

Après chaque utilisation, lavez tous les accessoires et séchez-les. Utilisez un chiffon doux avec de l'eau tiède et un détergent doux. Ne lavez pas les accessoires au lave-vaisselle.

Ne nettoyez pas les accessoires antiadhésifs avec un produit nettoyant abrasif ou des objets tranchants.

10.2 Comment enlever : Supports de grille

Retirez les supports de grille pour nettoyer le four.

Étape 1 Éteignez le four et attendez qu'il soit froid.

Étape 2 Écartez l'avant du support de grille de la paroi latérale.

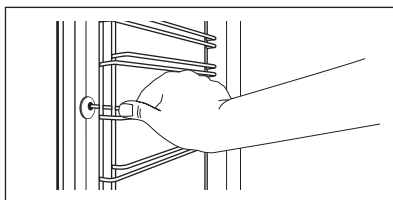

Étape 3 Écartez l'arrière du support de grille de la paroi latérale et retirez le support.

Étape 4 Réinstallez les supports de grille en répétant cette procédure dans l'ordre inverse.

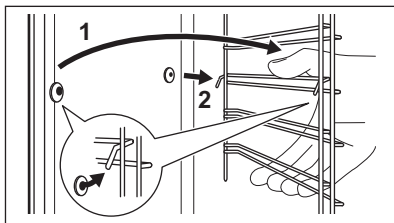

10.3 Comment enlever : Gril



AVERTISSEMENT!
Risque de brûlure !

Étape 1 Éteignez le four et attendez qu'il soit froid pour le nettoyer.
Retirez les supports de grille.

Étape 2 Saisissez les coins de la grille Tirez-la vers l'avant en surmontant la pression du ressort et sortez-la des deux supports. Le gril se replie.

Étape 3 Nettoyez la voûte du four avec de l'eau chaude, un chiffon doux et un détergent doux. Laissez-la sécher.

Étape 4 Installez le gril selon la même procédure, mais dans l'ordre inverse.

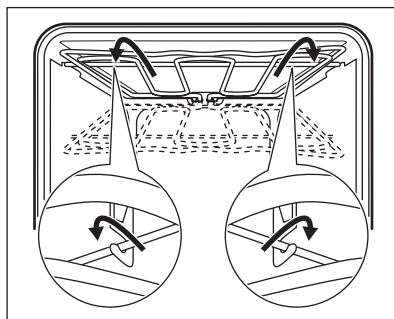

Étape 5 Installez les supports de grille.

10.4 Comment démonter et installer : Porte

Vous pouvez retirer la porte ainsi que les panneaux de verre intérieurs pour les nettoyer. Le nombre de vitres diffère selon les modèles.



AVERTISSEMENT!
La porte est lourde.



ATTENTION!
Manipulez soigneusement la vitre, en particulier autour des bords du panneau avant. Le verre peut se briser.

- Étape 1** Ouvrez entièrement la porte.
- Étape 2** Soulevez et appuyez sur les leviers de blocage (A) sur les deux charnières de la porte.

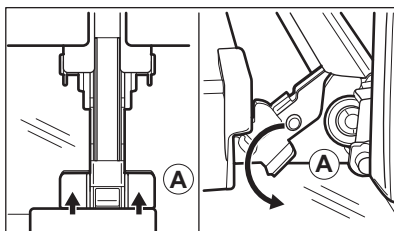

- Étape 3** Fermez la porte du four à la première position (à un angle d'environ 70°). Tenez la porte des deux côtés et retirez-la du four en la soulevant. Posez la porte, face extérieure vers le bas, sur un linge doux posé sur une surface stable.

- Étape 4** Tenez la garniture de porte (B) sur le bord supérieur de la porte des deux côtés et poussez vers l'intérieur pour libérer le joint du clip.

- Étape 5** Retirez le cache de la porte en le tirant vers l'avant.

- Étape 6** Saisissez les panneaux de verre de la porte par leur bord supérieur un par un et dégagez-les du guide.

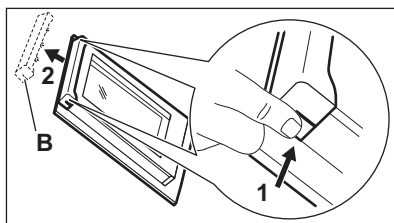

- Étape 7** Nettoyez la vitre à l'eau savonneuse. Essuyez soigneusement la vitre. Ne passez pas les panneaux en verre au lave-vaisselle.

- Étape 8** Après le nettoyage, effectuez les étapes ci-dessus dans le sens inverse.

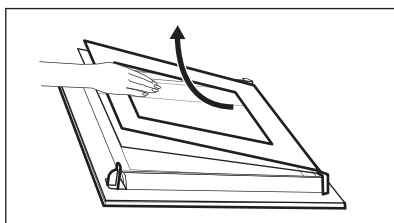

- Étape 9** Installez d'abord le plus petit des panneaux, puis le plus grand, et terminez par la porte. Assurez-vous que les panneaux en verre sont insérés dans la bonne position, car la surface de la porte pourrait surchauffer.

10.5 Comment remplacer : Éclairage



AVERTISSEMENT!
Risque d'électrocution.
L'éclairage peut être chaud.

Avant de remplacer l'éclairage :

Étape 1	Étape 2	Étape 3
Éteignez le four. Attendez que le four ait refroidi.	Débranchez le four de l'alimentation secteur.	Placez un chiffon au fond de la cavité.

Lampe supérieure

- Étape 1** Tournez le diffuseur en verre pour le retirer.

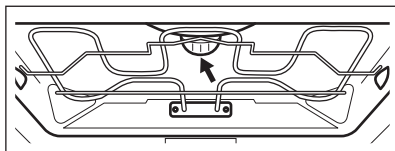

- Étape 2** Nettoyez le diffuseur en verre.

- Étape 3** Remplacez l'éclairage par une ampoule adaptée résistant à une température de 300 °C.

- Étape 4** Remettez en place le diffuseur en verre.

11. DÉPANNAGE



AVERTISSEMENT!

Reportez-vous aux chapitres concernant la sécurité.

11.1 Que faire si...

Dans tous les cas ne figurant pas dans ce tableau, veuillez contacter un service après-vente agréé.

Problème	Vérifiez si...
Le four ne chauffe pas.	Le fusible a disjoncté.
L'éclairage ne fonctionne pas.	L'ampoule est grillée.

11.2 Données de maintenance

Si vous ne trouvez pas de solution au problème, veuillez contacter votre revendeur ou un service après-vente agréé.

Les informations à fournir au service après-vente figurent sur la plaque signalétique. La plaque signalétique se trouve sur l'encadrement avant de la cavité du four. Ne retirez pas la plaque signalétique de la cavité du four.

Nous vous recommandons de noter ces informations ici :

Modèle (MOD.)
Référence du produit (PNC)
Numéro de série (S.N.)

12. RENDEMENT ÉNERGÉTIQUE

12.1 Informations produit et Fiche d'informations produit*

Nom du fournisseur	AEG
Identification du modèle	EEB230010M 940321361
Index d'efficacité énergétique	95.3

Classe d'efficacité énergétique	A
Consommation d'énergie avec charge standard et mode traditionnel	0.99 kWh/cycle
Consommation d'énergie avec charge standard et mode air pulsé	0.81 kWh/cycle
Nombre de cavités	1
Source de chaleur	Électricité
Volume	71 l
Type de four	Four encastrable sous un plan de travail
Masse	31.5 kg

* Pour l'Union européenne conformément aux Règlements UE 65/2014 et 66/2014.
 Pour la République de Biélorussie conformément à STB 2478-2017, Annexe G ; STB 2477-2017, Annexes A et B.
 Pour l'Ukraine conformément à 568/32020.

La classe d'efficacité énergétique n'est pas applicable pour la Russie.

EN 60350-1 - Appareils de cuisson domestiques électriques - Partie 1 : Plages, fours, fours à vapeur et grils - Méthodes de mesure des performances.

12.2 Économie d'énergie



Ce four est doté de caractéristiques qui vous permettent d'économiser de l'énergie lors de votre cuisine au quotidien.

Lorsque le four est en marche, assurez-vous que la porte est bien fermée. Évitez d'ouvrir la porte trop souvent pendant la cuisson. Nettoyez régulièrement le joint de porte et assurez-vous qu'il est bien en place.

Utilisez des plats en métal pour accroître les économies d'énergie.

Dans la mesure du possible, ne préchauffez pas le four avant la cuisson.

Lorsque vous préparez plusieurs plats à la fois, faites en sorte que les pauses entre les cuissons soient aussi courtes que possible.

Cuisson avec ventilation

Si possible, utilisez les fonctions de cuisson avec la ventilation pour économiser de l'énergie.

Chaleur résiduelle

Si la cuisson doit durer plus de 30 minutes, réduisez la température du four au minimum 3 à 10 minutes avant la fin de la cuisson. La chaleur résiduelle à l'intérieur du four poursuivra la cuisson.

Utilisez la chaleur résiduelle pour réchauffer d'autres plats.

Maintien des aliments au chaud

Sélectionnez la température la plus basse possible pour utiliser la chaleur résiduelle et maintenir le repas au chaud.

Chaleur tournante humide

Fonction conçue pour économiser de l'énergie en cours de cuisson.

13. EN MATIÈRE DE PROTECTION DE L'ENVIRONNEMENT

Recyclez les matériaux portant le symbole . Déposez les emballages dans les conteneurs prévus à cet effet. Contribuez à la protection de l'environnement et à votre sécurité, recyclez vos produits électriques et électroniques. Ne jetez pas les appareils

portant le symbole  avec les ordures ménagères. Emmenez un tel produit dans votre centre local de recyclage ou contactez vos services municipaux.

FÜR PERFEKTE ERGEBNISSE

Danke, dass Sie sich für dieses AEG Produkt entschieden haben. Wir haben es geschaffen, damit Sie viele Jahre von seiner ausgezeichneten Leistung und den innovativen Technologien, die Ihnen das Leben erleichtern, profitieren können. Es ist mit Funktionen ausgestattet, die in gewöhnlichen Geräten nicht vorhanden sind. Bitte nehmen Sie sich ein paar Minuten Zeit, um das Beste aus ihm herauszuholen.

Besuchen Sie uns auf unserer Website, um:



Anwendungshinweise, Prospekte, Informationen zu Fehlerbehebung, Service und Reparatur zu erhalten:

www.aeg.com/support



Registrieren Sie Ihr Produkt, um einen erstklassigen Service zu erhalten:

www.registreaeg.com



Um Zubehör, Verbrauchsmaterial und Original-Ersatzteile für Ihr Gerät zu kaufen:

www.aeg.com/shop

KUNDENDIENST UND SERVICE

Verwenden Sie immer Original-Ersatzteile.

Halten Sie folgende Angaben bereit, wenn Sie sich an einen autorisierten Kundendienst wenden: Modell, PNC, Seriennummer.

Die Daten finden Sie auf dem Typenschild.

 Warnungs-/Sicherheitshinweise

 Allgemeine Informationen und Empfehlungen

 Informationen zum Umweltschutz

Änderungen vorbehalten.

INHALTSVERZEICHNIS

1. SICHERHEITSHINWEISE.....	142
2. SICHERHEITSANWEISUNGEN.....	145
3. GERÄTEBESCHREIBUNG.....	148
4. BEDIENFELD.....	148
5. VOR DER ERSTEN VERWENDUNG.....	149
6. TÄGLICHER GEBRAUCH.....	150
7. VERWENDUNG DES ZUBEHÖRS.....	151
8. ZUSATZFUNKTIONEN.....	152
9. TIPPS UND HINWEISE.....	152
10. REINIGUNG UND PFLEGE.....	166
11. FEHLERSUCHE.....	169
12. ENERGIEEFFIZIENZ.....	169

1. SICHERHEITSHINWEISE

Lesen Sie vor der Montage und dem Gebrauch des Geräts zuerst die Bedienungsanleitung. Bei Verletzungen oder

Schäden infolge nicht ordnungsgemäßer Montage oder Verwendung übernimmt der Hersteller keine Haftung. Bewahren Sie die Anleitung zum Nachschlagen an einem sicheren und zugänglichen Ort auf.

1.1 Sicherheit von Kindern und schutzbedürftigen Personen

- Das Gerät kann von Kindern ab 8 Jahren und Personen mit eingeschränkten physischen, sensorischen oder geistigen Fähigkeiten oder mit mangelnder Erfahrung/mangelndem Wissen benutzt werden, wenn sie durch eine für ihre Sicherheit zuständige Person beaufsichtigt werden oder von dieser Person Anweisungen erhalten haben, wie das Gerät sicher zu bedienen ist und welche Gefahren bei nicht ordnungsgemäßer Bedienung bestehen. Kinder unter 8 Jahren und Personen mit schweren Behinderungen oder Mehrfachbehinderung sollten vom Gerät ferngehalten werden, wenn sie nicht ständig beaufsichtigt werden.
- Kinder sollten beaufsichtigt werden, um sicherzustellen, dass sie nicht mit dem Gerät.
- Halten Sie sämtliches Verpackungsmaterial von Kindern fern und entsorgen Sie es ordnungsgemäß.
- **WARNUNG:** Halten Sie Kinder und Haustiere von dem Gerät fern, wenn es in Betrieb oder in der Abkühlphase ist. Die zugänglichen Geräteteile werden beim Betrieb sehr heiß.
- Falls Ihr Gerät mit einer Kindersicherung ausgestattet ist, empfehlen wir, diese einzuschalten.
- Kinder dürfen keine Reinigung und Wartung des Geräts ohne Beaufsichtigung durchführen.

1.2 Allgemeine Sicherheit

- Die Montage des Geräts und der Austausch des Kabels muss von einer Fachkraft vorgenommen werden.
- Verwenden Sie das Gerät nicht, bevor es in den Einbauschrank gesetzt wird.

- Vor Wartungsarbeiten ist das Gerät von der elektrischen Stromversorgung zu trennen.
- Wenn das Netzkabel beschädigt ist, muss es vom Hersteller, seinem autorisierten Kundenservice oder einer gleichermaßen qualifizierten Person ausgetauscht werden, um Gefahren durch elektrischen Strom zu vermeiden.
- Zur Vermeidung von möglichen Gefahren muss das Bedienfeld so an den Backofen angeschlossen werden, dass die Farben der Anschlüsse übereinstimmen.
- Gemäß den Verdrahtungsregeln muss bei Festverdrahtung eine Vorrichtung zur Trennung des Gerätes von der Spannungsversorgung vorhanden sein.
- **WARNUNG:** Vergewissern Sie sich, dass das Gerät ausgeschaltet ist, bevor Sie die Lampe austauschen, um einen Stromschlag zu vermeiden.
- **WARNUNG:** Das Gerät und die zugänglichen Geräteteile werden während des Betriebs heiß. Seien Sie vorsichtig und berühren Sie niemals die Heizelemente.
- Verwenden Sie zum Anfassen des Zubehörs und der Töpfe wärmeisolierende Handschuhe.
- Ziehen Sie die Einhängegitter erst vorne und dann hinten von der Seitenwand weg und nehmen Sie sie heraus. Führen Sie zum Einsetzen der Einhängegitter die oben aufgeführten Schritte in umgekehrter Reihenfolge durch.
- Reinigen Sie das Gerät nicht mit einem Dampfstrahlreiniger.
- Benutzen Sie keine scharfe Scheuermittel oder Metallschwämmchen zum Reinigen der Glastür; sie können die Glasfläche verkratzen und zum Zersplittern der Scheibe führen.

2. SICHERHEITSANWEISUNGEN

2.1 Montage



WARNUNG!

Die Montage des Geräts darf nur von einer qualifizierten Fachkraft durchgeführt werden.

- Entfernen Sie das gesamte Verpackungsmaterial.
- Montieren Sie ein beschädigtes Gerät nicht und benutzen Sie es nicht.
- Halten Sie sich an die mitgelieferte Montageanleitung.
- Seien Sie beim Umsetzen des Gerätes vorsichtig, da es sehr schwer ist. Tragen Sie stets Sicherheitshandschuhe und festes Schuhwerk.
- Ziehen Sie das Gerät nicht am Griff.
- Montieren Sie das Gerät an einem sicheren und geeigneten Ort, der den Montageanforderungen entspricht.
- Das Küchenmöbel und die Einbaunische müssen die passenden Abmessungen aufweisen.
- Die Mindestabstände zu anderen Geräten und Küchenmöbeln sind einzuhalten.
- Überprüfen Sie vor der Montage des Gerätes, ob sich die Ofentür ohne Kraftanwendung öffnen lässt.
- Einige Teile des Geräts sind stromführend. Das Küchenmöbel muss auf allen Seiten mit dem Gerät abschließen, um einen Kontakt mit stromführenden Teilen zu vermeiden.
- Das Gerät ist mit einem elektrischen Kühlsystem ausgestattet. Es muss mit der elektrischen Stromversorgung betrieben werden.
- Das Einbaugerät muss die Stabilitätsanforderungen von DIN 68930 erfüllen.

Mindesthöhe des Einbaumöbels (Mindesthöhe des Schanks unter der Arbeitsplatte)	578 (600) mm
--	--------------

Schrankbreite	560 mm
---------------	--------

Schrankschranktiefe	550 (550) mm
---------------------	--------------

Höhe der Gerätevorderseite	594 mm
----------------------------	--------

Höhe der Geräterückseite	576 mm
Breite der Gerätevorderseite	595 mm
Breite der Geräterückseite	559 mm
Gerätetiefe	567 mm
Geräteeinbautiefe	546 mm
Tiefe bei geöffneter Tür	1027 mm
Mindestgröße der Belüftungsöffnung. Öffnung auf der Rückseite unten	560 x 20 mm
Befestigungsschrauben	4 x 25 mm

2.2 Elektrischer Anschluss



WARNUNG!

Brand- und Stromschlaggefahr.

- Alle elektrischen Anschlüsse sind von einem geprüften Elektriker vorzunehmen.
- Das Gerät muss geerdet sein.
- Stellen Sie sicher, dass die Daten auf dem Typenschild mit den elektrischen Nennwerten der Netzspannung übereinstimmen.
- Schließen Sie das Gerät nur an eine ordnungsgemäß installierte Schutzkontaktsteckdose an.
- Verwenden Sie keine Mehrfachsteckdosen oder Verlängerungskabel.
- Achten Sie darauf, Netzstecker und Netzkabel nicht zu beschädigen. Falls das Netzkabel des Geräts ersetzt werden muss, lassen Sie diese Arbeit durch unseren autorisierten Kundendienst durchführen.
- Achten Sie darauf, dass das Netzkabel die Gerätetür oder die Nische unter dem Gerät nicht berührt oder in ihre Nähe gelangt, insbesondere wenn das Gerät eingeschaltet oder die Tür heiß ist.
- Alle Teile, die gegen direktes Berühren schützen, sowie die isolierten Teile müssen so befestigt werden, dass sie nicht ohne Werkzeug entfernt werden können.

- Stecken Sie den Netzstecker erst nach Abschluss der Montage in die Steckdose. Stellen Sie sicher, dass der Netzstecker nach der Montage noch zugänglich ist.
- Falls die Steckdose lose ist, schließen Sie den Netzstecker nicht an.
- Ziehen Sie nicht am Netzkabel, wenn Sie das Gerät von der Stromversorgung trennen möchten. Ziehen Sie stets am Netzstecker.
- Verwenden Sie nur geeignete Trenneinrichtungen: Überlastschalter, Sicherungen (Schraubversicherungen müssen aus dem Halter entfernt werden können), Fehlerstromschutzschalter und Schütze.
- Die elektrische Installation muss eine Trenneinrichtung aufweisen, mit der Sie das Gerät allpolig von der Stromversorgung trennen können. Die Trenneinrichtung muss mit einer Kontaktöffnungsweite von mindestens 3 mm ausgeführt sein.
- Das Gerät wird ohne Netzstecker und Netzkabel geliefert.

2.3 Gebrauch



WARNUNG!

Verletzungs-, Verbrennungs-, Stromschlag- oder Explosionsgefahr.

- Dieses Gerät ist ausschließlich zur Verwendung im Haushalt (in Innenräumen) bestimmt.
- Nehmen Sie keine technischen Änderungen am Gerät vor.
- Vergewissern Sie sich, dass die Lüftungsöffnungen nicht blockiert sind.
- Lassen Sie das Gerät während des Betriebs nicht unbeaufsichtigt.
- Schalten Sie das Gerät nach jedem Gebrauch aus.
- Gehen Sie beim Öffnen der Tür vorsichtig vor, wenn das Gerät in Betrieb ist. Es kann heiße Luft freigesetzt werden.
- Benutzen Sie das Gerät nicht mit nassen Händen oder wenn es mit Wasser Kontakt hat.
- Üben Sie keinen Druck auf die offene Tür aus.
- Verwenden Sie das Gerät nicht als Arbeits- oder Abstellfläche.

- Öffnen Sie die Gerätetür vorsichtig. Die Verwendung von Zutaten mit Alkohol kann eine Mischung aus Alkohol und Luft verursachen.
- Lassen Sie beim Öffnen der Tür keine Funken oder offenen Flammen mit dem Gerät in Kontakt kommen.
- Platzieren Sie keine entflammaren Produkte oder Gegenstände, die mit entflammaren Produkten benetzt sind, im Gerät, auf dem Gerät oder in der Nähe des Geräts.



WARNUNG!

Risiko von Schäden am Gerät.

- Um Beschädigungen und Verfärbungen der Emailbeschichtung zu vermeiden:
 - Stellen Sie feuerfestes Geschirr oder andere Gegenstände nicht direkt auf den Boden des Geräts.
 - Legen Sie keine Alufolie direkt auf den Boden des Garraums.
 - Füllen Sie kein Wasser in das heiße Gerät.
 - Lassen Sie nach Abschluss des Garvorgangs kein feuchtes Geschirr oder feuchte Speisen im Gerät stehen.
 - Gehen Sie beim Herausnehmen oder Einsetzen des Zubehörs sorgfältig vor.
- Verfärbungen der Emaille- oder Edelstahlbeschichtung haben keine Auswirkung auf die Leistung des Geräts.
- Verwenden Sie eine tiefe Pfanne für feuchte Kuchen. Fruchtsäfte verursachen Flecken, die dauerhaft sein können.
- Dieses Gerät ist nur zum Kochen bestimmt. Es darf nicht für andere Zwecke z. B. zum Erwärmen von Räumen verwendet werden.
- Die Backofentür muss beim Betrieb geschlossen sein.

2.4 Reinigung und Pflege



WARNUNG!

Verletzungs-, Brandgefahr sowie Risiko von Schäden am Gerät.

- Schalten Sie das Gerät immer aus und ziehen Sie den Netzstecker aus der Steckdose, bevor Reinigungsarbeiten durchgeführt werden.

- Vergewissern Sie sich, dass das Gerät abgekühlt ist. Es besteht die Gefahr, dass die Glasscheiben brechen.
- Ersetzen Sie die Türglasscheiben umgehend, wenn sie beschädigt sind. Wenden Sie sich an einen autorisierten Kundendienst.
- Gehen Sie beim Aushängen der Tür vorsichtig vor. Die Tür ist schwer!
- Reinigen Sie das Gerät regelmäßig, um eine Verschlechterung des Oberflächenmaterials zu verhindern.
- Reinigen Sie das Geräts mit einem weichen, feuchten Tuch. Verwenden Sie ausschließlich Neutralreiniger. Benutzen Sie keine Scheuermittel, scheuernde Reinigungsschwämmchen, Lösungsmittel oder Metallgegenstände.
- Falls Sie ein Backofenspray verwenden, befolgen Sie die Sicherheitsanweisungen auf seiner Verpackung.

2.5 Innenbeleuchtung



WARNUNG!

Stromschlaggefahr.

- Bezüglich der Lampe(n) in diesem Gerät und separat verkaufter Ersatzlampen: Diese Lampen müssen extremen physikalischen Bedingungen in Haushaltsgeräten standhalten, wie z.B. Temperatur, Vibration, Feuchtigkeit, oder

sollen Informationen über den Betriebszustand des Gerätes anzeigen. Sie sind nicht für den Einsatz in anderen Geräten vorgesehen und nicht für die Raumbeleuchtung geeignet.

- Verwenden Sie nur Lampen mit der gleichen Leistung .

2.6 Service

- Wenden Sie sich zur Reparatur des Geräts an den autorisierten Kundendienst.
- Verwenden Sie ausschließlich Originalersatzteile.

2.7 Entsorgung



WARNUNG!

Verletzungs- und Erstickungsgefahr.

- Informationen zur Entsorgung des Geräts erhalten Sie von Ihrer Gemeindeverwaltung.
- Trennen Sie das Gerät von der Stromversorgung.
- Schneiden Sie das Netzkabel in der Nähe des Geräts ab, und entsorgen Sie es.
- Entfernen Sie das Türschloss, um zu verhindern, dass sich Kinder, oder Haustiere im Gerät einschließen.

3. GERÄTEBESCHREIBUNG

3.1 Allgemeine Übersicht

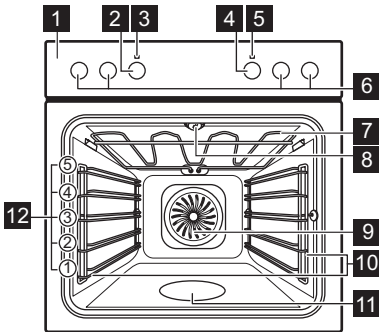

- 1** Bedienfeld
- 2** Einstellknopf für die Ofenfunktionen
- 3** Betriebskontrolllampe/-symbol
- 4** Einstellknopf (für die Temperatur)
- 5** Temperaturanzeige / -symbol
- 6** Kochzonen-Einstellknöpfe
- 7** Heizelement
- 8** Lampe
- 9** Ventilator
- 10** Einschubschienen, herausnehmbar
- 11** Garraumvertiefung
- 12** Einschubebenen

3.2 Zubehör

Kombirost

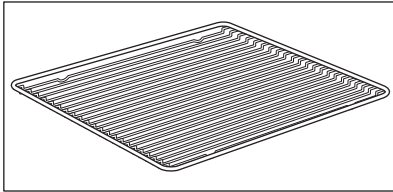

Für Kochgeschirr, Kuchenformen, Braten.

Universalblech

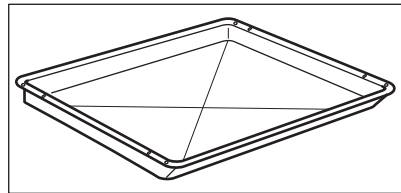

Für Kuchen und Plätzchen. Zum Backen und Braten oder zum Auffangen von abtropfendem Fett.

4. BEDIENFELD

4.1 Kochzonen-Einstellknöpfe

Das Kochfeld kann mit den Kochzonen-Einstellknöpfen bedient werden.



Lesen Sie bitte die Sicherheitshinweise in der Gebrauchsanleitung für das Kochfeld sorgfältig durch.

4.2 Kochstufen

Knopfstellung	Funktion
0	Stellung Aus

Knopfstellung	Funktion
	Warmhaltestufe
1 - 9	Kochstufen

1. Drehen Sie den Einstellknopf auf die gewünschte Kochstufe.
2. Zum Beenden des Kochvorgangs muss der Einstellknopf in die Stellung Aus gedreht werden.

4.3 Ankochautomatik



Nur wenn das Kochfeld mit einer Ankochautomatik ausgestattet ist.

Mit der Ankochautomatik wird die Kochzone eine Zeit lang mit voller Leistung aufgeheizt.

1. Drehen Sie den Kochzonen-Einstellknopf so weit wie möglich im Uhrzeigersinn (über die höchste Kochstufe hinweg).
2. Stellen Sie gleich danach die gewünschte Kochstufe ein.
3. Zum Ausschalten der Funktion muss der Einstellknopf in die Stellung „Aus“ gedreht werden.

4.4 Verwenden der Zweikreis-Kochzone (falls vorhanden)



Drehen Sie den Knopf im Uhrzeigersinn, um die Zweikreis-Kochzone einzuschalten. Drehen Sie ihn jedoch nicht über die Endposition hinaus.

1. Drehen Sie den Knopf im Uhrzeigersinn auf die Stellung 9.
2. Drehen Sie den Knopf langsam, bis er hörbar einrastet. Jetzt sind beide Kochzonen eingeschaltet.
3. Zum Einstellen der gewünschten Kochstufe siehe „Kochstufen“.

5. VOR DER ERSTEN VERWENDUNG



WARNUNG!

Siehe Kapitel Sicherheitshinweise.

5.1 Vor der ersten Inbetriebnahme

Der Backofen kann während des Aufheizens Geruch und Rauch verströmen. Stellen Sie sicher, dass der Raum belüftet ist.



Schritt 1





Schritt 2

Reinigen Sie den Backofen

1. Entfernen Sie alle Zubehörteile und die herausnehmbaren Einhängegitter aus dem Backofen.
2. Feuchten Sie ein weiches Tuch mit warmem Wasser und etwas mildem Reinigungsmittel an, und reinigen Sie damit den Backofen und das Zubehör.

Heizen Sie den leeren Backofen vor

1. Stellen Sie die Höchsttemperatur für folgende Funktion ein: 
Zeit: 1 Std.
2. Stellen Sie die Höchsttemperatur für folgende Funktion ein: 
Zeit: 15 min.

Schalten Sie den Backofen aus und warten Sie, bis er abgekühlt ist. Setzen Sie die Zubehörteile und die herausnehmbaren Einhängegitter in den Backofen.

6. TÄGLICHER GEBRAUCH



WARNUNG!

Siehe Kapitel
Sicherheitshinweise.







6.1 Einstellung: Ofenfunktion

Schritt 1 Drehen Sie den Backofen-Einstellknopf auf eine Ofenfunktion.

Schritt 2 Drehen Sie den Wahlknopf, um die Temperatur auszuwählen.

Schritt 3 Drehen Sie nach Beendigung des Garvorgangs die Knöpfe in die Aus-Position, um den Backofen auszuschalten.

6.2 Ofenfunktionen

Ofenfunktion	Anwendung
 Stellung Aus	Der Backofen ist ausgeschaltet.
 Backofenbeleuchtung	Zum Einschalten der Lampe.
 Heißluft	Zum Backen auf bis zu drei Einschubebenen gleichzeitig und zum Dörren von Lebensmitteln. Stellen Sie eine 20 - 40 °C niedrigere Backofentemperatur als bei Ober-/Unterhitze ein.
 Pizzastufe	Zum Backen von Pizza. Für ein intensives Überbacken und einen knusprigen Boden.
 Ober-/Unterhitze	Zum Backen und Braten von Speisen auf einer Einschubebene.
 Unterhitze	Zum Backen von Kuchen mit knusprigen Böden und zum Einkochen von Lebensmitteln.
 Auftauen	Zum Auftauen von Lebensmitteln (Gemüse und Obst). Die Auftauzeit hängt von der Menge und Größe der gefrorenen Lebensmittel ab.

Ofenfunktion

Anwendung



Feuchte Umluft

Diese Funktion ist entwickelt worden, um während des Kochvorgangs Energie zu sparen. Wenn Sie diese Funktion nutzen, kann die Temperatur im Garraum von der eingestellten Temperatur abweichen. Die Wärmeleistung kann geringer sein. Weitere Informationen zu folgenden Themen finden Sie im Kapitel „Täglicher Gebrauch“: Feuchte Umluft.



Grill

Zum Grillen dünner Lebensmittel und zum Toasten von Brot.



Heißluftgrillen

Zum Braten großer Fleischstücke oder von Geflügel mit Knochen auf einer Ebene. Zum Gratinieren und Überbacken.



Die Lampe wird bei einigen Ofenfunktionen und einer Temperatur unter 60 °C automatisch ausgeschaltet.

6.3 Hinweise zu: Feuchte Umluft

Diese Funktion wurde zur Bestimmung der Energieeffizienzklasse und den Anforderungen an die umweltgerechte Gestaltung EU 65/2014 und EU 66/2014 verwendet. Tests nach EN 60350-1.

Die Backofentür sollte während des Garvorgangs geschlossen bleiben, damit die Funktion nicht unterbrochen wird. So wird gewährleistet, dass der Backofen mit der höchsten Energieeffizienz arbeitet.

Näheres zum Garen finden Sie im Kapitel „Tipps und Hinweise“, Feuchte Umluft. Allgemeine Empfehlungen zum Energiesparen finden Sie im Kapitel „Energieeffizienz“, Energiesparen.

7. VERWENDUNG DES ZUBEHÖRS



WARNUNG!

Siehe Kapitel
Sicherheitshinweise.

dienen auch als Kippsicherung. Durch den umlaufend erhöhten Rand des Rosts ist das Kochgeschirr gegen Abrutschen vom Rost gesichert.

7.1 Einsetzen des Zubehörs

Die kleine Einkerbung auf der Oberseite erhöht die Sicherheit. Diese Einkerbungen

Kombirost:

Schieben Sie den Kombirost zwischen die Führungsschienen der Einhängegitter.

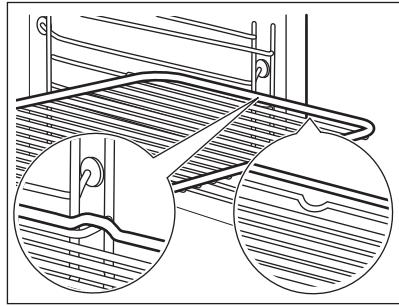

Auflaufpfanne:

Schieben Sie das Blech zwischen die Führungsstäbe der Einhängegitter.

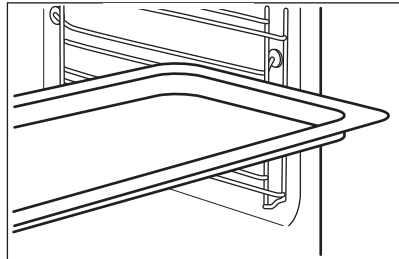

Kombirost, Auflaufpfanne:

Schieben Sie das Backblech zwischen die Führungsstäbe der Einhängegitter und dem Kombirost auf die Führungsstäbe darüber.

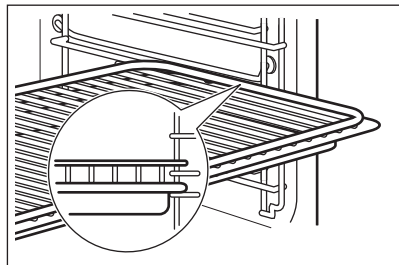

8. ZUSATZFUNKTIONEN

8.1 Kühlgebläse

Wenn der Backofen in Betrieb ist, wird das Kühlgebläse automatisch eingeschaltet, um die Ofenoberflächen zu kühlen. Wenn Sie

den Backofen ausschalten kann das Kühlgebläse weiter laufen, bis der Ofen abgekühlt ist.

9. TIPPS UND HINWEISE



Siehe Kapitel
Sicherheitshinweise.

9.1 Anwendungsbeispiele zum Kochen auf dem Kochfeld

Kochstufe	Anwendung	Dauer (Min.)	Hinweise
1	Warmhalten von bereits zubereiteten Speisen.	Nach Bedarf	Legen Sie einen Deckel auf das Kochgeschirr.
1 - 2	Für Hollandaisesauce, zum Schmelzen von Butter, Schokolade und Gelatine.	5 - 25	Zwischendurch umrühren.
1 - 2	Stocken von lockeren Omeletts und gebackenen Eiern.	10 - 40	Mit Deckel garen.
2 - 3	Köcheln von Reis und Milchgerichten, Erhitzen von Fertiggerichten.	25 - 50	Mindestens die doppelte Menge Flüssigkeit zum Reis geben. Milchgerichte nach der Hälfte der Zeit umrühren.
3 - 4	Dünsten von Gemüse, Fisch und Fleisch.	20 - 45	Einige Esslöffel Flüssigkeit hinzugeben.
4 - 5	Dünsten von Kartoffeln.	20 - 60	Max. ¼ l Wasser für 750 g Kartoffeln verwenden.
4 - 5	Kochen größerer Speisemengen, Eintopfgerichte und Suppen.	60 - 150	Den Zutaten max. 3 l Flüssigkeit hinzufügen.
6 - 7	Schnitzel, Cordon bleu vom Kalb, Kotelett, Frikadellen, Bratwürste, Leber, Eier, Eierkuchen, Krapfen frittieren und Mehlschwitze zubereiten.	Nach Bedarf	Nach der Hälfte der Zeit wenden.
7 - 8	Braten von Rösti, Lendenstücken und Steaks.	5 - 15	Nach der Hälfte der Zeit wenden.
9	Aufkochen großer Mengen Wasser, Nudeln kochen, Anbraten von Fleisch (Gulasch, Schmorbraten) und Frittieren von Pommes frites.		

9.2 Garempfehlungen



Die Temperaturen und Garzeiten in den Tabellen sind nur Richtwerte. Sie sind abhängig von den Rezepten, der Qualität und der Menge der verwendeten Zutaten. Ihr Backofen backt oder brät unter Umständen anders als Ihr früherer Backofen. Die Tabellen unten enthalten die empfohlenen Einstellungen für Temperatur, Gardauer und Einschubebene für die einzelnen Speisen. Finden Sie für ein bestimmtes Rezept keine konkreten Angaben, orientieren Sie sich an einem ähnlichem Rezept.

9.3 Backen

Nutzen Sie, wenn Sie zum ersten Mal backen, die niedrigere Temperatur.

Sie können die Backzeit um 10 - 15 Minuten verlängern, wenn Kuchen auf mehreren Ebenen gebacken werden.

Höhenunterschiede bei Kuchen und Gebäck können zu unterschiedlicher Bräunung





führen. Im Fall einer unterschiedlichen Bräunung ist es nicht notwendig die Temperatur zu ändern. Die Unterschiede gleichen sich während des Backens aus.

Die Backbleche im Ofen können sich beim Backen verformen. Nachdem die Backbleche abgekühlt sind, hebt sich die Verformung wieder auf.

9.4 Backtipps

Backergebnis	Mögliche Ursache	Abhilfe
Die Unterseite des Kuchens ist nicht ausreichend gebacken.	Die Einschubebene ist nicht richtig.	Stellen Sie den Kuchen auf eine tiefere Einschubebene.
Der Kuchen fällt zusammen und ist noch teigig oder mit Wasserstreifen durchzogen.	Die Backofentemperatur ist zu hoch.	Stellen Sie beim nächsten Mal eine niedrigere Backofentemperatur ein.
	Die Backofentemperatur ist zu hoch und die Backzeit zu kurz.	Stellen Sie beim nächsten Mal eine längere Backzeit und eine niedrigere Backofentemperatur ein.
Der Kuchen ist zu trocken.	Die Backofentemperatur ist zu niedrig.	Stellen Sie beim nächsten Mal eine höhere Backofentemperatur ein.
	Die Backzeit ist zu lang.	Stellen Sie beim nächsten Mal eine kürzere Backzeit ein.
Der Kuchen ist unregelmäßig gebräunt.	Die Backofentemperatur ist zu hoch und die Backzeit zu kurz.	Stellen Sie beim nächsten Mal eine längere Backzeit und eine niedrigere Backofentemperatur ein.
	Der Kuchenteig ist nicht gleichmäßig verteilt.	Verteilen Sie beim nächsten Mal den Kuchenteig gleichmäßiger auf dem Backblech.
Der Kuchen ist nach der im Rezept angegebenen Backzeit nicht fertig gebacken.	Die Backofentemperatur ist zu niedrig.	Stellen Sie beim nächsten Mal eine etwas höhere Backofentemperatur ein.



9.5 Backen auf einer Einschubebene

 BA-CKEN IN FOR-MEN		 (°C)	 (Min.)	
Tortenboden aus Mürbeteig, Heizen Sie den leeren Backofen vor	Heißluft	170 - 180	10 - 25	2
Tortenboden aus Rührteig	Heißluft	150 - 170	20 - 25	2
Gugelhupf / Bri- oche	Heißluft	150 - 160	50 - 70	1
Sandkuchen / Früchtekuchen	Heißluft	140 - 160	70 - 90	1
Käsekuchen	Ober-/Unterhitze	170 - 190	60 - 90	1

Nutzen Sie die dritte Einschubebene.

Verwenden Sie die Funktion Heißluft.





Verwenden Sie ein Backblech.





 KUCHEN/GEBÄCK/BROTE	 (°C)	 (Min.)
Streuselkuchen	150 - 160	20 - 40
Obstkuchen (mit Hefeteig/Rührteig), verwenden Sie ein tiefes Blech	150	35 - 55
Obstkuchen mit Mürbeteig	160 - 170	40 - 80

Leeren Backofen vorheizen.





Verwenden Sie die Funktion Ober-/Unterhitze.

Verwenden Sie ein Backblech.

 KUCHEN/ GEBÄCK/BROTE	 (°C)	 (Min.)	
Biskuitrolle	180 - 200	10 - 20	3
Roggenbrot:	erst: 230	20	1
	anschließend: 160 - 180	30 - 60	
Mandelkuchen mit Butter / Zuckerkuchen	190 - 210	20 - 30	3
Windbeutel / Eclairs	190 - 210	20 - 35	3





 KUCHEN/ GEBÄCK/BROTE	 (°C)	 (Min.)	
Hefezopf / Hefekranz	170 - 190	30 - 40	3
Obstkuchen (mit Hefeteig/ Rührteig), verwenden Sie ein tiefes Blech	170	35 - 55	3
Hefekuchen mit empfindli- chen Belägen (z.B. Quark, Sahne, Pudding)	160 - 180	40 - 80	3
Christstollen	160 - 180	50 - 70	2





Nutzen Sie die dritte Einschubebene.

 KLEINGEBÄCK		 (°C)	 (Min.)
Mürbeteig-Plätzchen	Heißluft	150 - 160	10 - 20
Brötchen, Heizen Sie den lee- ren Backofen vor	Heißluft	160	10 - 25
Rührteigplätzchen	Heißluft	150 - 160	15 - 20
Blätterteiggebäck, Heizen Sie den leeren Backofen vor	Heißluft	170 - 180	20 - 30
Hefekleingebäck	Heißluft	150 - 160	20 - 40
Makronen	Heißluft	100 - 120	30 - 50
Gebäck aus Eiweiß / Baiser	Heißluft	80 - 100	120 - 150
Brötchen, Heizen Sie den lee- ren Backofen vor	Ober-/Unterhitze	190 - 210	10 - 25

9.6 Aufläufe und Gratin

Nutzen Sie die erste Einschubebene.





		 (°C)	 (Min.)
Überbackene Baguettes	Heißluft	160 - 170	15 - 30
Gemüsegratin, Heizen Sie den leeren Backofen vor	Heißluftgrillen	160 - 170	15 - 30
Lasagne	Ober-/Unterhitze	180 - 200	25 - 40
Fischaufläufe	Ober-/Unterhitze	180 - 200	30 - 60
Gefülltes Gemüse	Heißluft	160 - 170	30 - 60





		 (°C)	 (Min.)
Süße Aufläufe	Ober-/Unterhitze	180 - 200	40 - 60
Nudelaufauf	Ober-/Unterhitze	180 - 200	45 - 60

9.7 Backen auf mehreren Ebenen

Verwenden Sie die Funktion Heißluft.

Benutzen Sie die Backbleche.

 KUCHEN/ GEBÄCK	 (°C)	 (Min.)	 2 Ebenen
Windbeutel / Eclairs, Heizen Sie den leeren Backofen vor	160 - 180	25 - 45	1 / 4
Streuselkuchen, trocken	150 - 160	30 - 45	1 / 4

 KLEIN- GEBÄCK/KLEI- NE KUCHEN/ GEBÄCK/BRÖT- CHEN	 (°C)	 (Min.)	 2 Ebenen	 3 Ebenen
Brötchen	180	20 - 30	1 / 4	-
Mürbeteig-Plätzchen	150 - 160	20 - 40	1 / 4	1 / 3 / 5
Rührteigplätzchen	160 - 170	25 - 40	1 / 4	-
Blätterteiggebäck, Heizen Sie den leeren Backofen vor	170 - 180	30 - 50	1 / 4	-
Hefekleingebäck	160 - 170	30 - 60	1 / 4	-
Makronen	100 - 120	40 - 80	1 / 4	-
Gebäck aus Eiweiß / Baiser	80 - 100	130 - 170	1 / 4	-

9.8 Tipps zum Braten

Benutzen Sie hitzebeständiges Geschirr.

Braten Sie mageres Fleisch abgedeckt (Sie können Aluminiumfolie verwenden).

Braten Sie große Fleischstücke direkt im Blech oder auf dem Kombirost über dem Blech.

Geben Sie etwas Wasser ins Blech, um zu verhindern, dass das herabtropfende Fett brennt.







Drehen Sie den Braten nach 1/2 - 2/3 der Gardauer.







Braten Sie Fleisch und Fisch in großen Stücken (1 kg oder mehr).

Beträufeln Sie die Fleischstücke mit dem eigenen Saft während des Bratens.

9.9 Braten

Nutzen Sie die erste Einschubebene.

 RINDFLEISCH				 (°C)	 (Min.)
Schmorfleisch		1 - 1,5 kg	Ober-/Unterhitze	230	120 - 150
Roastbeef/Filet, blutig, Heizen Sie den leeren Backofen vor		je cm Dicke	Heißluftgrillen	190 - 200	5 - 6
Roastbeef/Filet, rosa, Heizen Sie den leeren Backofen vor		je cm Dicke	Heißluftgrillen	180 - 190	6 - 8
Roastbeef/Filet, durch, Heizen Sie den leeren Backofen vor		je cm Dicke	Heißluftgrillen	170 - 180	8 - 10

 SCHWEINEFLEISCH		 (kg)	 (°C)	 (Min.)
 Verwenden Sie die Funktion Heißluftgrillen.				
Schulter / Nacken / Schinken- stück		1 - 1.5	160 - 180	90 - 120
Koteletts / Rippchen		1 - 1.5	170 - 180	60 - 90
Hackbraten		0.75 - 1	160 - 170	50 - 60
Schweinsaxe, vorgegart		0.75 - 1	150 - 170	90 - 120



KALB



Verwenden Sie die Funktion Heißluftgrillen.



(kg)



(°C)



(Min.)

Kalbsbraten

1

160 - 180

90 - 120

Kalbschaxe

1.5 - 2

160 - 180

120 - 150



LAMM



Verwenden Sie die Funktion Heißluftgrillen.



(kg)



(°C)



(Min.)

Lammkeule / Lammbraten

1 - 1.5

150 - 170

100 - 120

Lammrücken

1 - 1.5

160 - 180

40 - 60



WILD



Verwenden Sie die Funktion Ober-/Unterhitze.



(kg)



(°C)



(Min.)

Rücken / Hasenkeule, Hei-
zen Sie den leeren Back-
ofen vor

bis zu 1

230

30 - 40

Reh-/Hirschrücken

1.5 - 2

210 - 220

35 - 40

Reh-/Hirscheule

1.5 - 2

180 - 200

60 - 90



GEFLÜGEL



Verwenden Sie die Funktion Heißluftgrillen.



(kg)



(°C)



(Min.)

Geflügelteile	je 0,2 - 0,25	200 - 220	30 - 50
Hähnchen, halbiert	je 0,4 - 0,5	190 - 210	35 - 50
Hähnchen, Poularde	1 - 1.5	190 - 210	50 - 70
Ente	1.5 - 2	180 - 200	80 - 100
Gans	3.5 - 5	160 - 180	120 - 180
Pute	2.5 - 3.5	160 - 180	120 - 150
Pute	4 - 6	140 - 160	150 - 240



FISCH, GEDÄMPFT



Verwenden Sie die Funktion Ober-/Unterhitze.



(kg)



(°C)



(Min.)

Fisch	1 - 1.5	210 - 220	40 - 60
-------	---------	-----------	---------

9.10 Knusprige Backwaren mit Pizzastufe



PIZZA



Nutzen Sie die erste Einschubebene.



(°C)



(Min.)

Obststörtchen	180 - 200	40 - 55
Spinatquiche	160 - 180	45 - 60



PIZZA



Nutzen Sie die erste Einschubebene.



(°C)



(Min.)

Quiche Lorraine / Schweizer Flan	170 - 190	45 - 55
Käsekuchen	140 - 160	60 - 90
Gemüsekuchen	160 - 180	50 - 60



PIZZA



Heizen Sie den leeren Backofen vor dem Garen vor.



Nutzen Sie die zweite Einschubebene.



(°C)



(Min.)

Pizza, dünner Boden, verwenden Sie ein tiefes Blech 200 - 230 15 - 20

Pizza, dicker Boden 180 - 200 20 - 30

Fladenbrot 230 - 250 10 - 20

Blätterteigquiche 160 - 180 45 - 55

Flammkuchen 230 - 250 12 - 20



PIZZA



Heizen Sie den leeren Backofen vor dem Garen vor.



Nutzen Sie die zweite Einschubebene.



(°C)



(Min.)

Piroggen 180 - 200 15 - 25

9.11 Grill

Heizen Sie den leeren Backofen vor dem Garen vor.

Grillen Sie nur dünne Fleisch- oder Fischstücke.

Setzen Sie ein Kuchenblech in die erste Einschubebene, um das Fett aufzufangen.



GRILL



Verwenden Sie die Funktion: Grill



(°C)



(Min.)

Erste Seite



(Min.)

Zweite Seite



Roastbeef 210 - 230 30 - 40

Rinderfilet 230 20 - 30

Schweinelende 210 - 230 30 - 40

Kalbsrücken 210 - 230 30 - 40

Lammrücken 210 - 230 25 - 35

Fisch 0,5 kg - 1 kg 210 - 230 15 - 30

30 - 40

20 - 30

30 - 40

30 - 40

25 - 35

15 - 30

30 - 40

20 - 30

30 - 40

30 - 40

20 - 25

15 - 30

2

3

2

2

3

3 / 4

9.12 Tiefkühlgerichte



AUFTAUEN



Verwenden Sie die Funktion: Heißluft.



(°C)



(Min.)



	(°C)	(Min.)	
Pizza, gefroren	200 - 220	15 - 25	2
Pizza American, gefroren	190 - 210	20 - 25	2
Pizza, gekühlt	210 - 230	13 - 25	2
Pizzasnacks, gefroren	180 - 200	15 - 30	2
Pommes frites, dünn	200 - 220	20 - 30	3
Pommes frites, dick	200 - 220	25 - 35	3
Kartoffelspalten / Kroketten	220 - 230	20 - 35	3
Röstis	210 - 230	20 - 30	3
Lasagne / Cannelloni, frisch	170 - 190	35 - 45	2
Lasagne / Cannelloni, gefroren	160 - 180	40 - 60	2
Gebackener Käse	170 - 190	20 - 30	3
Hähnchenflügel	190 - 210	20 - 30	2

9.13 Auftauen

Nehmen Sie die Lebensmittel aus der Verpackung und legen Sie sie auf einen Teller.

Bedecken Sie die Speise nicht, da dies die Auftauzeit verlängern kann.

Legen Sie bei größeren Nahrungsmittelportionen einen leeren

Nutzen Sie die erste Einschubebene.

umgedrehten Teller auf den Garraumboden. Legen Sie die Speise in eine tiefe Schüssel und stellen Sie sie auf den Teller im Backofen. Entfernen Sie bei Bedarf die Einhängegitter.



(kg)



(Min.)
Auftauzeit



(Min.)
Zusätzliche Auftauzeit







Hähnchen

1

100 – 140

20 – 30

Nach der Hälfte der Gardauer wenden.

	 (kg)	 (Min.) Auftauzeit	 (Min.) Zusätzliche Auf- tauzeit	
Fleisch	1	100 – 140	20 – 30	Nach der Hälfte der Gardauer wenden.
Forelle	0,15	25 – 35	10 – 15	–
Erdbeeren	0,3	30 – 40	10 – 20	–
Butter	0,25	30 – 40	10 – 15	–
Sahne	2 x 0,2	80 – 100	10 – 15	Sahne im leicht gefrorenen Zustand aufschlagen.
Torte	1,4	60	60	–

9.14 Einkochen

Verwenden Sie die Funktion Unterhitze.

Verwenden Sie nur handelsübliche Einmachgläser mit denselben Abmessungen.

Verwenden Sie keine Einmachgläser mit Schraub- und Bajonettdeckeln oder Metalldosen.

Nutzen Sie die erste Einschubebene.

Stellen Sie nicht mehr als sechs Ein-Liter-Einmachgläser auf das Backblech.

Füllen Sie die Einmachgläser gleichmäßig und verschließen Sie sie mit einer Klammer.



Die Einmachgläser dürfen sich nicht berühren.

Geben Sie ungefähr 0,5 l Wasser ins Backblech, um ausreichend Feuchtigkeit im Backofen sicherzustellen.

Wenn die Flüssigkeit in den Einmachgläsern zu köcheln beginnt (nach ungefähr 35-60 Minuten bei 1-l-Einmachgläsern), schalten Sie den Backofen aus oder reduzieren Sie die Temperatur auf 100 °C (siehe Tabelle).



Stellen Sie die Temperatur auf 160 - 170 °C ein.

 BEERENOBST	 (Min.) Gardauer bis zum Köcheln
Erdbeeren / Blaubeeren / Himbeeren / Reife Stachelbeeren	35 - 45

 STEIN-OBST	 (Min.) Gardauer bis zum Köcheln	 (Min.) Kochen Sie weiter bei 100 °C
Pfirsiche / Quit-ten / Pflaumen	35 - 45	10 - 15

 MÜSE	 (Min.) Gardauer bis zum Köcheln	 (Min.) Kochen Sie weiter bei 100 °C
Karotten	50 - 60	5 - 10

Gurken	50 - 60	-
Mixed Pickles	50 - 60	5 - 10

 GE-MÜSE	 (Min.) Gardauer bis zum Köcheln	 (Min.) Kochen Sie weiter bei 100 °C
Kohlrabi / Erbsen / Spargel	50 - 60	15 - 20



9.15 Dörren - Heißluft

Bleche mit fettbeständigem Papier oder Backpapier abdecken.

Um ein besseres Ergebnis zu erzielen, schalten Sie den Backofen nach der Hälfte der Trockenzeit aus, öffnen Sie die Tür und lassen Sie ihn eine Nacht abkühlen, um das Trocknen abzuschließen.

Nutzen Sie für 1 Blech die dritte Einschubebene.

Für 2 Bleche verwenden Sie die erste und vierte Einschubebene.

 GEMÜSE	 (°C)	 (Std.)
Bohnen	60 - 70	6 - 8

9.16 Feuchte Umluft - Empfohlenes Zubehör

Verwenden Sie die dunklen und nicht reflektierenden Formen und Behälter. Sie haben eine bessere Wärmeabsorption als helle Farbe und reflektierende Schüsseln.

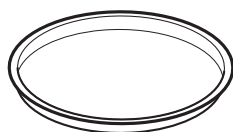

Pizzapfanne

Dunkel, nicht reflektierend
28 cm Durchmesser

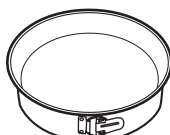

Backform

Dunkel, nicht reflektierend
26 cm Durchmesser



Förmchen

Keramikform
8 cm Durchmesser,
5 cm Höhe





Tortenbodenform



Dunkel, nicht reflektierend
28 cm Durchmesser





9.17 Feuchte Umluft

Beachten Sie für beste Ergebnisse die unten in der Tabelle aufgeführten Empfehlungen.

 GEMÜSE	 (°C)	 (Std.)
Paprika	60 - 70	5 - 6
Suppengemüse	60 - 70	5 - 6
Pilze	50 - 60	6 - 8
Kräuter	40 - 50	2 - 3







Stellen Sie die Temperatur auf 60 - 70 °C ein.

 OBST	 (Std.)
Pflaumen	8 - 10
Aprikosen	8 - 10
Apfelscheiben	6 - 8
Birnen	6 - 9

		 (°C)		 (Min.)
Brötchen, süß, 16 Stück	Backblech oder tiefes Blech	190	3	45 - 55
Pizza, gefroren, 0,35 kg	Kombirost	190	2	45 - 50
Biskuitrolle	Backblech oder tiefes Blech	180	2	45 - 55
Brownie	Backblech oder tiefes Blech	180	2	55 - 60
Biskuitboden	Biskuitform auf Kombirost	180	2	40 - 50
Fisch, pochiert, 0,3 kg	Backblech oder tiefes Blech	180	3	25 - 35
Fisch, 0,2 kg	Backblech oder tiefes Blech	180	3	25 - 35
Fischfilet, 0,3 kg	Pizzapfanne auf Kombirost	180	3	40 - 50
Fleisch, pochiert, 0,25 kg	Backblech oder tiefes Blech	190	3	40 - 50
Schaschlik, 0,5 kg	Backblech oder tiefes Blech	190	3	35 - 45
Plätzchen, 16 Stück	Backblech oder tiefes Blech	160	2	40 - 50
Makronen, 24 Stück	Backblech oder tiefes Blech	150	2	35 - 45
Muffins, 12 Stück	Backblech oder tiefes Blech	160	2	35 - 45
Kleingebäck, pikant, 20 Stück	Backblech oder tiefes Blech	170	2	35 - 45
Mürbeteigplätzchen, 20 Stück	Backblech oder tiefes Blech	150	2	40 - 45
Törtchen, 8 Stück	Backblech oder tiefes Blech	170	2	35 - 45
Gemüse, pochiert, 0,4 kg	Backblech oder tiefes Blech	180	3	45 - 55
Vegetarisches Omelett	Pizzapfanne auf Kombirost	190	3	40 - 50

9.18 Informationen für Prüfinstitute

Tests gemäß EN 60350, IEC 60350.

 BACKEN AUF EINER EINSCHUBELEBENE. Backen in Formen				
		 (°C)	 (Min.)	
Biskuit (fettfrei)	Heißluft	140 - 150	35 - 50	2
Biskuit (fettfrei)	Ober-/Unterhitze	160	35 - 50	2



BACKEN AUF EINER EINSCHUBELENE. Backen in Formen



(°C)



(Min.)



Apfelkuchen, 2 Formen à Ø
20 cm

Heißluft

160

60 - 90

2

Apfelkuchen, 2 Formen à Ø
20 cm

Ober-/Unterhitze

180

70 - 90

1



BACKEN AUF EINER EINSCHUBELENE. Plätzchen



Nutzen Sie die dritte Einschubebene.



(°C)



(Min.)

Mürbeteiggebäck / Feingebäck

Heißluft

140

25 - 40

Mürbeteiggebäck / Feingebäck,
Heizen Sie den leeren Backofen
vor

Ober-/Unterhitze

160

20 - 30

Törtchen, 20 pro Blech, Heizen
Sie den leeren Backofen vor

Heißluft

150

20 - 35

Törtchen, 20 pro Blech, Heizen
Sie den leeren Backofen vor

Ober-/Unterhitze

170

20 - 30



BACKEN AUF MEHREREN EBENEN. Plätzchen



(°C)



(Min.)



Mürbeteiggebäck / Feingebäck

Heißluft

140

25 - 45

1 / 4

Törtchen, 20 pro Blech, Heizen
Sie den leeren Backofen vor

Heißluft

150

23 - 40

1 / 4

Biskuit (fettfrei)

Heißluft

160

35 - 50

1 / 4



Heizen Sie den leeren Backofen 5 Min. vor.



Grillen Sie bei maximaler Temperatureinstellung.



(Min.)



Toast

Grill

1 - 3

5

Rindersteak, Nach der Hälfte der Zeit wenden

Grill

24 - 30

4

10. REINIGUNG UND PFLEGE



WARNUNG!

Siehe Kapitel
Sicherheitshinweise.

10.1 Hinweise zur Reinigung



Reinigungsmittel

Feuchten Sie ein weiches Tuch mit warmem Wasser und etwas mildem Reinigungsmittel an, und reinigen Sie damit die Vorderseite des Backofens.

Reinigen Sie die Metalloberflächen mit einer Reinigungslösung.

Reinigen Sie Flecken mit einem milden Reinigungsmittel.



Täglicher Gebrauch

Reinigen Sie den Garraum nach jedem Gebrauch. Fettansammlungen oder andere Speisereste könnten einen Brand verursachen.

Lassen Sie die Speisen nicht länger als 20 Minuten im Backofen stehen. Trocknen Sie den Garraum nach jedem Gebrauch mit einem weichen Tuch ab.



Zubehör

Reinigen Sie alle Zubehöerteile nach jedem Gebrauch und lassen Sie sie trocknen. Feuchten Sie ein weiches Tuch mit warmem Wasser und einem milden Reinigungsmittel an. Reinigen Sie die Zubehöerteile nicht im Geschirrspüler.

Reinigen Sie das Zubehör mit Antihafbeschichtung nicht mit Scheuermitteln oder scharfkantigen Gegenständen.

10.2 Entfernen: Einhängegitter

Entfernen Sie Einhängegitter zur Reinigung des Backofens.

Schritt 1 Schalten Sie den Backofen aus und warten Sie, bis er abgekühlt ist.

Schritt 2 Ziehen Sie das Einhängegitter vorne von der Seitenwand weg.

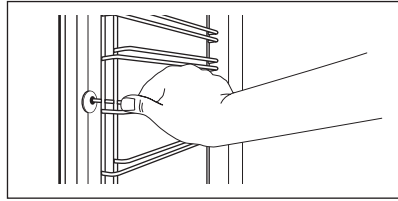

Schritt 3 Ziehen Sie das Einhängegitter hinten von der Seitenwand weg und nehmen Sie es heraus.

Schritt 4 Führen Sie zum Einsetzen der Einhängegitter die oben aufgeführten Schritte in umgekehrter Reihenfolge durch.

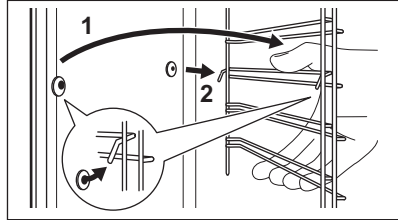

10.3 Entfernen: Grill



WARNUNG!

Es besteht Verbrennungsgefahr.

Schritt 1 Schalten Sie den Backofen aus und warten Sie, bis er abgekühlt ist, um ihn zu reinigen. Entfernen Sie die Einhängegitter.

Schritt 2 Fassen Sie die Ecken des Grills. Ziehen Sie ihn gegen die Federkraft nach vorne und aus beiden Halterungen heraus. Der Grill klappt nach unten.

Schritt 3 Reinigen Sie die Backofendecke mit warmem Wasser, einem weichen Tuch und einem milden Reinigungsmittel. Lassen Sie sie trocknen.

Schritt 4 Führen Sie zum Einsetzen des Grillelements die oben beschriebenen Schritte in umgekehrter Reihenfolge durch.

Schritt 5 Setzen Sie die Einhängegitter wieder ein.

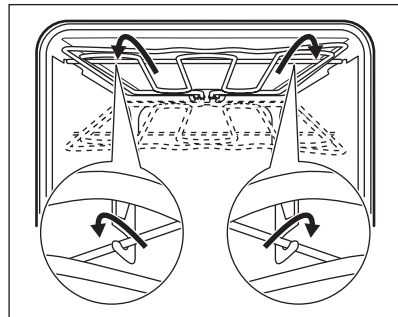

10.4 Aus- und Einbau: Tür

Sie können die Tür und inneren Glasscheiben zur Reinigung entfernen. Die Anzahl der Glasscheiben unterscheidet sich je nach Modell.



WARNUNG!

Die Tür ist schwer.



VORSICHT!

Behandeln Sie das Glas vorsichtig, insbesondere an den Kanten der vorderen Scheibe. Das Glas kann zerbrechen.

Schritt 1 Öffnen Sie die Tür vollständig.

Schritt 2 Heben Sie die Klemmhebel (A) an beiden Türscharnieren an und drücken Sie auf sie.

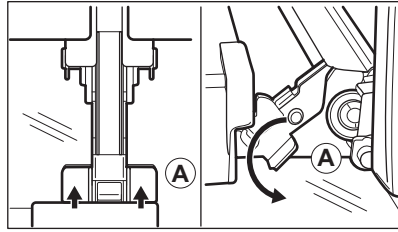

Schritt 3 Schließen Sie die Backofentür bis zur ersten Öffnungsstellung (in einem Winkel von ca. 70°). Fassen Sie die Tür mit beiden Händen seitlich an und ziehen Sie sie schräg nach oben vom Backofen weg. Legen Sie die Tür mit der Außenseite nach unten auf ein weiches Tuch und eine stabile Fläche.

Schritt 4 Fassen Sie die Türabdeckung (B) an der Oberkante der Tür an beiden Seiten an. Drücken Sie sie nach innen, um den Klippverschluss zu lösen.

Schritt 5 Ziehen Sie die Türabdeckung nach vorn, um sie abzunehmen.

Schritt 6 Fassen Sie die Glasscheiben der Tür nacheinander am oberen Rand an und ziehen Sie sie nach oben aus den Führungen.

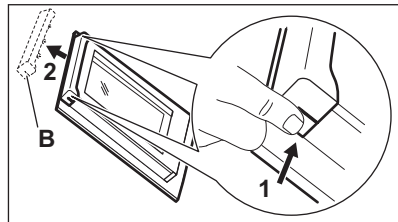

Schritt 7 Reinigen Sie die Glasscheibe mit Wasser und Spülmittel. Trocknen Sie die Glasscheibe sorgfältig ab. Reinigen Sie die Glasscheiben nicht im Geschirrspüler.

Schritt 8 Führen Sie nach der Reinigung die obigen Schritte in umgekehrter Reihenfolge durch.

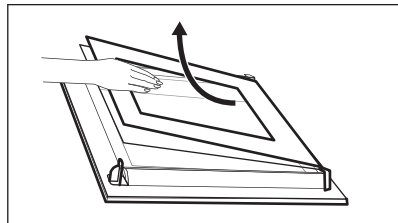

Schritt 9 Setzen Sie zuerst die kleinere Scheibe ein, dann die größere Scheibe und die Tür. Stellen Sie sicher, dass die Glasscheiben in der richtigen Position eingesetzt wurden, da sich andernfalls die Türoberfläche überhitzen kann.

10.5 Austausch: Lampe



WARNUNG!

Stromschlaggefahr.
Die Lampe kann heiß sein.

Bevor Sie die Lampe austauschen:

Schritt 1

Schalten Sie den Backofen aus.
Warten Sie, bis der Ofen kalt ist.

Schritt 2

Trennen Sie den Ofen von der Netzversorgung.

Schritt 3

Breiten Sie ein Tuch auf dem Garraumboden aus.

Obere Lampe

- Schritt 1** Drehen Sie die Glasabdeckung und nehmen Sie sie ab.

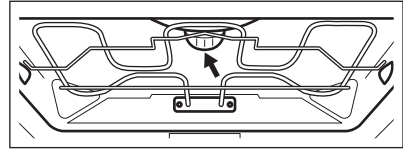

- Schritt 2** Reinigen Sie die Glasabdeckung.

- Schritt 3** Ersetzen Sie die Lampe durch eine geeignete, bis 300 °C hitzebeständige Lampe.

- Schritt 4** Bringen Sie die Glasabdeckung wieder an.

11. FEHLERSUCHE



WARNUNG!

Siehe Kapitel
Sicherheitshinweise.

11.1 Was tun, wenn...

In allen Fällen, die nicht in dieser Tabelle aufgeführt sind, wenden Sie sich bitte an einen autorisierten Kundendienst.

Störung	Prüfen Sie, ob...
Der Backofen nicht heizt.	Die Sicherung durchgebrannt ist.

Störung	Prüfen Sie, ob...
Die Lampe nicht funktioniert.	Die Lampe durchgebrannt ist.

11.2 Servicedaten

Wenn Sie das Problem nicht selbst lösen können, wenden Sie sich an Ihren Händler oder einen autorisierten Kundendienst.

Die vom Kundendienst benötigten Daten finden Sie auf dem Typenschild. Das Typenschild befindet sich am Frontrahmen des Garraums. Entfernen Sie das Typenschild nicht vom Garraum.

Wir empfehlen, hier folgende Daten zu notieren:

Modell (MOD.)

Produktnummer (PNC)

Seriennummer (S.N.)

12. ENERGIEEFFIZIENZ

12.1 Produktinformationen und Produktdatenblatt*

Herstellername	AEG
Modellidentifikation	EEB230010M 940321361
Energieeffizienzindex	95.3

Energieeffizienzklasse	A
Energieverbrauch bei Standardbelastung, Ober-/Unterhitze	0.99 kWh/Programm
Energieverbrauch bei Standardbelastung, Umluft	0.81 kWh/Programm
Anzahl der Garräume	1
Wärmequelle	Strom
Fassungsvermögen	7 l
Backofentyp	Unterbau-Backofen
Gewicht	31.5 kg

* Für die Europäische Union gemäß EU-Richtlinien 65/2014 und 66/2014.

Für die Republik Weißrussland gemäß STB 2478-2017, Anhang G; STB 2477-2017, Anlagen A und B.

Für die Ukraine gemäß 568/32020.

Die Energieeffizienzklasse gilt nicht für Russland.

EN 60350-1 - Elektrische Kochgeräte für den Hausgebrauch - Teil 1: Herde, Backöfen, Dampfgarer und Grillgeräte - Verfahren zur Messung der Gebrauchseigenschaften.

12.2 Energiesparen



Der Backofen verfügt über Funktionen, mit deren Hilfe Sie beim täglichen Kochen Energie sparen können.

Achten Sie darauf, dass die Backofentür während des Ofenbetriebs geschlossen ist. Die Backofentür darf während des Garvorgangs nicht zu oft geöffnet werden. Halten Sie die Türdichtung sauber und stellen Sie sicher, dass sie sich fest in der richtigen Position befindet.

Verwenden Sie Kochgeschirr aus Metall, um mehr Energie zu sparen.

Heizen Sie, wenn möglich, den Backofen nicht vor.

Wenn Sie mehrere Speisen gleichzeitig zubereiten, halten Sie die Unterbrechungen beim Backen so kurz wie möglich.

Garen mit Heißluft

Nutzen Sie, wenn möglich, die Garfunktionen mit Heißluft, um Energie zu sparen.

Restwärme

Beträgt die Garzeit mehr als 30 Minuten, reduzieren Sie die Ofentemperatur 3 - 10 Min. vor Ablauf des Garvorgangs. Die Restwärme im Backofen wird weiterhin garen.

Nutzen Sie die Restwärme, um andere Speisen aufzuwärmen.

Warmhalten von Speisen

Wählen Sie die niedrigste Temperatureinstellung, wenn Sie die Restwärme zum Warmhalten von Speisen nutzen möchten.

Feuchte Umluft

Diese Funktion soll während des Garvorgangs Energie sparen.

13. UMWELTTIPPS

Recyceln Sie Materialien mit dem Symbol . Entsorgen Sie die Verpackung in den entsprechenden Recyclingbehältern. Recyceln Sie zum Umwelt- und Gesundheitsschutz elektrische und

elektronische Geräte. Entsorgen Sie Geräte mit diesem Symbol  nicht mit dem Hausmüll. Bringen Sie das Gerät zu Ihrer örtlichen Sammelstelle oder wenden Sie sich an Ihr Gemeindeamt.

PARA UNOS RESULTADOS PERFECTOS

Gracias por elegir este producto AEG. Lo hemos creado para brindarle un rendimiento impecable durante muchos años, con tecnologías innovadoras que lo ayudan a simplificar la vida, características que quizás no encuentre en los electrodomésticos comunes. Dedique unos minutos a leer este documento para sacarle el máximo partido. **Visite nuestro sitio web para:**



Obtener consejos, folletos, soluciones a problemas e información de servicio y reparación:

www.aeg.com/support



Registrar su producto para recibir un mejor servicio:

www.registreaeg.com



Comprar accesorios, artículos de consumo y piezas de recambio originales para su aparato:

www.aeg.com/shop

ATENCIÓN AL CLIENTE Y SERVICIO

Le recomendamos que utilice recambios originales.

Cuando se ponga en contacto con nuestro Centro de servicio técnico, asegúrese de tener los siguientes datos disponibles: Modelo, código numérico del producto (PNC), número de serie.

La información se encuentra en la placa de características.

 Advertencia / Precaución - Información sobre seguridad

 Información general y consejos

 Información relativa al medioambiente

Salvo modificaciones.

CONTENIDO

1. INFORMACIÓN SOBRE SEGURIDAD.....	171
2. INSTRUCCIONES DE SEGURIDAD.....	173
3. DESCRIPCIÓN DEL PRODUCTO.....	176
4. PANEL DE MANDOS.....	176
5. ANTES DEL PRIMER USO.....	177
6. USO DIARIO.....	178
7. USO DE LOS ACCESORIOS.....	179
8. FUNCIONES ADICIONALES.....	180
9. CONSEJOS.....	180
10. MANTENIMIENTO Y LIMPIEZA.....	194
11. SOLUCIÓN DE PROBLEMAS.....	197
12. EFICACIA ENERGÉTICA.....	198

1. INFORMACIÓN SOBRE SEGURIDAD

Antes de instalar y utilizar el aparato, lea atentamente las instrucciones facilitadas. El fabricante no se hace

responsable de lesiones o daños producidos como resultado de una instalación o un uso incorrectos. Conserve siempre estas instrucciones en lugar seguro y accesible para futuras consultas.

1.1 Seguridad de niños y personas vulnerables

- Este aparato puede ser utilizado por niños de 8 años en adelante y personas cuyas capacidades físicas, sensoriales o mentales estén disminuidas o que carezcan de la experiencia y conocimientos suficientes para manejarlo, siempre que cuenten con las instrucciones o la supervisión sobre el uso del electrodoméstico de forma segura y comprendan los riesgos. Es necesario mantener alejados del aparato a los niños de menos de 8 años, así como a las personas con minusvalías importantes y complejas, salvo que estén bajo supervisión continua.
- Es necesario vigilar a los niños para que no jueguen con el aparato.
- Mantenga todo el material de embalaje fuera del alcance de los niños y deséchelo de forma adecuada.
- **ADVERTENCIA:** Mantenga a los niños y mascotas alejados del aparato cuando esté funcionando o enfriándose. Las piezas accesibles se calientan durante el funcionamiento.
- Si este aparato tiene un bloqueo de seguridad para niños, debe activarlo.
- La limpieza y mantenimiento de usuario del producto no podrán ser realizados por niños sin supervisión.

1.2 Instrucciones generales de seguridad

- Solo un electricista cualificado puede instalar este aparato y sustituir el cable.
- No utilice el aparato antes de instalarlo en la estructura empotrada.
- Desenchufe el aparato de la red eléctrica antes de realizar tareas de mantenimiento.
- Si el cable de alimentación eléctrica sufre algún daño, el fabricante, su servicio técnico autorizado o un profesional

cualificado tendrán que cambiarlo para evitar riesgos eléctricos.

- El panel de control debe conectarse a la unidad especificada haciendo coincidir el color de los conectores para evitar posibles riesgos.
- Los medios de desconexión deben estar incorporados en el cableado fijo de conformidad con las reglas de cableado.
- **ADVERTENCIA:** Asegúrese de que el aparato está desconectado antes de reemplazar la lámpara con el fin de impedir que se produzca una descarga eléctrica.
- **ADVERTENCIA:** El aparato y las piezas accesibles se calientan mucho durante el funcionamiento. Preste mucha atención para no tocar las resistencias.
- Utilice siempre guantes de horno cuando introduzca o retire accesorios o utensilios refractarios.
- Para quitar los carriles laterales, tire primero del frontal del carril y luego separe el extremo trasero de las paredes. Coloque los carriles laterales en el orden inverso.
- No utilice un limpiador a vapor para limpiar el aparato.
- No utilice limpiadores abrasivos ásperos ni rascadores de metal afilado para limpiar la puerta de cristal si no quiere arañar su superficie, lo que podría hacer que el cristal se hiciese añicos.

2. INSTRUCCIONES DE SEGURIDAD

2.1 Instalación



ADVERTENCIA!

Sólo un técnico cualificado puede instalar el aparato.

- Retire todo el embalaje.
- No instale ni utilice un aparato dañado.
- Siga las instrucciones de instalación suministradas con el aparato.
- Tenga cuidado al mover el aparato, porque es pesado. Utilice siempre guantes de protección y calzado cerrado.
- No tire nunca del aparato sujetando el asa.
- Instale el aparato en un lugar seguro y adecuado que cumpla los requisitos de instalación.
- El armario de la cocina y el hueco deben tener las dimensiones adecuadas.
- Respete siempre la distancia mínima entre el aparato y los demás electrodomésticos y mobiliario.
- Antes de montar el aparato, compruebe si la puerta del horno se abre sin limitaciones.
- Algunas partes del aparato tienen corriente. Encajone el aparato en un mueble para evitar tocar las partes peligrosas.

- El aparato está equipado con un sistema de refrigeración eléctrica. Debe utilizarse con la fuente de alimentación eléctrica.
- La unidad empotrada debe cumplir los requisitos de estabilidad de la norma DIN 68930.

Altura mínima del armario (Altura mínima del armario debajo de la encimera)	578 (600) mm
Ancho del armario	560 mm
Profundidad del armario	550 (550) mm
Altura de la parte frontal del aparato	594 mm
Altura de la parte trasera del aparato	576 mm
Anchura de la parte frontal del aparato	595 mm
Anchura de la parte trasera del aparato	559 mm
Fondo del aparato	567 mm
Fondo empotrado del apa- rato	546 mm
Fondo con la puerta abier- ta	1027 mm
Tamaño mínimo de la abertura de ventilación. Abertura situada en la par- te trasera inferior	560 x 20 mm
Tornillos de montaje	4 x 25 mm

2.2 Conexión eléctrica



ADVERTENCIA!

Riesgo de incendios y descargas eléctricas.

- Todas las conexiones eléctricas deben realizarlas electricistas cualificados.
- El aparato debe conectarse a tierra.
- Asegúrese de que los parámetros de la placa de características son compatibles con los valores eléctricos del suministro eléctrico.
- Utilice siempre una toma con aislamiento de conexión a tierra correctamente instalada.
- No utilice adaptadores de enchufes múltiples ni cables prolongadores.

- Asegúrese de no provocar daños en el enchufe ni en el cable de red. Si es necesario cambiar el cable de alimentación del aparato, debe hacerlo el centro de servicio técnico autorizado.
- Evite que el cable de red toque o entre en contacto con la puerta del aparato o con el hueco por debajo del aparato, especialmente mientras funciona o si la puerta está caliente.
- Los mecanismos de protección contra descargas eléctricas de componentes con corriente y aislados deben fijarse de forma que no puedan aflojarse sin utilizar herramientas.
- Conecte el enchufe a la toma de corriente únicamente cuando haya terminado la instalación. Asegúrese de tener acceso al enchufe del suministro de red una vez finalizada la instalación.
- Si la toma de corriente está floja, no conecte el enchufe.
- No desconecte el aparato tirando del cable de conexión a la red. Tire siempre del enchufe.
- Use únicamente dispositivos de aislamiento apropiados: línea con protección contra los cortocircuitos, fusibles (tipo tornillo que puedan retirarse del soporte), dispositivos de fuga a tierra y contactores.
- La instalación eléctrica debe tener un dispositivo de aislamiento que permita desconectar el aparato de todos los polos de la red. El dispositivo de aislamiento debe tener una apertura de contacto con una anchura mínima de 3 mm.
- El aparato se suministra sin enchufe y cable de red.

2.3 Uso



ADVERTENCIA!

Riesgo de lesiones, quemaduras y descargas eléctricas o explosiones.

- Este aparato está diseñado exclusivamente para uso doméstico (en interiores).
- No cambie las especificaciones de este aparato.
- Asegúrese de que las aberturas de ventilación no están bloqueadas.

- No deje el aparato desatendido durante el funcionamiento.
- Apague el aparato después de cada uso.
- Tenga cuidado al abrir la puerta del aparato mientras funciona. Puede liberarse aire caliente.
- No utilice el aparato con las manos mojadas ni con agua en contacto.
- No ejerza presión sobre la puerta abierta.
- No utilice el aparato como superficie de trabajo ni para depositar objetos.
- Abra la puerta del aparato con cuidado. El uso de ingredientes con alcohol puede provocar una mezcla de alcohol y aire.
- No deje que los chispas ni las llamas abiertas entren en contacto con el aparato cuando abra la puerta.
- No coloque productos inflamables o artículos mojados con productos inflamables dentro, cerca o sobre el aparato.



ADVERTENCIA!

Podría dañar el aparato.

- Para evitar daños o decoloraciones en el esmalte:
 - no coloque recipientes ni otros objetos directamente en la base.
 - no coloque papel de aluminio directamente en la parte inferior del interior del aparato.
 - no ponga agua directamente en el aparato caliente.
 - no deje platos húmedos ni alimentos en el aparato una vez finalizada la cocción.
 - tenga cuidado al retirar o instalar los accesorios.
- La pérdida de color del esmalte o el acero inoxidable no afecta al rendimiento del aparato.
- Utilice una bandeja honda para pasteles húmedos. Los jugos de las frutas provocan manchas permanentes.
- Este aparato está diseñado exclusivamente para cocinar. No debe utilizarse para otros tipos de uso, por ejemplo, calentar la habitación.
- Cocine siempre con la puerta cerrada.

2.4 Mantenimiento y limpieza



ADVERTENCIA!

Existe riesgo de lesiones, incendios o daños al aparato.

- Antes de proceder con el mantenimiento, apague el aparato y desconecte el enchufe de la red.
- Asegúrese de que el aparato esté frío. Los paneles de cristal pueden romperse.
- Cambie inmediatamente los paneles de cristal de la puerta que estén dañados. Póngase en contacto con el servicio técnico autorizado.
- Tenga cuidado al desmontar la puerta del aparato. ¡La puerta es muy pesada!
- Limpie periódicamente el aparato para evitar el deterioro del material de la superficie.
- Limpie el aparato con un paño suave humedecido. Utilice solo detergentes neutros. No utilice productos abrasivos, estropajos duros, disolventes ni objetos metálicos.
- Si utiliza aerosoles de limpieza para hornos, siga las instrucciones de seguridad del envase.

2.5 Luces interiores



ADVERTENCIA!

Riesgo de descarga eléctrica.

- En cuanto a la(s) bombilla(s) de este producto y las de repuesto vendidas por separado: Estas bombillas están destinadas a soportar condiciones físicas extremas en los aparatos domésticos, como la temperatura, la vibración, la humedad, o están destinadas a señalar información sobre el estado de funcionamiento del aparato. No están destinadas a utilizarse en otras aplicaciones y no son adecuadas para la iluminación de estancias domésticas.
- Utilice solo bombillas de las mismas características .

2.6 Asistencia

- Para reparar el aparato, póngase en contacto con el centro de servicio autorizado.

- Utilice solamente piezas de recambio originales.

2.7 Eliminación



ADVERTENCIA!

Existe riesgo de lesiones o asfixia.

- Contacte con las autoridades locales para saber cómo desechar correctamente el aparato.
- Desconecte el aparato de la red.
- Corte el cable eléctrico cerca del aparato y deséchelo.
- Retire el pestillo de la puerta para evitar que los niños o las mascotas queden atrapados en el aparato.

3. DESCRIPCIÓN DEL PRODUCTO

3.1 Descripción general

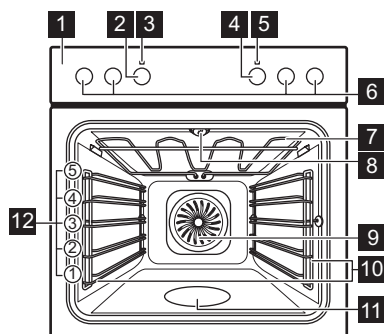

- 1** Panel de mandos
- 2** Mando de las funciones de cocción
- 3** Piloto/símbolo de alimentación
- 4** Mando de control (para la temperatura)
- 5** Indicador/símbolo de temperatura
- 6** Mandos de las zonas de cocción
- 7** Resistencia
- 8** Bombilla
- 9** Ventilador
- 10** Soporte de parrilla extraíble
- 11** Relieve de la cavidad
- 12** Posiciones de las parrillas

3.2 Accesorios

Parrilla

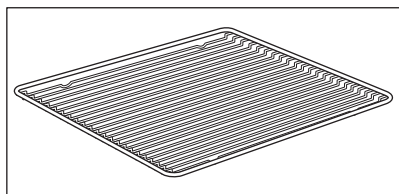

Para utensilios de cocina, moldes de pastelería, asados.

Bandeja combi

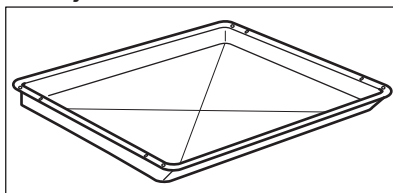

Para bizcochos y galletas. Para hornear y asar o como bandeja para grasa.

4. PANEL DE MANDOS

4.1 Mandos de las zonas de cocción

Puede utilizar la placa con los mandos para las zonas de cocción.



Debe leer los capítulos sobre seguridad del manual del usuario.

4.2 Ajustes de calor

Indicación del mando	Función
0	Posición de apagado
	Mantener caliente
1 - 9	Ajustes de calor

1. Gire el mando hasta el ajuste de calor apropiado.
2. Para terminar el proceso de cocción, gire el mando de control hasta la posición de apagado.

4.3 Calentamiento automático



Solo aplicable a las placas con la función de calentamiento automático.

La función de calentamiento automático aplica la potencia máxima a una zona de cocción durante unos minutos.

1. Gire el mando de la zona de cocción hacia la derecha hasta el tope máximo (más allá del valor de calor más alto).
2. Establezca inmediatamente el ajuste de calor necesario.
3. Para desactivar la función, gire el mando hasta la posición de apagado.

4.4 Uso de la zona de doble circuito (en su caso)



Para activar la zona doble, gire el mando hacia la derecha. No lo gire pasando por la posición de apagado.

1. Gire el mando hacia la derecha hasta la posición 9.
2. Gire el mando lentamente hasta que oiga un clic. Las dos zonas de cocción están encendidas.
3. Para ajustar el valor necesario, consulte "Ajustes de calor".

5. ANTES DEL PRIMER USO



ADVERTENCIA!

Consulte los capítulos sobre seguridad.

5.1 Antes del primer uso

El horno puede emitir olores y humos durante el precalentamiento. Asegúrese de que la sala esté ventilada.



Paso 1



Limpie el horno



Paso 2

Precaliente el horno vacío

1. Retire todos los accesorios y carriles de apoyo extraíbles del horno.
2. Limpie el horno y los accesorios con un paño suave humedecido en agua templada y jabón neutro.

1. Seleccione la temperatura máxima para la función: .
Tiempo: 1 h.
2. Seleccione la temperatura máxima para la función: .
Tiempo: 15 min.

Apague el horno y espere a que esté frío. Coloque los accesorios y carriles de apoyo extraíbles en el horno.

6. USO DIARIO



ADVERTENCIA!

Consulte los capítulos sobre seguridad.

6.1 Cómo configurar: Función de cocción

Paso 1 Gire el mando del horno para seleccionar una función de cocción.

Paso 2 Gire el mando de control para seleccionar la temperatura.

Paso 3 Al terminar la cocción, gire los mandos hasta la posición de apagado para apagar el horno.

6.2 Funciones de cocción

Función de cocción

Aplicación

0

El horno está apagado.

Posición de apagado



Luz

Para encender la luz.



Aire caliente

Para hornear en hasta tres posiciones de parrilla a la vez y para secar alimentos. Ajuste la temperatura entre 20 y 40°C menos que para Cocción convencional.

Función de cocción

Aplicación



Función pizza

Para hornear pizza. Para obtener un dorado más intenso y una base más crujiente.



Cocción convencional

Para hornear y asar alimentos en una posición de parrilla.



Calor inferior

Para hornear pasteles con base crujiente y conservar alimentos.



Descongelar

Para descongelar alimentos (verduras y frutas). El tiempo de descongelación depende de la cantidad y el tamaño de los alimentos congelados.



Horneado húmedo + ventil.

Función diseñada para ahorrar energía durante la cocción. Cuando se utiliza esta función, la temperatura del horno puede diferir de la temperatura programada. La potencia calorífica puede reducirse. Para más información, consulte el capítulo "Uso diario", Notas sobre: Horneado húmedo + ventil. .



Grill

Para asar al grill alimentos de poco espesor y tostar pan.



Grill Turbo

Asado con aire caliente para piezas de carne más grandes o aves con hueso en un nivel. Para gratinar y dorar.



La bombilla se puede desactivar automáticamente a temperaturas inferiores a 60 °C durante algunas funciones del horno.

6.3 Notas sobre: Horneado húmedo + ventil.

Esta función se utilizaba para cumplir con los requisitos de eficiencia energética y diseño

ecológico según EU 65/2014 y EU 66/2014. Pruebas conforme a EN 60350-1.

La puerta del horno debe estar cerrada durante la cocción para que no se interrumpa la función y el horno funcione con la máxima eficiencia energética posible.

Consulte las instrucciones de cocción en el capítulo "Consejos", Horneado húmedo + ventil.. Para recomendaciones generales sobre ahorro energético, consulte el capítulo "Eficiencia energética", ahorro energético.

7. USO DE LOS ACCESORIOS



ADVERTENCIA!

Consulte los capítulos sobre seguridad.

también son dispositivos anti-vuelco. El borde elevado que rodea la bandeja evita que los utensilios de cocina resbalen de la parrilla.

7.1 Inserción de accesorios

Una pequeña muesca en la parte superior aumenta la seguridad. Las hendiduras

Parrilla:

Inserte la parrilla entre las guías del carril .

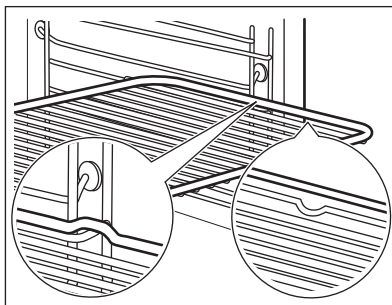

Bandeja honda:

Introduzca la bandeja entre las guías del carril de apoyo.

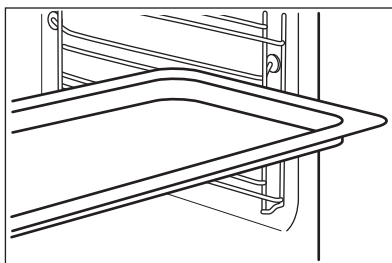

Parrilla, Bandeja honda:

Posicione la bandeja entre las guías del carril de apoyo y la parrilla en las guías de encima.

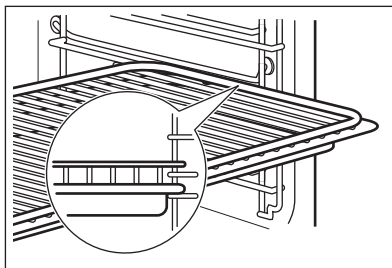

8. FUNCIONES ADICIONALES

8.1 Ventilador de enfriamiento

Cuando el horno funciona, el ventilador de enfriamiento se pone en marcha automáticamente para mantener frías las

superficies del horno. Una vez apagado el horno, el ventilador sigue funcionando hasta enfriarlo totalmente.

9. CONSEJOS



Consulte los capítulos sobre seguridad.

9.1 Ejemplos de aplicaciones de cocción para la placa

Ajuste del nivel de calor	Aplicación	Tiempo (min)	Sugerencias
1	Para mantener calientes los alimentos.	según sea necesario	Tape los utensilios de cocina.
1 - 2	Para preparar salsa holandesa y derretir mantequilla, chocolate y gelatina.	5 - 25	Mezclar a intervalos.
1 - 2	Para cuajar tortilla francesa y huevos revueltos.	10 - 40	Cocinar con tapa.
2 - 3	Para hinchar arroz o platos con leche y calentar platos precocinados.	25 - 50	Añada al menos el doble de líquido que de arroz. Remueva los platos lácteos entremedias.
3 - 4	Para hacer al vapor verduras, pescado y carne.	20 - 45	Añada varias cucharadas de líquido.
4 - 5	Para hacer al vapor patatas.	20 - 60	Utilice como máximo 1/4 l de agua para 750 g de patatas.
4 - 5	Para cocinar grandes cantidades de alimentos, estofados y sopas.	60 - 150	Añada como máximo 3 l de líquido a los ingredientes.

Ajuste del nivel de calor	Aplicación	Tiempo (min)	Sugerencias
6 - 7	Para sofreír escalope, cordon bleu, chuletas, hamburguesas, salchichas, hígado, huevos, tortitas y donuts y para cocinar filetes rusos.	según sea necesario	Dele la vuelta a media cocción.
7 - 8	Para freír bolas de patata, filetes de lomo y filetes.	5 - 15	Dele la vuelta a media cocción.
9	Para hervir grandes cantidades de agua, cocer pasta, dorar carne (gulash, asado) y freír patatas.		

9.2 Recomendaciones de cocción



La temperatura y los tiempos de cocción de las tablas son meramente orientativos. Dependen de la receta, la calidad y la cantidad de los ingredientes utilizados en cada caso. El comportamiento de su horno puede ser diferente al del que tenía anteriormente. Las siguientes tablas muestran los ajustes recomendados para la temperatura, el tiempo de cocción y la posición de los estantes para tipos específicos de alimentos. Si no encuentra los ajustes para una receta especial, busque otra similar.

9.3 Horneado

Para la primera cocción, utilice la temperatura más baja.

El tiempo de cocción puede ampliarse unos 10-15 minutos cuando se hornea repostería en más de una posición.

Los pasteles y las pastas que se hornean a niveles diferentes no siempre se doran de

modo uniforme. No es necesario cambiar el ajuste de temperatura si el tueste no es uniforme. Las diferencias se compensarán durante el horneado.





Las bandejas pueden torcerse en el horno durante el horneado. Las distorsiones desaparecen cuando las bandejas se enfrían de nuevo.

9.4 Consejos para hornear

Resultado	Posible causa	Solución
La base de la tarta no se ha horneado lo suficiente.	La parrilla no está en una posición correcta.	Coloque la tarta en un nivel más bajo.
La tarta se hunde y se queda pegajosa o muestra estrías.	La temperatura del horno es demasiado alta.	La próxima vez ajuste una temperatura del horno ligeramente más baja.
	La temperatura del horno es demasiado alta y el tiempo de cocción demasiado corto.	La próxima vez fije un tiempo de horneado más largo y baje la temperatura del horno.
La tarta está demasiado seca.	La temperatura del horno es demasiado baja.	La próxima vez ajuste una temperatura del horno más alta.
	El tiempo de horneado es demasiado largo.	La próxima vez fije un tiempo de horneado más corto.

Resultado	Posible causa	Solución
El pastel se hornea irregularmente.	La temperatura del horno es demasiado alta y el tiempo de cocción demasiado corto.	La próxima vez fije un tiempo de horneado más largo y baje la temperatura del horno.
	La masa del pastel no se distribuye uniformemente.	La próxima vez, distribuya la masa uniformemente en la bandeja.
El pastel no está listo en el tiempo indicado en la receta.	La temperatura del horno es demasiado baja.	La próxima vez ajuste una temperatura del horno un poco más alta.



9.5 Horneado en un solo nivel

 ALI- MENTOS EN MOLDES		 (°C)	 (min)	
Masa brisé - masa quebrada, precaliente el horno vacío	Aire caliente	170 - 180	10 - 25	2
Masa brisé: bizcocho	Aire caliente	150 - 170	20 - 25	2
Pastel molde redondo / Brioche	Aire caliente	150 - 160	50 - 70	1
Tarta de Madeira / Tarta de frutas	Aire caliente	140 - 160	70 - 90	1
Tarta de queso	Cocción convencional	170 - 190	60 - 90	1

Use el tercer nivel.

Use la función: Aire caliente.





Utilice una bandeja de horno.

 TARTAS / PASTAS / PANES	 (°C)	 (min)
Pastel de azúcar	150 - 160	20 - 40
Tarta de frutas (sobre masa con levadura / bizcocho), utilice una bandeja honda	150	35 - 55
Tarta de fruta sobre masa quebrada	160 - 170	40 - 80





Precaliente el horno vacío.

Use la función: Cocción convencional.

Utilice una bandeja de horno.





 TARTAS / PASTAS / PANES	 (°C)	 (min)	
Brazo de gitano	180 - 200	10 - 20	3
Pan de centeno:	primero: 230	20	1
	después: 160 - 180	30 - 60	
Tarta de almendras y mantequilla / Tartas de azúcar	190 - 210	20 - 30	3
Buñuelos de crema / Bollos rellenos de crema	190 - 210	20 - 35	3
Trenza de pan / Roscón	170 - 190	30 - 40	3
Tarta de frutas (sobre masa con levadura / bizcocho), utilice una bandeja honda	170	35 - 55	3
Bizcochos con levadura coronados de guarniciones delicadas (por ej. requesón, crema, natillas)	160 - 180	40 - 80	3
Pastel de Navidad	160 - 180	50 - 70	2

Use el tercer nivel.

 GALLETAS		 (°C)	 (min)
Galletas de masa quebrada	Aire caliente	150 - 160	10 - 20
Rollitos, precaliente el horno vacío	Aire caliente	160	10 - 25
Galletas de masa batida esponjosa	Aire caliente	150 - 160	15 - 20
Pastas de hojaldre, precaliente el horno vacío	Aire caliente	170 - 180	20 - 30
Galletas de masa de levadura	Aire caliente	150 - 160	20 - 40
Mostachones de almendra	Aire caliente	100 - 120	30 - 50
Galletas de clara de huevo / Merengues	Aire caliente	80 - 100	120 - 150
Rollitos, precaliente el horno vacío	Cocción convencional	190 - 210	10 - 25

9.6 Gratinados y horneados





Use el primer nivel.





		 (°C)	 (min)
Baguetes cubiertas de queso fundido	Aire caliente	160 - 170	15 - 30
Verduras al gratén, precaliéntele el horno vacío	Grill Turbo	160 - 170	15 - 30
Lasaña	Cocción convencional	180 - 200	25 - 40
Pescado al horno	Cocción convencional	180 - 200	30 - 60
Verduras rellenas	Aire caliente	160 - 170	30 - 60
Dulces horneados	Cocción convencional	180 - 200	40 - 60
Gratén de pasta	Cocción convencional	180 - 200	45 - 60

9.7 Horneado en varios niveles

Use la función: Aire caliente.

Utilice las bandejas de horno.

 TARTAS / PASTAS	 (°C)	 (min)	 2 posiciones
Buñuelos de crema / Bollerillos rellenos de crema, precaliéntele el horno vacío	160 - 180	25 - 45	1 / 4
Pastel Streusel seco	150 - 160	30 - 45	1 / 4

 GALLETAS/PASTELLOS/PASTAS/BOLLOS	 (°C)	 (min)	 2 posiciones	 3 posiciones
Rollitos	180	20 - 30	1 / 4	-
Galletas de masa quebrada	150 - 160	20 - 40	1 / 4	1 / 3 / 5
Galletas de masa batida esponjosa	160 - 170	25 - 40	1 / 4	-
Pastas de hojaldre, precaliéntele el horno vacío	170 - 180	30 - 50	1 / 4	-
Galletas de masa de levadura	160 - 170	30 - 60	1 / 4	-
Mostachones de almendra	100 - 120	40 - 80	1 / 4	-



GALLE- TAS/PASTELI- LLOS/PASTAS/ BOLLOS



(°C)



(min)



2 posiciones

3 posiciones

Galletas de clara de
huevo / Merengues

80 - 100

130 - 170

1 / 4

-

9.8 Consejos para asar

Use utensilios para horno resistentes al calor.

Ase la carne magra tapada (puede utilizar papel de aluminio).

Ase los trozos grandes de carne directamente sobre la bandeja o en la parrilla colocada sobre la bandeja.

Para evitar que se queme la grasa, ponga un poco de agua en la bandeja.

Gire el asado al cabo de 1/2 o 2/3 del tiempo de cocción.

Utilice trozos de carne y pescado grandes (1 kg o más).

Durante la cocción, los asados grandes se deben rociar repetidamente con el jugo.

9.9 Asados

Use el primer nivel.



CARNE DE RES



(°C)



(min)

Estofado

1 - 1,5 kg

Cocción convencio-
nal

230

120 - 150

Rosbif o filete, poco he-
cho, precaliente el horno
vacío

por cm de grosor

Grill Turbo

190 - 200

5 - 6

Rosbif o filete, al punto,
precaliente el horno va-
cío

por cm de grosor

Grill Turbo

180 - 190

6 - 8

Rosbif o filete, muy he-
cho, precaliente el horno
vacío

por cm de grosor

Grill Turbo

170 - 180

8 - 10



CERDO



Use la función: Grill Turbo.



(kg)



(°C)



(min)

Paletilla / Cuello / Jamón	1 - 1.5	160 - 180	90 - 120
Chuletas / Costillas	1 - 1.5	170 - 180	60 - 90
Pastel de carne	0.75 - 1	160 - 170	50 - 60
Codillo de cerdo precocinado	0.75 - 1	150 - 170	90 - 120



TERNERA



Use la función: Grill Turbo.



(kg)



(°C)



(min)

Ternera asada	1	160 - 180	90 - 120
Codillo de ternera	1.5 - 2	160 - 180	120 - 150



CORDERO



Use la función: Grill Turbo.



(kg)



(°C)



(min)

Pata de cordero / Cordero asado	1 - 1.5	150 - 170	100 - 120
Silla de cordero	1 - 1.5	160 - 180	40 - 60



CARNE DE CAZA



Use la función: **Cocción convencional.**



(kg)



(°C)



(min)

Silla / Pata de liebre, pre-caliente el horno vacío

hasta 1

230

30 - 40

Silla de corzo

1.5 - 2

210 - 220

35 - 40

Pierna de corzo

1.5 - 2

180 - 200

60 - 90



AVES



Use la función: **Grill Turbo.**



(kg)



(°C)



(min)

Aves troceadas

0,2 - 0,25 cada trozo

200 - 220

30 - 50

Pollo, medio

0,4 - 0,5 cada trozo

190 - 210

35 - 50

Pollo, pularda

1 - 1.5

190 - 210

50 - 70

Pato

1.5 - 2

180 - 200

80 - 100

Ganso

3.5 - 5

160 - 180

120 - 180

Pavo

2.5 - 3.5

160 - 180

120 - 150

Pavo

4 - 6

140 - 160

150 - 240



PESCADO (AL VAPOR)



Use la función: **Cocción convencional.**



(kg)



(°C)



(min)

Pescado entero

1 - 1.5



210 - 220

40 - 60

9.10 Horneado crujiente con: Función pizza

 PIZZA

 Use el primer nivel.



  (°C)  (min)

Tartas	180 - 200	40 - 55
Flan de espinacas	160 - 180	45 - 60
Quiche Lorraine / Flan suizo	170 - 190	45 - 55
Tarta de queso	140 - 160	60 - 90
Pastel de verduras	160 - 180	50 - 60

 PIZZA

 Precaliente el horno vacío antes de cocinar.

 Use el segundo nivel.



  (°C)  (min)

Pizza, base fina, utilice una bandeja honda	200 - 230	15 - 20
---	-----------	---------

 PIZZA

 Precaliente el horno vacío antes de cocinar.

 Use el segundo nivel.

  (°C)  (min)

Pizza, base gruesa	180 - 200	20 - 30
Pan sin levadura	230 - 250	10 - 20
Empanada de masa de hojaldre	160 - 180	45 - 55
Flammkuchen (tarta flambeada)	230 - 250	12 - 20
Pierogi	180 - 200	15 - 25

9.11 Grill

Precaliente el horno vacío antes de cocinar.

Cocine al grill solo trozos de carne o pescado poco gruesos.

Coloque una bandeja en el primer nivel para recoger la grasa.



GRILL



Use la función: Grill



(°C)



(min)
1ª cara



(min)
2ª cara



	(°C)	(min) 1ª cara	(min) 2ª cara	
Redondo al horno	210 - 230	30 - 40	30 - 40	2
Solomillo de res	230	20 - 30	20 - 30	3
Lomo de cerdo	210 - 230	30 - 40	30 - 40	2
Lomo de ternera	210 - 230	30 - 40	30 - 40	2
Silla de cordero	210 - 230	25 - 35	20 - 25	3
Pescado entero, 0,5 kg - 1 kg	210 - 230	15 - 30	15 - 30	3 / 4

9.12 Congelados



DESCONGELACIÓN



Use la función: Aire caliente.



(°C)



(min)



	(°C)	(min)	
Pizza congelada	200 - 220	15 - 25	2
Pizza americana congelada	190 - 210	20 - 25	2
Pizza refrigerada	210 - 230	13 - 25	2
Pizzetas congeladas	180 - 200	15 - 30	2
Patatas fritas finas	200 - 220	20 - 30	3
Patatas fritas gruesas	200 - 220	25 - 35	3
Porciones / Croquetas	220 - 230	20 - 35	3
Patatas asadas con cebolla	210 - 230	20 - 30	3
Lasaña / Canelones frescos	170 - 190	35 - 45	2
Lasaña / Canelones congelados	160 - 180	40 - 60	2
Queso al horno	170 - 190	20 - 30	3
Alitas de pollo	190 - 210	20 - 30	2





9.13 Descongelar

Extraiga el alimento del envase y colóquelo en un plato.

No tape la comida, porque puede prolongar el tiempo de descongelación.

Use el primer nivel.

Para grandes porciones de comida, coloque un plato vacío del revés sobre la base en el interior del horno. Coloque la comida en un plato hondo y sobre el plato del interior del horno. Retire los soportes si es necesario.

	 (kg)	 (min) Tiempo de descongelación	 (min) Tiempo de descongelación adicional	
Pollo	1	100 - 140	20 - 30	Dele la vuelta a media cocción.
carne	1	100 - 140	20 - 30	Dele la vuelta a media cocción.
Trucha	0.15	25 - 35	10 - 15	-
Fresas	0.3	30 - 40	10 - 20	-
Mantequilla	0.25	30 - 40	10 - 15	-
Nata	2 x 0,2	80 - 100	10 - 15	Monte la nata aunque queden puntos ligeramente congelados.
Pasteles	1.4	60	60	-

9.14 Conservar

Use la función Calor inferior.

Utilice únicamente botes de conserva del mismo tamaño disponibles en el mercado.

No utilice botes con cierre hermético (twist-off) o de bayoneta ni latas metálicas.

Use el primer nivel.

No coloque más de seis botes de un litro en la bandeja.

Llene los botes por igual y ciérrelos con una abrazadera.



Los botes no se pueden tocar entre sí.



Ponga aproximadamente 1/2 litro de agua en la bandeja de horno para que haya un grado de humedad suficiente en el horno.



Cuando el líquido de los botes comience a formar burbujas (aprox. después de 35 - 60 minutos con frascos de 1 litro), apague el

horno o reduzca la temperatura a 100 °C (consulte la tabla).

Ajuste la temperatura a 160 - 170 °C.

 FRUTAS SIL-VESTRES	 (min) Cocer hasta que empiecen a subir burbujas
Fresas / Arándanos / Frambuesas / Uvas espina maduras	35 - 45

 FRUTA DE HUESO	 (min) Cocer hasta que empiecen a subir burbujas	 (min) Continuar la cocción a 100 °C
Melocotones / Membrillos / Ciruelas	35 - 45	10 - 15

 VERDURAS DURAS	 (min) Cocer hasta que empiecen a subir burbujas	 (min) Continuar la cocción a 100 °C
Zanahorias	50 - 60	5 - 10
Pepinos	50 - 60	-
Encurtidos variados	50 - 60	5 - 10
Colinabo / Guisantes / Espárragos	50 - 60	15 - 20

9.15 Desecar alimentos - Aire caliente

Cubra las bandejas con papel vegetal o papel de hornear.

9.16 Horneado húmedo + ventil.. accesorios recomendados

Utilice molde y recipientes oscuros y mates. Tiene mejor absorción del calor que los platos de color claro y brillantes.



Bandeja para pizza

Oscuro, mate
28 cm de diámetro

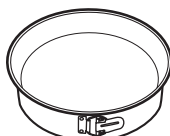

Bandeja para hornear

Oscuro, mate
26 cm de diámetro



Ramequines

Cerámica
8 cm de diámetro,
5 cm de altura

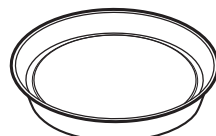



Molde para base

Oscuro, mate
28 cm de diámetro



Para obtener mejores resultados, apague el horno a la mitad del tiempo de secado, abra la puerta y déjelo enfriar durante una noche para completar el secado.

Para 1 bandeja, use el tercer nivel.

Para 2 bandejas, use el primer y cuarto nivel.





 VERDURAS	 (°C)	 (h)
Judías	60 - 70	6 - 8
Pimientos	60 - 70	5 - 6
Verduras para sopa	60 - 70	5 - 6
Setas	50 - 60	6 - 8
Hierbas aromáticas	40 - 50	2 - 3

Ajuste de temperatura 60 - 70 °C.

 FRUTA	 (h)
Ciruelas	8 - 10
Albaricoques	8 - 10
Manzanas en rodajas	6 - 8
Peras	6 - 9

9.17 Horneado húmedo + ventil.

Para obtener el mejor resultado, siga las recomendaciones de la tabla siguiente.

		 (°C)		 (min)
Rollitos dulces, 16 piezas	bandeja o bandeja honda	190	3	45 - 55
Pizza congelada, 0,35 kg	parrilla	190	2	45 - 50
Brazo de gitano	bandeja o bandeja honda	180	2	45 - 55
Brownie	bandeja o bandeja honda	180	2	55 - 60
Base de masa brisé	molde de base sobre parrilla	180	2	40 - 50
Pescado pochado, 0,3 kg	bandeja o bandeja honda	180	3	25 - 35
Pescado entero, 0,2 kg	bandeja o bandeja honda	180	3	25 - 35
Filete de pescado, 0,3 kg	molde para pizza sobre parrilla	180	3	40 - 50
Carne pochada, 0,25 kg	bandeja o bandeja honda	190	3	40 - 50
Shashlik, 0,5 kg	bandeja o bandeja honda	190	3	35 - 45
Galletas, 16 piezas	bandeja o bandeja honda	160	2	40 - 50
Mostachones de almendra, 24 piezas	bandeja o bandeja honda	150	2	35 - 45
Muffins, 12 piezas	bandeja o bandeja honda	160	2	35 - 45
Tarta salada, 20 piezas	bandeja o bandeja honda	170	2	35 - 45
Galletas crujientes de masa quebrada, 20 piezas	bandeja o bandeja honda	150	2	40 - 45
Tartaletas, 8 piezas	bandeja o bandeja honda	170	2	35 - 45
Verduras pochadas, 0,4 kg	bandeja o bandeja honda	180	3	45 - 55
Tortilla vegetariana	molde para pizza sobre parrilla	190	3	40 - 50

9.18 Información para los institutos de pruebas

Pruebas según: EN 60350, IEC 60350.



HORNEADO EN UN NIVEL. Horneado en moldes



(°C)



(min)



		(°C)	(min)	
Bizcocho sin grasa	Aire caliente	140 - 150	35 - 50	2
Bizcocho sin grasa	Cocción convencional	160	35 - 50	2
Tarta de manzana, 2 moldes, Ø 20 cm	Aire caliente	160	60 - 90	2
Tarta de manzana, 2 moldes, Ø 20 cm	Cocción convencional	180	70 - 90	1



HORNEADO EN UN NIVEL. Galletas



Use el tercer nivel.



(°C)



(min)

		(°C)	(min)	
Mantecados / Masa quebrada	Aire caliente	140	25 - 40	
Mantecados / Masa quebrada, precaliente el horno vacío	Cocción convencional	160	20 - 30	
Pastelillos, 20 unidades por bandeja, precaliente el horno vacío	Aire caliente	150	20 - 35	
Pastelillos, 20 unidades por bandeja, precaliente el horno vacío	Cocción convencional	170	20 - 30	



HORNEADO EN VARIOS NIVELES. Galletas



(°C)



(min)



		(°C)	(min)	
Mantecados / Masa quebrada	Aire caliente	140	25 - 45	1 / 4
Pastelillos, 20 unidades por bandeja, precaliente el horno vacío	Aire caliente	150	23 - 40	1 / 4
Bizcocho sin grasa	Aire caliente	160	35 - 50	1 / 4



GRILL



Precalente el horno vacío 5 minutos.



Grill con la temperatura ajustada al máximo.



(min)



Tostadas

Grill

1 - 3

5

Bistec de vaca, dar la vuelta a media cocción

Grill

24 - 30

4

10. MANTENIMIENTO Y LIMPIEZA



ADVERTENCIA!

Consulte los capítulos sobre seguridad.

10.1 Notas sobre la limpieza



Agentes limpiadores

Limpie la parte delantera del horno con un paño suave humedecido en agua templada y jabón suave.

Utilice un producto de limpieza para limpiar las superficies metálicas.

Limpie las manchas con un detergente suave.



Uso diario

Limpie el interior después de cada uso. La acumulación de grasa u otros residuos puede provocar un incendio.

No guarde la comida en el horno más de 20 minutos. Seque el interior con un paño suave después de cada uso.



Accesorios

Limpie todos los accesorios después de cada uso y déjelos secar. Use un paño suave humedecido en agua caliente y detergente suave. No lave los accesorios en el lavavajillas

No limpie los accesorios no adherentes utilizando un limpiador abrasivo ni objetos afilados.

10.2 Cómo quitar: Apoyos de baldas

Para limpiar el horno, retire los carriles de apoyo.

Paso 1 Apague el horno y espere a que esté frío.

Paso 2 Tire de la parte delantera del carril de apoyo para separarlo de la pared lateral.

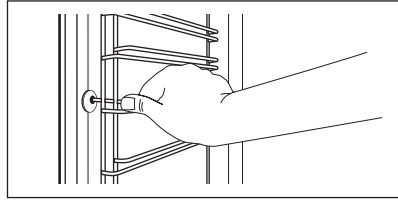

Paso 3 Tire del extremo trasero del carril de apoyo para despegarlo de la pared lateral y sáquelo.

Paso 4 Coloque los carriles de apoyo en el orden inverso.

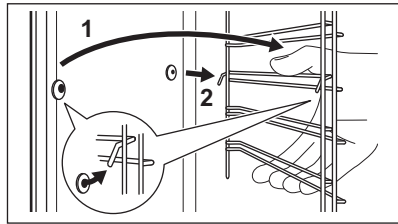

10.3 Cómo quitar: Grill



ADVERTENCIA!
Existe riesgo de quemaduras.

Paso 1 Apague el horno y espere a que esté frío para limpiarlo.
Retire los carriles telescópicos.

Paso 2 Sujete las esquinas de la parrilla. Tire hacia fuera hasta sentir la presión del muelle y extraiga de los dos soportes. El grill se separa del techo por la parte delantera.

Paso 3 Limpie el techo del horno con agua templada, un paño suave y detergente suave. Deje que se seque.

Paso 4 Instale el grill siguiendo el orden inverso.

Paso 5 Coloque los carriles de apoyo.

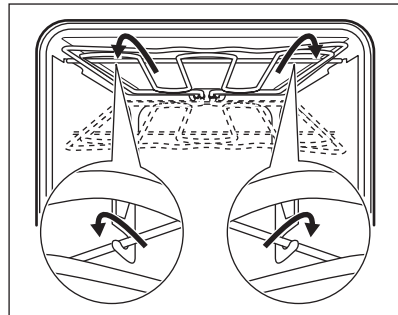

10.4 Cómo quitar e instalar: Puerta

Es posible retirar la puerta del horno y los paneles de cristal interiores para limpiarlos. El número de paneles de cristal es diferente según los modelos.



ADVERTENCIA!
La puerta es pesada.



PRECAUCIÓN!

Maneje con cuidado el cristal, especialmente alrededor de los bordes del panel frontal. El cristal puede romperse.

Paso 1 Abra la puerta por completo.

Paso 2 Levante y presione al máximo las palancas de bloqueo (A) de ambas bisagras de la puerta.

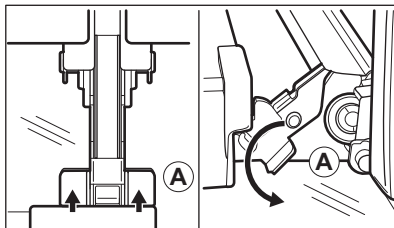

Paso 3 Cierre la puerta del horno hasta la primera posición de apertura (aproximadamente a un ángulo de 70°). Sostenga la puerta con una mano a cada lado y tire de ella hacia arriba y hacia afuera. Ponga la puerta con el lado exterior hacia abajo sobre un paño suave en una superficie nivelada.

Paso 4 Sujete el marco de la puerta (B) por el borde superior de la puerta por ambos lados y empuje hacia dentro para soltar el cierre.

Paso 5 Tire del borde del acabado de la puerta hacia delante para desengancharla.

Paso 6 Sujete uno tras otro los paneles de cristal de la puerta por su borde superior y extráigalos de la guía.

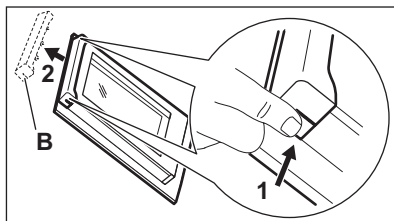

Paso 7 Limpie el panel de cristal con agua y jabón. Seque el panel de cristal con cuidado. No limpie los paneles de cristal en el lavavajillas.

Paso 8 Tras la limpieza, lleve a cabo los pasos anteriores en orden inverso.

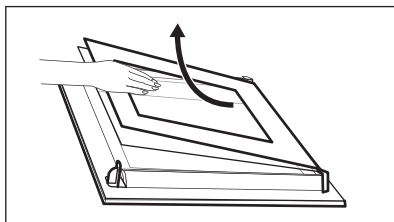

Paso 9 Introduzca primero el panel más pequeño y luego el de mayor tamaño y la puerta. Asegúrese de que los cristales se introducen en la posición correcta para evitar el sobrecalentamiento de la superficie de la puerta.

10.5 Cómo cambiar: Bombilla



ADVERTENCIA!

Riesgo de descarga eléctrica.
La lámpara puede estar caliente.

Antes de reemplazar la bombilla:

Paso 1	Paso 2	Paso 3
Apague el horno. Espere hasta que el horno esté frío.	Desconecte el horno de la red.	Coloque un paño en el fondo de la cavidad.

Bombilla superior

Paso 1 Gire la tapa de cristal para extraerla.

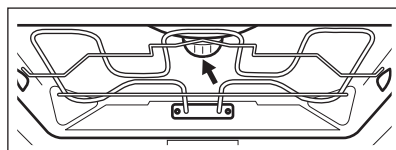

Paso 2 Limpie la tapa de cristal.

Paso 3 Cambie la bombilla por otra apropiada termorresistente hasta 300 °C.

Paso 4 Coloque la tapa de cristal.

11. SOLUCIÓN DE PROBLEMAS



ADVERTENCIA!

Consulte los capítulos sobre seguridad.

11.1 Qué hacer si...

En cualquier caso no incluido en esta tabla, por favor contacte con un Centro de Servicio Autorizado.

Problema	Compruebe que...
El horno no calienta.	Ha saltado el fusible.
La bombilla no funciona.	La bombilla se ha fundido.

11.2 Datos de servicio

Si no logra subsanar el problema, póngase en contacto con su distribuidor o el centro de servicio técnico.

Los datos que necesita para el centro de servicio técnico se encuentran en la placa de características. La placa de régimen se encuentra en el marco delantero de la cavidad del horno. No retire la placa de características de la cavidad del horno.

Es conveniente que anote los datos aquí:

Modelo (MOD.)

Número de producto (PNC)

Número de serie (S.N.)

12. EFICACIA ENERGÉTICA

12.1 Información del producto y Hoja de información del producto*

Nombre del proveedor	AEG
Identificación del modelo	EEB230010M 940321361
Índice de eficiencia energética	95.3
Clase de eficiencia energética	A
Consumo de energía con carga estándar, modo convencional	0.99 kWh/ciclo
Consumo de energía con carga estándar, modo con ventilador	0.81 kWh/ciclo
Número de cavidades	1
Fuente de calor	Electricidad
Volumen	71 l
Tipo de horno	Horno bajo encimera
Masa	31.5 kg

* Para la Unión Europea según los Reglamentos de la UE 65/2014 y 66/2014.

Para la República de Bielorrusia según STB 2478-2017, apéndice G; STB 2477-2017, anexos A y B.

Para Ucrania según 568/32020.

La clase de eficiencia energética no es aplicable a Rusia.

EN 60350-1 - Aparatos electrodomésticos - Parte 1: Placas, hornos, hornos de vapor y parrillas - Métodos para medir el rendimiento.

12.2 Ahorro energético



El horno tiene características que le ayudan a ahorrar energía durante la cocina de cada día.

Asegúrese de que la puerta del horno está cerrada cuando el horno funciona. No abra la puerta del horno muchas veces durante la cocción. Mantenga limpia la junta de la puerta y asegúrese de que está bien fijada en su posición.

Utilice utensilios de cocina de metal para mejorar el ahorro energético.

En la medida de lo posible, no precaliente el horno antes de cocinar.

Reduzca al máximo el tiempo entre horneados cuando prepare varios platos de una vez.

Cocción con ventilador

En la medida de lo posible, utilice las funciones de cocción con ventilador para ahorrar energía.

Calor residual

Para una duración de la cocción superior a 30 minutos, reduzca la temperatura del horno un mínimo de 3 - 10 minutos antes de que transcurra el tiempo de cocción. El calor residual dentro del horno seguirá cocinando.

Utilice el calor residual para calentar otros platos.

Mantener calientes los alimentos

Si desea utilizar el calor residual para mantener calientes los alimentos, seleccione el ajuste de temperatura más bajo posible.

Horneado húmedo + ventil.

Función diseñada para ahorrar energía durante la cocción.

13. ASPECTOS MEDIOAMBIENTALES

Recicle los materiales con el símbolo . Coloque el material de embalaje en los contenedores adecuados para su reciclaje. Ayude a proteger el medio ambiente y la salud pública, así como a reciclar residuos de aparatos eléctricos y electrónicos. No

deseche los aparatos marcados con el símbolo  junto con los residuos domésticos. Lleve el producto a su centro de reciclaje local o póngase en contacto con su oficina municipal.

FÖR PERFEKTA RESULTAT

Tack för att du valt denna AEG-produkt. Den har utvecklats för att du ska kunna använda den i många år, med innovativa funktioner som gör livet enklare – och som inte finns på alla enklare produkter. Ägna några minuter åt denna beskrivning för att få största möjliga utbyte av produkten.

Besök vår webbplats för att:



få tips om användning, broschyrer, felsökning, service- och reparationsinformation:
www.aeg.com/support



registrera din produkt för bättre service:
www.registreaeg.com



köpa tillbehör, förbrukningsvaror och originalreservdelar till din produkt:
www.aeg.com/shop

KUNDTJÄNST OCH SERVICE

Använd alltid originalreservdelar.

Ha följande uppgifter till hands när du kontaktar vår auktoriserade serviceverkstad:

Modell, artikelnummer, serienummer.

Informationen står på märkplåten.

 Varning/Försiktighet – Säkerhetsinformation

 Allmän information och tips

 Miljöinformation

Med reservation för ändringar.

INNEHÅLL

1. SÄKERHETSINFORMATION.....	200
2. SÄKERHETSINSTRUKTIONER.....	202
3. PRODUKTBESKRIVNING.....	205
4. KONTROLLPANELEN.....	205
5. FÖRE FÖRSTA ANVÄNDNING.....	206
6. DAGLIG ANVÄNDNING.....	206
7. ANVÄNDNING AV TILLBEHÖR.....	207
8. TILLVALSFUNKTIONER.....	208
9. TIPS.....	208
10. UNDERHÅLL OCH RENGÖRING.....	222
11. FELSÖKNING.....	225
12. ENERGIEFFEKTIVITET.....	225

1. SÄKERHETSINFORMATION

Läs noga de bifogade instruktionerna före installation och användning av produkten. Tillverkaren är inte ansvarig för

eventuella personskadorna eller andra skador som uppkommit som ett resultat av felaktig installation eller användning. Förvara alltid bruksanvisningen på en säker och tillgänglig plats för framtida bruk.

1.1 Säkerhet för barn och personer med funktionsnedsättning

- Denna produkt kan användas av barn från 8 års ålder och uppåt, och av personer med nedsatt fysisk, sensorisk eller mental förmåga, samt personer med bristande erfarenhet och kunskap om de övervakas eller instrueras om hur produkten används på ett säkert sätt och förstår de risker som är förknippade med användningen. Barn under 8 år eller personer med mycket omfattande och komplexa funktionsnedsättningar ska inte vistas i närheten av produkten utan ständig uppsikt.
- Barn ska hållas under uppsikt så att de inte leker med produkten.
- Håll allt förpackningsmaterial utom räckhåll för barn och kassera det på lämpligt sätt.
- **WARNING!** Barn och husdjur ska hållas borta från produkten när den är igång eller när den svalnar. Åtkomliga delar blir heta under användning.
- Om maskinen har ett barnlås ska den aktiveras.
- Barn får inte utföra rengöring och underhåll av produkten utan uppsikt.

1.2 Allmän säkerhet

- Installation av denna produkt och byte av kabeln får endast utföras av behörig person.
- Använd inte produkten innan den har installerats i inbyggnadsstrukturen.
- Bryt strömförsörjningen till apparaten före utförande av underhåll.
- Om nätsladden är skadad måste den bytas av tillverkaren, tillverkarens auktoriserade servicecenter eller personer med motsvarande utbildning, för att undvika elektrisk fara.

- För att undvika eventuell fara måste kontrollpanelen anslutas till specificerat värmeaggregat med matchande färger av kontakter.
- Sättet för fränkoppling måste införlivas i det fasta kablaget i enlighet med gällande anslutningsbestämmelser.
- **WARNING:** Kontrollera att produkten är avstängd innan du byter lampa för att undvika risken för elstötar.
- **WARNING:** Produkten och åtkomliga delar blir mycket varma under användning. Var försiktig så att du undviker att vidröra värmeelementen.
- Använd alltid ugnsvantar för att ta ut eller sätta in tillbehör eller eldfasta formar.
- För att ta bort ugnsstegarna drar du först ut den främre delen av ugnsstegen och sedan den bakre delen från sidoväggarna. Sätt tillbaka ugnsstegarna i omvänd ordning.
- Använd inte ångrengörare vid rengöring av produkten.
- Använd inte skarpa rengöringsmedel med slipeffekt eller vassa metallskrapor för att rengöra ugnsluckans glasskivor eftersom dessa kan repa ytan, vilket i sin tur kan leda till att glaset spricker.

2. SÄKERHETSINSTRUKTIONER

2.1 Installation



WARNING!

Endast en behörig person får installera den här produkten.

- Avlägsna allt förpackningsmaterial.
- Installera eller använd inte en skadad produkt.
- Följ installationsinstruktionerna som följer med produkten.
- Var alltid försiktig när produkten rör sig eftersom den är tung. Använd alltid skyddshandskar och täkta skor.
- Dra aldrig produkten i handtaget.
- Installera produkten på en säker och lämplig plats som uppfyller installationskraven.
- Köksskåpet och inbyggnaden måste ha passande mått.

- Minsta avstånd till andra produkter ska beaktas.
- Kontrollera, före installation av produkten, att ugnsluckan kan öppnas enkelt utan motstånd.
- Delar av produkten är strömförande. Stäng produkten med skåpluckan för att undvika att vidröra farliga delar.
- Produkten är utrustad med ett elektriskt kylsystem. Den måste användas med den elektriska strömförsörjningen.
- En inbyggnad enhet måste uppfylla stabilitetskraven enligt DIN 68930.

Skåpets minimihöjd (minsta höjd för skåpet under bänk)	578 (600) mm
--	--------------

Skåpets bredd	560 mm
---------------	--------

Skåpets djup	550 (550) mm
--------------	--------------

Höjd på produktens främre del	594 mm
Höjd på produktens bakre del	576 mm
Bredd på produktens främre del	595 mm
Bredd på produktens bakre del	559 mm
Produktens djup	567 mm
Inbyggnadsdjup för produkten	546 mm
Djup med öppen lucka	1027 mm
Minsta storlek på ventilationsöppningen. Öppning placerad nedtill på vänstra sidan	560 x 20 mm
Monteringskruvar	4 x 25 mm

2.2 Elanslutning



VARNING!

Risk för brand och elektriska stötar.

- Alla elektriska anslutningar ska göras av en behörig elektriker.
- Produkten måste jordas.
- Se till att de parametrarna på märkskylten överensstämmer med elnätets elektricitet.
- Använd alltid ett korrekt installerat, stötsäkert och jordat eluttag.
- Använd inte grenuttag eller förlängningssladdar.
- Kontrollera så att du inte skadar stickkontakten och nätkabeln. Om produktens nätkabel behöver bytas måste det göras av vårt auktoriserade servicecenter.
- Låt inte nätkablar komma i kontakt med eller komma nära produktens lucka eller nichen nedanför produkten, speciellt inte när den är igång eller om luckan är het.
- Stötskyddet för strömförande och isolerade delar måste fästas på ett sådant sätt att det inte kan tas bort utan verktyg.
- Anslut stickkontakten till eluttaget först vid slutet av installationen. Kontrollera att stickkontakten är åtkomlig efter installationen.

- Anslut inte stickkontakten om vägguttaget sitter löst.
- Dra inte i anslutningssladden för att koppla bort produkten från eluttaget. Ta alltid tag i stickkontakten.
- Använd endast rätt isoleringsenheter: strömbrytare, säkringar (säkringar av skruttyp tas ur hållaren), jordfelsbrytare och kontaktorer.
- Den elektriska installationen måste ha en isolationsenhet så att du kan koppla från produkten från nätet vid alla poler. Kontaktöppningen på isolationsenheten måste vara minst 3 mm bred.
- Denna produkt levereras med en huvudkontakt och en huvudkabel.

2.3 Använd



VARNING!

Risk för skador, brännskador, elstötar eller explosion föreligger.

- Denna produkt är endast avsedd för hushållsbruk.
- Ändra inte produktens specifikationer.
- Kontrollera att ventilationsöppningarna inte är blockerade.
- Låt inte produkten stå utan uppsikt under användning.
- Stäng av produkten efter varje användningstillfälle.
- Var försiktig när du öppnar produktens lucka medan produkten är påslagen. Varm luft kan strömma ut.
- Använd inte produkten med våta händer eller när den har kontakt med vatten.
- Tryck inte på den öppna luckan.
- Använd inte produkten som arbets- eller avlastningsyta.
- Öppna luckan försiktigt. Användning av ingredienser med alkohol kan orsaka blandning av alkohol och luft.
- Låt inte gnistor eller öppna lågor komma i kontakt med produkten när du öppnar luckan.
- Placera inte brandfarliga produkter eller föremål som är våta med brandfarliga produkter i, i närheten av eller på produkten.



VARNING!

Risk för skador på produkten föreligger.

- För att förhindra skador eller missfärgning på emaljen:
 - placera inte eldfasta formar eller andra föremål direkt på ugsnbotten.
 - lägg inte aluminiumfolie direkt på ugsnbotten.
 - håll inte vatten direkt i den heta produkten.
 - Låt inte fuktiga maträtter eller matvaror stå kvar i produkten när tillagningen är klar.
 - var försiktig när du tar bort eller installerar tillbehören.
- Missfärgning av emaljen eller den rostfria ytan påverkar inte produktens funktion.
- Använd en djup form för mjuka kakor. Fruktjuice kan orsaka fläckar som inte går att ta bort.
- Denna produkt är endast avsedd för matlagning. Den får inte användas för andra ändamål, t.ex. rumsuppvärmning.
- Tillaga alltid med ugsnsluckan stängd.

2.4 Underhåll och rengöring



VARNING!

Det finns risk för personskador, brand eller skador på produkten.

- Stäng av produkten och koppla bort den från eluttaget före underhåll.
- Se till att produkten har svalnat. Det finns även risk för att glaspanelerna kan spricka.
- Byt omedelbart ut luckans glaspaneler om de är skadade. Kontakta auktoriserat servicecenter.
- Var försiktig när du tar bort luckan. Luckan är tung!
- Rengör produkten regelbundet för att förhindra att ytmaterialet försämras.
- Rengör produkten med en fuktig, mjuk trasa. Använd bara milda

rengöringsmedel. Använd inte produkter med slipeffekt, skursvampar, lösningsmedel eller metallföremål.

- Om du använder en ugnssprej ska du följa säkerhetsanvisningarna på förpackningen.

2.5 Lampa inuti produkten



VARNING!

Risk för elektrisk stöt!

- När det gäller lampan/lamporna i denna produkt och reservlampor som säljs separat: Dessa lampor är avsedda att tåla extrema fysiska förhållanden i hushållsapparater, såsom temperatur, vibration, fuktighet eller är avsedda att signalera information om produktens driftsstatus. De är inte avsedda att användas i andra produkter eller som rumsbelysning i hemmet.
- Använd bara lampor med samma specifikationer.

2.6 Service

- Kontakta en auktoriserad serviceverkstad för reparation av produkten.
- Använd endast originaldelar.

2.7 Avyttring



VARNING!

Risk för kvävning eller skador.

- Kontakta kommunen för information om hur produkten ska kasseras.
- Koppla loss produkten från eluttaget.
- Klipp av elkabeln nära produkten och kassera den.
- Ta bort luckspärren för att förhindra att barn eller husdjur blir instängda i maskinen.

3. PRODUKTBESKRIVNING

3.1 Allmän översikt

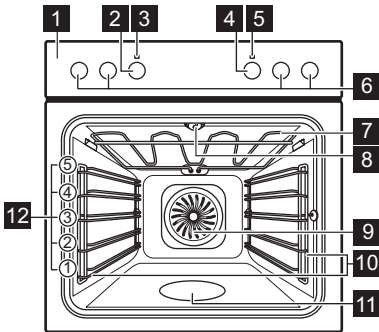

- 1 Kontrollpanel
- 2 Funktionsratt för tillagningsfunktioner
- 3 Strömlampa/symbol
- 4 Temperaturinställningsratt
- 5 Temperaturindikator/symbol
- 6 Vred för kokzonerna
- 7 Värmeelement
- 8 Lampa
- 9 Fläkt
- 10 Ugnsstegar, borttagbara
- 11 Ugnsutrymmets upphöjning
- 12 Hyllplaceringar

3.2 Tillbehör

Galler

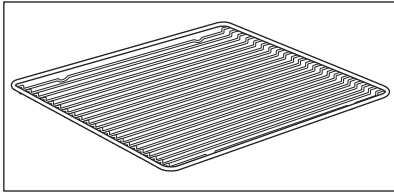

För kokkärl, kakformar, stekar.

Ugnspanna

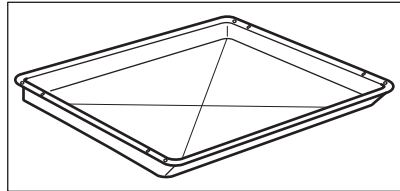

För kakor och småkakor. För bakning och stekning eller som fettuppsamlingsfat.

4. KONTROLLPANELEN

4.1 Kokzonernas kontrollvred

Du kan styra hällen med hjälp av kokzonernas kontrollvred.



Du måste läsa avsnittet om säkerhet i hällens bruksanvisning.

4.2 Värmeinställningar

Vredindikering	Funktion
0	Avstängt läge
	Varmhållningsläge

Vredindikering	Funktion
1 - 9	Värmeinställningar

1. Vrid vredet till önskat värmeläge.
2. När tillagningen är klar, vrid vredet till av-position.

4.3 Automax



Gäller endast för hällar med automatisk uppvärmning.

AutoMax-funktionen värmer upp kokzonen med full effekt under en begränsad tid.

1. Vrid vredet för kokzonen medurs så långt som möjligt (förbi det högsta värmeläget).
2. Ställ genast in önskat värmeläge.
3. Stäng av funktionen genom att vrida vredet till "av"-läget.

4.4 Använda dubbelzonen (om tillämpligt)



För att aktivera dubbelzonen, vrid vredet medurs. Vrid inte till stopposition.

1. Vrid vredet medurs till position 9.
2. Vrid vredet sakta tills ett klick hörs. De två tillagningszonerna är på.
3. För att ställa in till önskad värmeinställning, se "Värmeinställningar".

5. FÖRE FÖRSTA ANVÄNDNING



WARNING!

Se säkerhetsavsnitten.

5.1 Före första användning

Ugnen kan avge lukt och rök under uppvärmning. Se till att rummet är ventilerat.



Steg 1

Rengöra ugnen

1. Ta ut alla tillbehör och flyttbara ugnsstegar ur ugnen.
2. Torka av ugnen och tillbehören med en mjuk trasa med varmt vatten och mildt diskmedel.



Steg 2

Förvärm den tomma ugnen

1. Ställ in maxtemperatur för funktionen: . Tid: 1 tim.
2. Ställ in maxtemperatur för funktionen: . Tid: 15 min.

Stäng av ugnen och vänta tills den har svalnat. Sätt in tillbehören och de löstagbara ugnsstegarna i ugnen.

6. DAGLIG ANVÄNDNING



WARNING!

Se säkerhetsavsnitten.

6.1 Hur man ställer in: Värmefunktion

Steg 1 Vrid på vredet för värmefunktioner för att välja en värmefunktion.

Steg 2 Vrid på kontrollvredet för att välja temperatur.

Steg 3

När matlagningen är klar, vrid på vreden till avstängt läge för att stänga av ugnen.







6.2 Värmefunktioner



Värmefunktion Program

0

Ugnen är avstängd.

Avstängt läge

Värmefunktion	Program
	För att tända ugnsbelysningen.
Belysning	
	För bakning eller torkning på upp till tre ugnsnivåer samtidigt. Välj en temperatur 20 till 40 °C lägre än för Översta - / bottenvärme.
Varmluft	
	För att tillaga pizza. För att bryna ordentligt och få en knaprig botten.
Pizza-funktionen	
	Bakning och stekning på en ugnsnivå.
Översta - / bottenvärme	
	För bakning av kakor med knaprig botten och för konservering av livsmedel.
Bottenvärme	
	För att tina mat (grönsaker och frukt). Upptiningstiden beror på mängden och storleken på den frysta maten.
Upptining	
	Denna funktion är för att spara energi under tillagningen. När du använder den här funktionen kan temperaturen i ugnen skilja sig från inställd temperatur. Värmeeffekten kan minska. Mer information finns i kapitlet "Daglig användning" och anvisningar om: Varmluft med fukt.
Varmluft med fukt	

Värmefunktion	Program
	För grillning av tunnskurna stycken och brödrostning.
Grill	
	Varmluftstekning på första ugnsnivån av större köttstycken eller fågelkött med ben. För att bryna och göra gratänger.
Varmluftsgrillning	
	Lampan kan släckas automatiskt vid en temperatur under 60 °C med vissa ugnsfunktioner.

6.3 Anvisningar om: Varmluft med fukt

Denna funktion användes för att uppfylla kraven för energieffektivitet och ekodesign enligt EU 65/2014 och EU 66/2014. Provning enligt EN 60350-1.

Ugnsluckan ska vara stängd under tillagningen så att funktionen inte avbryts och ugnen fungerar med högsta möjliga energieffektivitet.

För tillagningsinstruktioner, se kapitlet "Råd och tips", Varmluft med fukt. För instruktioner om allmän energibesparing, se kapitlet "Energieffektivitet", Energibesparing.

7. ANVÄNDNING AV TILLBEHÖR



WARNING!

Se säkerhetsavsnitten.

7.1 Sätta in tillbehör

Liten inbuktning upptill ökar säkerheten. Fördjupningarna ger också ett tipskydd.

Den höga kanten runt hyllan förhindrar kokkärlen från att glida ner.

Galler:

För in gallret mellan skenorna på ugnsstegen .

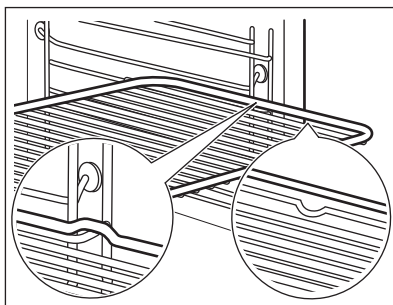
**Djup plåt:**

Skjut in plåten mellan stegparen på önskad nivå.

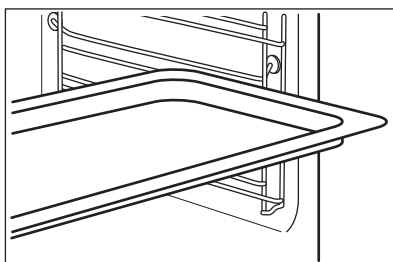
**Galler, Djup plåt:**

Tryck in plåten mellan skenorna på hyllstöden och ugnsgallret på skenorna ovan.

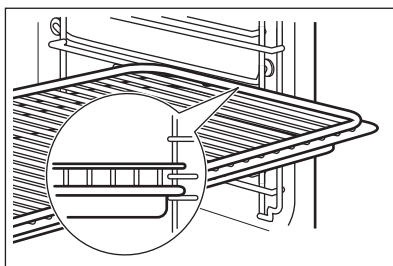

8. TILLVALSFUNKTIONER

8.1 Kylfläkt

När ugnen är på, slås kylfläkten på automatiskt för att hålla ugnens ytor svala.

Om du stänger av ugnen kan kylfläkten fortsätta att vara igång tills ugnen är sval.

9. TIPS



Se säkerhetsavsnitten.

9.1 Exempel på tillagningstillämpningar för inbyggnadshällen

Värmeinställning	Program	Tid (min)	Tips
1	För varmhållning av maträtter.	efter behov	Lägg ett lock på ett kokkärl.
1 - 2	För att laga hollandaisesås och smälta smör, choklad och gelatin.	5 - 25	Blanda med jämna mellanrum.
1 - 2	För att få fluffiga omeletter och äggstanning att stelna.	10 - 40	Tillaga med lock.
2 - 3	För att sjuda ris och mjölkbaserade rätter och för att värma upp färdiglagad mat.	25 - 50	Tillsätt minst två gånger så mycket vätska som ris. Rör om mjölkkrätter efter halva tiden.
3 - 4	För att ångkoka grönsaker, fisk och kött.	20 - 45	Tillsätt några matskedar vätska.
4 - 5	För att ångkoka potatis.	20 - 60	Använd max. ¼ liter vatten till 750 g potatis.
4 - 5	För att tillaga större mängder mat, stuvningar och soppor.	60 - 150	Tillsätt max 3 l vätska till ingredienserna.
6 - 7	För att lätt steka schnitzel, kalv cordon bleu, kotletter, kroetter, korv, lever, ägg, pannkakor och munkar och för att tillaga en redning.	efter behov	Vänd efter halva tiden.
7 - 8	För att kraftigt steka potatiskroetter, biff och stekar.	5 - 15	Vänd efter halva tiden.
9	För att koka stora mängder vatten, koka pasta, bryna kött (gulasch, grytstek) och fritera pommes frites.		

9.2 Tillagningsrekommendationer



Temperaturen och gräddningstiderna i tabellerna är endast riktvärden. De beror på recepten samt på ingrediensernas kvalitet och mängd.

Din ugn kan ha andra bak-/stekegenskaper än din gamla ugn. Tabellerna nedan visar rekommenderade inställningar för temperatur, tillagningstid och hyllposition för specifika typer av mat.

Om du inte kan hitta inställningarna för ett visst recept kanske du kan använda inställningarna för ett liknande recept.

9.3 Gräddning

För första gräddningen, använd den lägre temperaturen.

Du kan förlänga gräddningstiden med 10–15 minuter om du bakar på mer än en nivå.

Bakverk vid olika nivåer blir inte alltid lika bruna. Du behöver inte ändra





ugnstemperaturen om de blir olika bruna. Detta jämnar ut sig under bakningen.

Plåtarna i ugnen kan vrida sig under bakning. När plåtarna kallnar igen återtar de sin normala form.

9.4 Tips för bakning

Bakresultat	Möjlig orsak	Lösning
Kakans botten är inte tillräckligt gräddad.	Ugnsnivån är fel.	Ställ kakan på en lägre ugnsnivå.
Kakan faller ihop och blir degig eller får vattenränder.	Ugnstemperaturen är för hög.	Ställ in något lägre ugnstemperatur nästa gång.
	Ugnstemperaturen är för hög och gräddningstiden är för kort.	Ställ in längre gräddningstid och lägre ugnstemperatur nästa gång.
Kakan är för torr.	Ugnstemperaturen är för låg.	Ställ in högre ugnstemperatur nästa gång.
	För lång gräddningstid.	Ställ in kortare gräddningstid nästa gång.
Kakan blir ojämn.	Ugnstemperaturen är för hög och gräddningstiden är för kort.	Ställ in längre gräddningstid och lägre ugnstemperatur nästa gång.
	Kaksmeten har inte fördelats jämnt.	Fördela smeten jämnare på bakplåten nästa gång.
Kakan blir inte klar på tiden som anges i receptet.	Ugnstemperaturen är för låg.	Ställ in något högre ugnstemperatur nästa gång.



9.5 Baka på en hyllnivå

 BAKA I FORMAR			 (°C)	 (min.)	
Tärtbotten av mördeg, förvärm den tomma ugnen	Varmluft	170 - 180	10 - 25	2	
Tärtbotten av sockerkakssmet	Varmluft	150 - 170	20 - 25	2	
Sockerkaka / Brioche	Varmluft	150 - 160	50 - 70	1	
Sandkaka / Fruktkakor	Varmluft	140 - 160	70 - 90	1	
Cheesecake	Översta - / bottenvärme	170 - 190	60 - 90	1	

Använd den tredje hyllpositionen.

Använd funktionen: Varmluft.

Använd en bakplåt.

 KAKOR/BAKVERK/BRÖD	 (°C)	 (min.)
Kaka med smördegstopping	150 - 160	20 - 40

**KAKOR/BAKVERK/BRÖD****(°C)****(min.)**

Fruktpaj (på jästdeg/sockerkakssmet), använd en långpanna

150

35 - 55

Fruktpaj av mördeg

160 - 170

40 - 80

Förvärm den tomma ugnen.

Använd funktionen: Översta - / bottenvärme.

Använd en bakplåt.

**KAKOR/
BAKVERK/BRÖD****(°C)****(min.)**

Rulltårta

180 - 200

10 - 20

3

Rågbröd:

först: 230

20

1

sedan: 160 - 180

30 - 60

Mandelsockerkaka / Sockerkakor

190 - 210

20 - 30

3

Petits-choux med fyllning / Eclairs

190 - 210

20 - 35

3

Veteflåta / Runt bröd

170 - 190

30 - 40

3

Fruktpaj (på jästdeg/sockerkakssmet), använd en långpanna

170

35 - 55

3

Jästkaka med känslig fyllning (t.ex. kvarg, grädde, kräm)

160 - 180

40 - 80

3

Christstollen

160 - 180

50 - 70

2

Använd den tredje hyllpositionen.

**SLÄTA BULLAR****(°C)****(min.)**

Mördegskakor, kex

Varmluft

150 - 160

10 - 20

Franskbullar, förvärm den tomma ugnen

Varmluft

160

10 - 25

Kakor av sockerkakssmet

Varmluft

150 - 160

15 - 20

Smördegskakor, förvärm den tomma ugnen

Varmluft

170 - 180





20 - 30

Småkakor av jästdeg

Varmluft





150 - 160

20 - 40

 SLÄTA BULLAR		 (°C)	 (min.)
Mandelbiskvier	Varmluft	100 - 120	30 - 50
Bakverk med äggvita, maräng- er / Maräng	Varmluft	80 - 100	120 - 150
Franskbullar, förvärm den tom- ma ugnen	Översta - / bottenvärme	190 - 210	10 - 25

9.6 Puddingar och gratänger





Använd den första hyllpositionen.





		 (°C)	 (min.)
Ostbaguetter	Varmluft	160 - 170	15 - 30
Grönsaksgratäng, förvärm den tomma ugnen	Varmluftsgrillning	160 - 170	15 - 30
Lasagne	Översta - / bottenvärme	180 - 200	25 - 40
Fiskpudding	Översta - / bottenvärme	180 - 200	30 - 60
Fyllda grönsaker	Varmluft	160 - 170	30 - 60
Söta puddingar	Översta - / bottenvärme	180 - 200	40 - 60
Makaronipudding	Översta - / bottenvärme	180 - 200	45 - 60

9.7 Baka på flera nivåer

Använd funktionen: Varmluft.

Använd bakplåtarna.

 KAKOR/ BAKVERK	 (°C)	 (min.)	 2 positioner
Petits-choux med fyllning / Eclairs, förvärm den tom- ma ugnen	160 - 180	25 - 45	1 / 4
Smuldegspaj	150 - 160	30 - 45	1 / 4

 KA-KOR/SMÅKAKOR/BAKVERK/BULLAR	 (°C)	 (min.)	 2 positioner	3 positioner
Franskbullar	180	20 - 30	1 / 4	-
Mördegskakor, kex	150 - 160	20 - 40	1 / 4	1 / 3 / 5
Kakor av sockerkakssmet	160 - 170	25 - 40	1 / 4	-
Smördegskakor, förvärm den tomma ugnen	170 - 180	30 - 50	1 / 4	-
Småkakor av jästdeg	160 - 170	30 - 60	1 / 4	-
Mandelbiskvier	100 - 120	40 - 80	1 / 4	-
Maränger / Maränger	80 - 100	130 - 170	1 / 4	-

9.8 Tips gällande ugnstekning

Använd värmebeständiga ugnsgarnar.

Stek magert kött övertäckt (t.ex. aluminiumfolie).

Tillaga stora stekar eller kyckling direkt på plåten eller på gallret med en plåt under.

Håll lite vatten på plåten för att förhindra att droppande fett bränner fast.







Vänd steken efter 1/2 - 2/3 av stektiden.

Stek kött och fisk i stora bitar som väger minst 1 kg.

Ös köttet med sin egen köttsaft flera gånger under stekning.

9.9 Stekning

Använd den första hyllpositionen.

 NÖTKÖTT				 (°C)	 (min.)
Grytstek	1 - 1,5 kg	Översta - / bottenvärme		230	120 - 150
Engelsk rostbiff eller filé, röd, förvärm den tomma ugnen	per cm tjocklek	Varmluftsgrillning		190 - 200	5 - 6
Engelsk rostbiff eller filé, medium, förvärm den tomma ugnen	per cm tjocklek	Varmluftsgrillning		180 - 190	6 - 8
Engelsk rostbiff eller filé, välstekt, förvärm den tomma ugnen	per cm tjocklek	Varmluftsgrillning		170 - 180	8 - 10



FLÄSK



Använd funktionen: Varmluftsgillning.



(kg)



(°C)



(min.)

Bog / Hals / Skinkstek 1 - 1.5 160 - 180 90 - 120

Kotletter / Revbensspjäll 1 - 1.5 170 - 180 60 - 90

Köttfärslimpa 0.75 - 1 160 - 170 50 - 60

Fläsklägg, lagad i förväg 0.75 - 1 150 - 170 90 - 120



KALV



Använd funktionen: Varmluftsgillning.



(kg)



(°C)



(min.)

Kalvstek 1 160 - 180 90 - 120

Kalvlägg 1.5 - 2 160 - 180 120 - 150



LAMM



Använd funktionen: Varmluftsgillning.



(kg)



(°C)



(min.)

Lamm, lägg / Lammstek 1 - 1.5 150 - 170 100 - 120

Lamm, sadel 1 - 1.5 160 - 180 40 - 60



VILT



Använd funktionen: Översta - / bottenvärme.



(kg)



(°C)



(min.)

Sadel / Hare, lägg, för-
värm den tomma ugnen

upp till 1

230

30 - 40

Rådjur, sadel

1.5 - 2

210 - 220

35 - 40

Bog

1.5 - 2

180 - 200

60 - 90



FÅGEL



Använd funktionen: Varmluftsgrellning.



(kg)



(°C)



(min.)

Bitar av fågel

0,2 - 0,25 var

200 - 220

30 - 50

Halv kyckling

0,4 - 0,5 var

190 - 210

35 - 50

Kyckling, unghöna

1 - 1.5

190 - 210

50 - 70

Anka

1.5 - 2

180 - 200

80 - 100

Gås

3.5 - 5

160 - 180

120 - 180

Kalkon

2.5 - 3.5

160 - 180

120 - 150

Kalkon

4 - 6

140 - 160

150 - 240



FISK (ÅNGKOKT)



Använd funktionen: Översta - / bottenvärme.



(kg)



(°C)



(min.)





Hel fisk







1 - 1.5







210 - 220

40 - 60

9.10 Knaprig tillagning med inställningen: Pizza-funktionen

 PIZZA		
 Använd den första hyllpositionen.		
	 (°C)	 (min.)
Pajer	180 - 200	40 - 55
Ugnsbakad spenat	160 - 180	45 - 60
Quiche lorraine / Schweizisk ost-paj	170 - 190	45 - 55
Cheesecake	140 - 160	60 - 90
Grönsakspaj	160 - 180	50 - 60

 PIZZA		
 Förvärm den tomma ugnen före tillagning.		
 Använd den andra hyllpositionen.		
	 (°C)	 (min.)
Pizza, tunn boten, använd en långpanna	200 - 230	15 - 20

 PIZZA		
 Förvärm den tomma ugnen före tillagning.		
 Använd den andra hyllpositionen.		
	 (°C)	 (min.)
Pizza, tjock boten	180 - 200	20 - 30
Osyrat bröd	230 - 250	10 - 20
Smördegskakor	160 - 180	45 - 55
Flammkuchen	230 - 250	12 - 20
Pirog	180 - 200	15 - 25

9.11 Grill

Förvärm den tomma ugnen före tillagning.

Grilla endast tunna bitar av kött eller fisk.

Placera en form på första hyllpositionen för att samla upp fett.



GRILL



Använd funktionen: Grill



(°C)



(min.)

1:a sidan



(min.)

2:a sidan



	(°C)	(min.) 1:a sidan	(min.) 2:a sidan	
Engelsk rostbiff	210 - 230	30 - 40	30 - 40	2
Oxfile	230	20 - 30	20 - 30	3
Fläskkotlett	210 - 230	30 - 40	30 - 40	2
Kalv, fransyska	210 - 230	30 - 40	30 - 40	2
Lamm, sadel	210 - 230	25 - 35	20 - 25	3
Hel fisk, 0,5 kg - 1 kg	210 - 230	15 - 30	15 - 30	3 / 4

9.12 Fryst mat



AVFROSTNING



Använd funktionen: Varmluft.



(°C)



(min.)



	(°C)	(min.)	
Fryst pizza	200 - 220	15 - 25	2
Fryst panpizza	190 - 210	20 - 25	2
Kyld pizza	210 - 230	13 - 25	2
Fryst portionspizza	180 - 200	15 - 30	2
Pommes Frites, tunna	200 - 220	20 - 30	3
Pommes Frites, tjocka	200 - 220	25 - 35	3
Croquetter / Kroketter	220 - 230	20 - 35	3
Hash browns	210 - 230	20 - 30	3
Lasagne / Cannelloni, färsk	170 - 190	35 - 45	2
Lasagne / Cannelloni, fryst	160 - 180	40 - 60	2
Makaronipudding med ost	170 - 190	20 - 30	3
Kycklingvingar	190 - 210	20 - 30	2





9.13 Upptining

Ta bort förpackningen från maten och lägg den sedan på en tallrik.

Täck inte över maten eftersom det kan förlänga avfrostningstiden.

Använd den första hyllpositionen.

Om du lagar större portioner ska en tom tallrik placeras upp och ner på botten av ugnen. Lägg maten i en djup form och ställ den ovanpå tillriken inne i ugnen. Ta bort hyllstöden om det behövs.

	 (kg)	 (min.) Upptiningstid	 (min.) Mer avfrostnings- tid	
Kyckling	1	100 - 140	20 - 30	Vänd efter halva tiden.
Kött	1	100 - 140	20 - 30	Vänd efter halva tiden.
Öring	0.15	25 - 35	10 - 15	-
Jordgubbar	0.3	30 - 40	10 - 20	-
Smör	0.25	30 - 40	10 - 15	-
Grädde	2 x 0,2	80 - 100	10 - 15	Vispa grädden medan den fortfarande är något fryst.
Tårta	1.4	60	60	-

9.14 Konservering

Använd funktionen Bottenvärme.

Använd enbart konserveringsburkar av samma mått som finns att köpa.

Använd inte glas med skruvlock och bajonettförslutning eller metallburkar.

Använd den första hyllpositionen.

Sätt inte mer än sex enliters burkar på plåten.

Fyll upp burkarna med lika mycket i varje och förslut med ett klämlöck.

Burkarna får inte röra vid varandra.

Häll ca. 1/2 liter vatten i bakplåten så att det blir tillräckligt fuktigt i ugnen.

När vätskan i burkarna börjar sjuda (efter ca 35 - 60 minuter med enlitersburkarna) stänger du av ugnen eller sänker temperaturen till 100 °C (se tabellen).



Ställ in temperaturen till 160 - 170 °C.

 MJUK FRUKT	 (min.) Tillagningstid tills det börjar sjuda
--	---

Jordgubbar / Blåbär / Hal- 35 - 45
lon / Mogna krusbär

 STEN- FRUKT	 (min.) Tillagnings- tid tills det börjar sjuda	 (min.) Fortsätt tillaga på 100 °C
--	--	---

Persikor / Kvit- 35 - 45 10 - 15
ten / Plommon

 GRÖNSAKER	 (min.) Tillagnings- tid tills det börjar sjuda	 (min.) Fortsätt tilla- ga på 100 °C
Morötter	50 - 60	5 - 10
Gurka	50 - 60	-
Blandade inlagda grönsaker	50 - 60	5 - 10
Kålrabbi / Ärter / Sparris	50 - 60	15 - 20

9.15 Torkning - Varmluft

Täck plåten med smörpapper eller bakplåtspapper.

För bästa resultat, stäng av ugnen efter halva torktiden, öppna luckan och låt den svalna och torka över natten.

För en plåt, använd den tredje hyllpositionen.

För två plåtar, använd den första och den fjärde hyllpositionen.

9.16 Varmluft med fukt - rekommenderade tillbehör

Använd mörka och icke reflekterande burkar och formar. De absorberar värme bättre än ljusa färger och reflektiva formar.

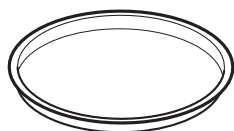

Pizzaform

Mörk, icke reflekterande
28 cm i diameter

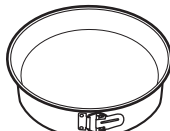

Ugnsform

Mörk, icke reflekterande
26 cm i diameter



Portionsformar

Keramik
8 cm diameter, 5
cm hög





Tärtbottenform



Mörk, icke reflekterande
28 cm i diameter





9.17 Varmluft med fukt

För bästa resultat ska du följa förslagen som listas i tabellen nedan.

 GRÖNSA- KER	 (°C)	 (tim)
Bönor	60–70	6–8
Paprika	60–70	5–6
Soppgrönsaker	60–70	5–6
Svamp	50–60	6–8
Örter	40–50	2–3







Ställ in temperaturen på 60–70 °C.

 FRUKT	 (tim)
Plommon	8–10
Aprikoser	8–10
Äppelskivor	6–8
Päron	6–9

		 (°C)		 (min.)
Söta bullar, 16 st	långpanna eller djup form	190	3	45 - 55
Fryst pizza, 0,35 kg	galler	190	2	45 - 50
Rulltårta	långpanna eller djup form	180	2	45 - 55
Brownie	långpanna eller djup form	180	2	55 - 60
Sockerkaksbotten	flan-form på galler	180	2	40 - 50
Pocherad fisk, 0,3 kg	långpanna eller djup form	180	3	25 - 35
Hel fisk, 0,2 kg	långpanna eller djup form	180	3	25 - 35
Fiskfilé, 0,3 kg	pizzaform på galler	180	3	40 - 50
Kokt kött, 0,25 kg	långpanna eller djup form	190	3	40 - 50
Shashlik, 0,5 kg	långpanna eller djup form	190	3	35 - 45
Cookies, 16 st	långpanna eller djup form	160	2	40 - 50
Mandelbiskvier, 24 st	långpanna eller djup form	150	2	35 - 45
Muffins, 12 st	långpanna eller djup form	160	2	35 - 45
Matpaj, 20 st	långpanna eller djup form	170	2	35 - 45
Mördegkakor, 20 st	långpanna eller djup form	150	2	40 - 45
Tarteletter, 8 st	långpanna eller djup form	170	2	35 - 45
Grönsaker, kokta, 0,4 kg	långpanna eller djup form	180	3	45 - 55
Vegetarisk omelett	pizzaform på galler	190	3	40 - 50

9.18 Information till provanstalter

Tester enligt: EN 60350, IEC 60350.

 BAKNING PÅ EN NIVÅ. Bakverk i formar				
		 (°C)	 (min.)	
Lätt sockerkaka utan fett	Varmluft	140 - 150	35 - 50	2
Lätt sockerkaka utan fett	Översta - / bottenvärme	160	35 - 50	2
Äppelpaj, 2 formar Ø20 cm	Varmluft	160	60 - 90	2
Äppelpaj, 2 formar Ø20 cm	Översta - / bottenvärme	180	70 - 90	1



BAKNING PÅ EN NIVÅ. Småkakor



Använd den tredje hyllpositionen.



(°C)



(min.)

Mördegskakor / Smördegskakor	Varmluft	140	25 - 40
Mördegskakor / Smördegskakor, förvärm den tomma ugnen	Översta - / bottenvärme	160	20 - 30
Småkakor, 20 stycken/plåt, förvärm den tomma ugnen	Varmluft	150	20 - 35
Småkakor, 20 stycken/plåt, förvärm den tomma ugnen	Översta - / bottenvärme	170	20 - 30



BAKNING PÅ FLERA NIVÅER. Småkakor



(°C)



(min.)



Mördegskakor / Smördegskakor	Varmluft	140	25 - 45	1 / 4
Småkakor, 20 stycken/plåt, förvärm den tomma ugnen	Varmluft	150	23 - 40	1 / 4
Lätt sockerkaka utan fett	Varmluft	160	35 - 50	1 / 4



GRILL



Förvärm den tomma ugnen i 5 minuter.



Grillning med maximal temperaturinställning.



(min.)



Rosta	Grill	1 - 3	5
Nötstek, vänd efter halva tiden	Grill	24 - 30	4

10. UNDERHÅLL OCH RENGÖRING



VARNING!

Se säkerhetsavsnitten.

10.1 Anmärkningar om rengöring



**Rengöringsme-
del**

Torka av framsidan av ugnen med en mjuk trasa med varmt vatten och mildt rengöringsme-
del.

Använd en rengöringslösning för att rengöra metalldelar.

Rengör fläckar med ett mildt rengöringsmedel.



**Används varje
dag**

Rengör ugnsutrymmet efter varje användningstillfälle. Fettansamling eller andra matrester
kan leda till eldsvåda.

Låt inte maten stå i ugnen längre än 20 minuter. Torka av ugnsutrymmet med en mjuk trasa
efter användning.



Tillbehör

Rengör alla ugnstillbehör efter varje användningstillfälle och låt dem torka. Använd en mjuk
trasa med varmt vatten och mildt rengöringsmedel. Diska inte tillbehören i diskmaskin.

Rengör inte tillbehör med nonstick-beläggning med ett rengöringsmedel med slip-effekt eller
vassa föremål.

10.2 Hur man tar bort: Ugnsstegar

Ta bort ugnsstegarna vid rengöring av
ugnen.

Steg 1 Stäng av ugnen och vänta tills den
har svalnat.

Steg 2 Dra först ut stegarnas främre del från
sidoväggen.

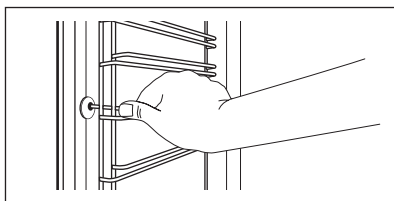

Steg 3 Dra ut stegen baktill från ugnssidan och ta bort den.

Steg 4 Sätt tillbaka ugnsstegarna i omvänd ordning.

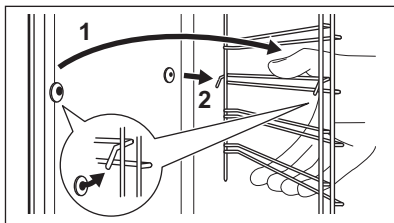

10.3 Hur man tar bort: Grill



VARNING!

Det finns risk för att du bränner dig.

Steg 1 Stäng av ugnen och vänta med att rengöra den tills den har svalnat. Ta ut ugnsstegarna.

Steg 2 Ta tag i grillens hörn. Dra den framåt mot fjädertrycket och ut ur de två hållarna. Grillen fälls ner.

Steg 3 Rengör ugnens tak med varmt vatten, en mjuk trasa och ett mildt rengöringsmedel. Låt det torka.

Steg 4 Sätt tillbaka grillen i omvänd ordning.

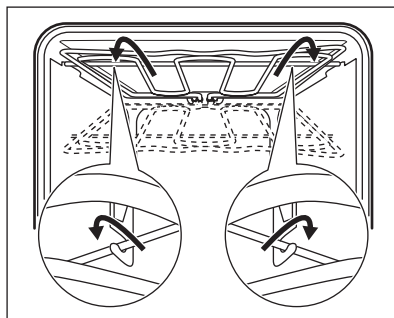

Steg 5 Sätt i ugnsstegarna.

10.4 Hur man tar bort och installerar: Luckan

Man kan ta loss och rengöra luckan och de inre glasrutorna. Antalet glaspaneler skiljer sig åt för olika modeller.



VARNING!

Luckan är tung.



FÖRSIKTIGHET!

Hantera glaset varsamt, särskilt runt den främre panelens kanter. Glaset kan gå sönder.

- Steg 1** Öppna luckan helt.
- Steg 2** Lyft och tryck in klämspärren (A) på de två gångjärnen till luckan.

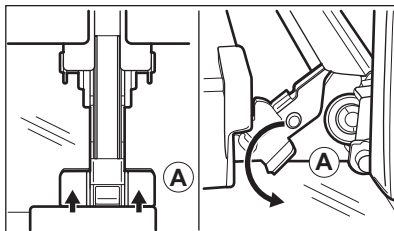

- Steg 3** Stäng ugnsluckan till den första öppna positionen (ungefär 70° vinkel). Håll i luckan på båda sidorna och dra den ut från ugnen i en uppåtgående vinkel. Lägg ner luckan med utsidan neråt på en mjuk handduk på ett stabilt underlag.

- Steg 4** Ta tag i lucklisten (B) på båda sidorna av luckans övre kant och tryck inåt för att frigöra klämlåset.

- Steg 5** Dra lucklisten framåt för att ta bort den.

- Steg 6** Håll glaset i överkanten ett i taget och dra dem uppåt och ut ur skenan.

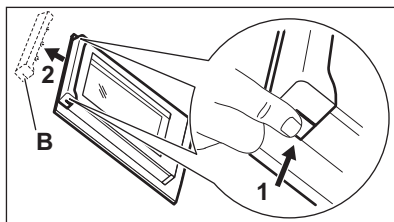

- Steg 7** Rengör glaset med vatten och tvål. Torka luckglaset noga. Diska inte glasskivorna i diskmaskin.

- Steg 8** Efter rengöring, utför stegen ovan i omvänd ordning.

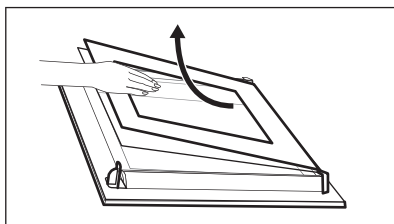

- Steg 9** Sätt i det mindre ugnsglaset först, därefter det större och sist luckan. Se till att glaset är korrekt och ordentligt införda, annars kan luckans yta bli överhettad.

10.5 Byte av: Lampa



WARNING!

Risk för elektrisk stöt!
Lampan kan vara het.

Innan du byter lampan:

Steg 1	Steg 2	Steg 3
Stäng av ugnen. Vänta tills ugnen är kall.	Koppla bort ugnen från eluttaget.	Lägg en trasa i botten av ugnsutrymmet.

Övre lampa

- Steg 1** Ta bort glasskyddet genom att vrida på det.

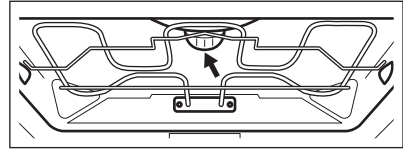

- Steg 2** Rengör lampglaset.
- Steg 3** Byt ut lampan mot en lämplig lampa som tål 300 °C.
- Steg 4** Sätt tillbaka lampglaset.

11. FELSÖKNING



VARNING!

Se säkerhetsavsnitten.

11.1 Om produkten inte fungerar ...

Om något inte finns i denna tabell, kontakta ett auktoriserat servicecenter.

Problem	Kontrollera att...
Ugnen värms inte upp.	Säkringarna har gått.
Lampan fungerar inte.	Glödlampan är trasig.

11.2 Serviceinformation

Kontakta din återförsäljare eller en auktoriserad serviceverkstad om du inte kan avhjälpa felet.

Information som kundtjänst behöver finns på märkplåten. Typskylten sitter på ugnsutrymmets yttre kant. Avlägsna inte märkskylten från ugnsutrymmet.

Vi rekommenderar att du antecknar uppgifterna här:

Modell (MOD.)

Produktnummer (PNC)

Serienummer (S.N.)

12. ENERGIEFFEKTIVITET

12.1 Produktinformation och produktinformationsblad*

Leverantörens namn	AEG
Modellbeskrivning	EEB230010M 940321361
Energieffektivitetsindex	95.3
Energieffektivitetsklass	A
Energiförbrukning med en standardrätt, över/undervärme	0.99 kWh/program

Energiförbrukning med en standardrätt, varmluft	0.81 kWh/program
Antal kaviteter	1
Värmekälla	Elektricitet
Ljudstyrka	71 l
Typ av ugn	Underbyggnadsugn
Massa	31.5 kg

* För Europeiska unionen enligt EU-förordningarna 65/2014 och 66/2014.
För Republiken Vitryssland enligt STB 2478-2017, bilaga G; STB 2477-2017, bilagorna A och B.
För Ukraina enligt 568/32020.

Energieffektivitetsklassen är inte tillämplig för Ryssland.

EN 60350-1 - Elektriska matlagningsprodukter för hushållsbruk - Del 1: Områden, ugnar, ångugnar och grillar - Funktionsprovning.

12.2 Energibesparing



Denna ugn har funktioner som möjliggör energibesparing under tillagningen.

Kontrollera att ugnsluckan är ordentligt stängd när ugnen är påslagen. Öppna inte luckan för ofta under tillagningen. Håll luckans tätningslist är ren och kontrollera att den sitter rätt och ordentligt fast.

Använd kokkärl i metall för högre energieffektivitet.

Om möjligt, undvik att förvärma ugnen före tillagning.

Gör så korta uppehåll som möjligt vid tillagning av flera rätter för samma tillfälle.

Tillagning med varmluft

Om möjligt, använd varmluftsfunktionen för att spara energi.

Restvärme

Om tillagningen tar längre tid än 30 minuter, sänk ugnstemperaturen med minst 3–10 minuter innan tillagningen avslutas. Tillagningen fortsätter med ugnens restvärme.

Använd restvärmen för att värma annan mat.

Varmhållning

Välj lägsta möjliga temperaturinställning för att använda restvärme och hålla maten varm.

Varmluft med fukt

Denna funktion används för att spara energi under tillagningen.

13. MILJÖSKYDD

Återvinn material med symbolen . Återvinn förpackningen genom att placera den i lämpligt kärl. Bidra till att skydda vår miljö och vår hälsa genom att återvinna avfall från elektriska och elektroniska produkter. Släng

inte produkter märkta med symbolen  med hushållsavfallet. Lämna in produkten på närmaste återvinningsstation eller kontakta kommunkontoret.

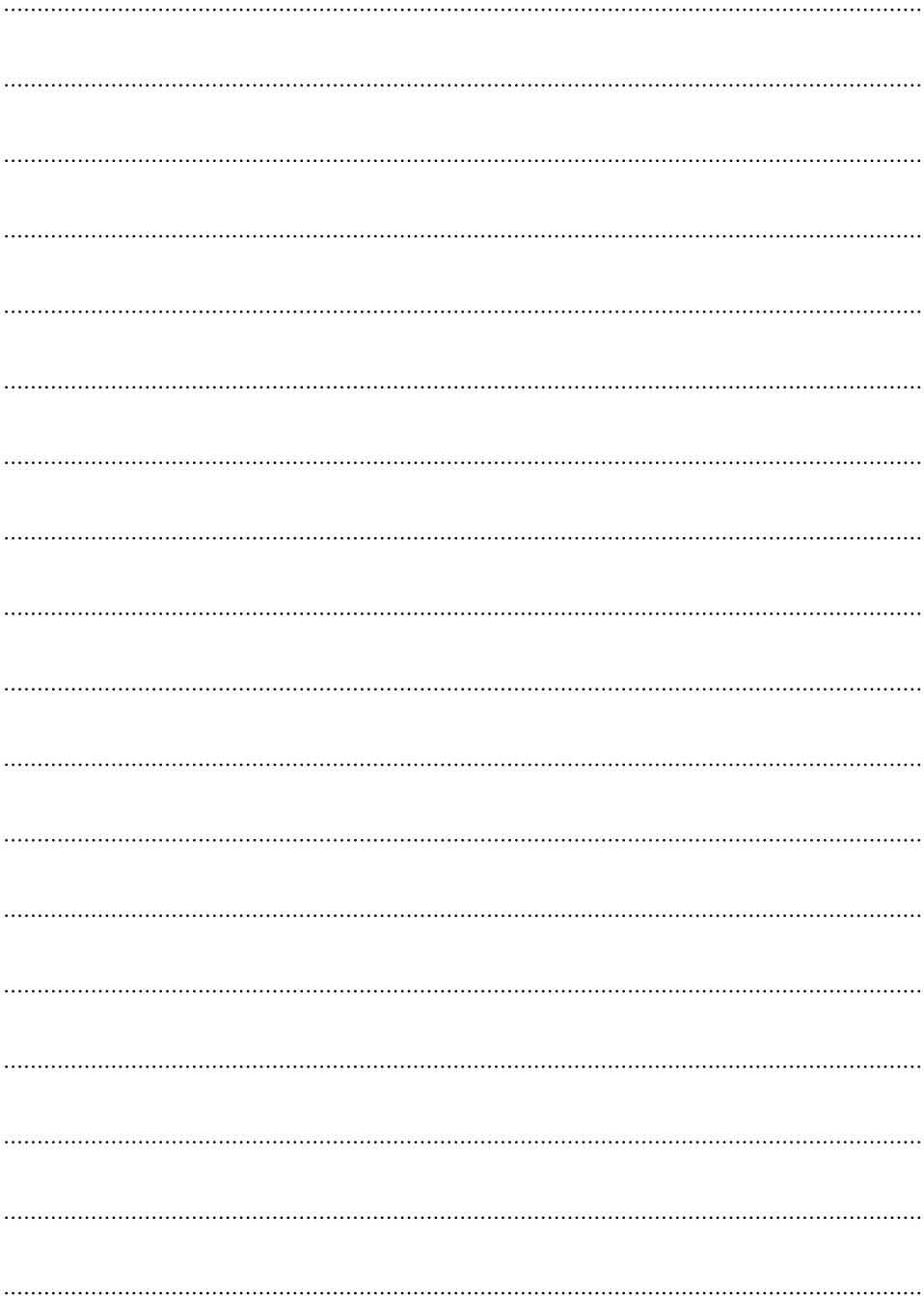

www.aeg.com/shop



867362713-A-062021



AEG