

EN

User Manual

USER MANUAL

Oven

ZOP37901

ZANUSSI

Contents

Safety information.....	2	Additional functions.....	10
Safety instructions.....	3	Hints and tips.....	11
Product description.....	6	Care and cleaning.....	19
Before first use.....	6	Troubleshooting.....	21
Daily use.....	7	Installation.....	23
Clock functions.....	9	Energy efficiency.....	25
Using the accessories.....	10		

Subject to change without notice.

Safety information

Before the installation and use of the appliance, carefully read the supplied instructions. The manufacturer is not responsible if an incorrect installation and use causes injuries and damages. Always keep the instructions with the appliance for future reference.

Children and vulnerable people safety

- This appliance can be used by children aged from 8 years and above and persons with reduced physical, sensory or mental capabilities or lack of experience and knowledge if they have been given supervision or instruction concerning use of the appliance in a safe way and understand the hazards involved.
- Do not let children play with the appliance.
- Keep all packaging away from children.
- Keep children and pets away from the appliance when it operates or when it cools down. Accessible parts are hot.
- If the appliance has a child safety device, we recommend you activate it.
- Cleaning and user maintenance shall not be made by children without supervision.
- Children of less than 3 years should be kept away unless continuously supervised.

General Safety

- Only a qualified person must install this appliance and replace the cable.

- Internally the appliance becomes hot when in operation. Do not touch the heating elements that are in the appliance. Always use oven gloves to remove or put in accessories or ovenware.
- Before maintenance cut the power supply.
- Ensure that the appliance is switched off before replacing the lamp to avoid the possibility of electric shock.
- Do not use a steam cleaner to clean the appliance.
- Do not use harsh abrasive cleaners or sharp metal scrapers to clean the glass door since they can scratch the surface, which may result in shattering of the glass.
- If the supply cord is damaged, it must be replaced by the manufacturer, its Authorised Service Centre or similarly qualified persons in order to avoid a hazard.
- Excess spillage must be removed before the pyrolytic cleaning. Remove all parts from the oven.
- To remove the shelf supports first pull the front of the shelf support and then the rear end away from the side walls. Install the shelf supports in the opposite sequence.
- The means for disconnection must be incorporated in the fixed wiring in accordance with the wiring rules.

Safety instructions

Installation



WARNING!

Only a qualified person must install this appliance.

- Remove all the packaging.
- Do not install or use a damaged appliance.
- Obey the installation instruction supplied with the appliance.
- Always be careful when you move the appliance because it is heavy. Always wear safety gloves.
- Do not pull the appliance by the handle.
- Keep the minimum distance from the other appliances and units.
- Make sure that the appliance is installed below and adjacent safe structures.
- The sides of the appliance must stay adjacent to appliances or to units with the same height.

Electrical connection



WARNING!

Risk of fire and electrical shock.

- All electrical connections should be made by a qualified electrician.
- The appliance must be earthed.
- Make sure that the electrical information on the rating plate agrees with the power supply. If not, contact an electrician.
- Always use a correctly installed shockproof socket.
- Do not use multi-plug adapters and extension cables.
- Make sure not to cause damage to the mains plug and to the mains cable. Should the mains cable need to be replaced, this must be carried out by our Authorised Service Centre.
- Do not let mains cables touch or come near the appliance door, especially when the door is hot.

- The shock protection of live and insulated parts must be fastened in such a way that it cannot be removed without tools.
- Connect the mains plug to the mains socket only at the end of the installation. Make sure that there is access to the mains plug after the installation.
- If the mains socket is loose, do not connect the mains plug.
- Do not pull the mains cable to disconnect the appliance. Always pull the mains plug.
- Use only correct isolation devices: line protecting cut-outs, fuses (screw type fuses removed from the holder), earth leakage trips and contactors.
- The electrical installation must have an isolation device which lets you disconnect the appliance from the mains at all poles. The isolation device must have a contact opening width of minimum 3 mm.
- Fully close the appliance door, before you connect the mains plug to the mains socket.
- This appliance complies with the E.E.C. Directives.

Use



WARNING!

Risk of injury, burns and electrical shock or explosion.

- Use this appliance in a household only.
- Do not change the specification of this appliance.
- Make sure that the ventilation openings are not blocked.
- Do not let the appliance stay unattended during operation.
- Deactivate the appliance after each use.
- Be careful when you open the appliance door while the appliance is in operation. Hot air can release.
- Do not operate the appliance with wet hands or when it has contact with water.
- Do not apply pressure on the open door.
- Do not use the appliance as a work surface or as a storage surface.
- Open the appliance door carefully. The use of ingredients with alcohol can cause a mixture of alcohol and air.
- Do not let sparks or open flames to come in contact with the appliance when you open the door.
- Do not put flammable products or items that are wet with flammable products in, near or on the appliance.



WARNING!

Risk of damage to the appliance.

- To prevent damage or discoloration to the enamel:
 - do not put ovenware or other objects in the appliance directly on the bottom.
 - do not put aluminium foil directly on the bottom of the appliance.
 - do not put water directly into the hot appliance.
 - do not keep moist dishes and food in the appliance after you finish the cooking.
 - be careful when you remove or install the accessories.
- Discoloration of the enamel has no effect on the performance of the appliance. It is not a defect in the sense of the warranty law.
- Use a deep pan for moist cakes. Fruit juices cause stains that can be permanent.
- This appliance is for cooking purposes only. It must not be used for other purposes, for example room heating.
- Always cook with the oven door closed.
- If the appliance is installed behind a furniture panel (e.g. a door) make sure the door is never closed when the appliance is in operation. Heat and moisture can build up behind a closed furniture panel and cause subsequent damage to the appliance, the housing unit or the floor. Do not close the furniture panel until the appliance has cooled down completely after use.

Care and cleaning



WARNING!

Risk of injury, fire, or damage to the appliance.

- Before maintenance, deactivate the appliance and disconnect the mains plug from the mains socket.
- Make sure the appliance is cold. There is the risk that the glass panels can break.
- Replace immediately the door glass panels when they are damaged. Contact the Authorised Service Centre.
- Be careful when you remove the door from the appliance. The door is heavy!
- Clean regularly the appliance to prevent the deterioration of the surface material.
- Remaining fat or food in the appliance can cause fire.
- Clean the appliance with a moist soft cloth. Only use neutral detergents. Do not use

abrasive products, abrasive cleaning pads, solvents or metal objects.

- If you use an oven spray, obey the safety instructions on the packaging.
- Do not clean the catalytic enamel (if applicable) with any kind of detergent.

Pyrolytic cleaning



Risk of Injury / Fires / Chemical Emissions (Fumes) in Pyrolytic Mode.

- Before carrying out a Pyrolytic self-cleaning function or the First Use please remove from the oven cavity:
 - any excess food residues, oil or grease spills / deposits.
 - any removable objects (including shelves, side rails etc., provided with the product) particularly any non-stick pots, pans, trays, utensils etc.
- Read carefully all the instructions for Pyrolytic cleaning.
- Keep children away from the appliance while the Pyrolytic cleaning is in operation. The appliance becomes very hot and hot air is released from the front cooling vents.
- Pyrolytic cleaning is a high temperature operation that can release fumes from cooking residues and construction materials, as such consumers are strongly advised to:
 - provide good ventilation during and after each Pyrolytic cleaning.
 - provide good ventilation during and after the first use at maximum temperature operation.
- Unlike all humans, some birds and reptiles can be extremely sensitive to potential fumes emitted during the cleaning process of all Pyrolytic Ovens.
 - Remove any pets (especially birds) from the vicinity of the appliance location during and after the Pyrolytic cleaning

and first use maximum temperature operation to a well ventilated area.

- Small pets can also be highly sensitive to the localized temperature changes in the vicinity of all Pyrolytic Ovens when the Pyrolytic self cleaning program is in operation.
- Non-stick surfaces on pots, pans, trays, utensils etc., can be damaged by the high temperature Pyrolytic cleaning operation of all Pyrolytic Ovens and can be also a source for low level harmful fumes.
- Fumes released from all Pyrolytic Ovens / Cooking Residues as described are not harmful to humans, including infants or persons with medical conditions.

Internal light

- The type of light bulb or halogen lamp used for this appliance is only for household appliances. Do not use it for house lighting.



WARNING!

Risk of electrical shock.

- Before replacing the lamp, disconnect the appliance from the power supply.
- Only use lamps with the same specifications.

Disposal



WARNING!

Risk of injury or suffocation.

- Disconnect the appliance from the mains supply.
- Cut off the mains cable and discard it.
- Remove the door catch to prevent children and pets to get closed in the appliance.

Service

- To repair the appliance contact an Authorised Service Centre.
- Use original spare parts only.

Product description

General overview

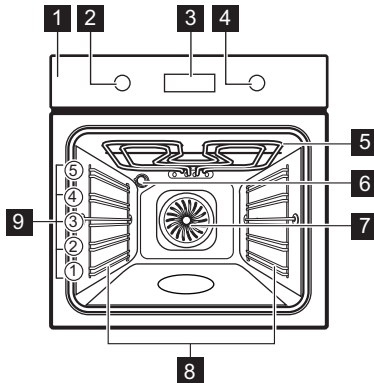

- 1 Control panel
- 2 Knob for the oven functions
- 3 Electronic programmer
- 4 Knob for the temperature
- 5 Heating element
- 6 Lamp
- 7 Fan
- 8 Shelf support, removable
- 9 Shelf positions

Accessories

- **Wire shelf**
For cookware, cake tins, roasts.
- **Grill- / Roasting pan**
To bake and roast or as pan to collect fat.

▪ Trivet

For roasting and grilling.



Use the trivet only with the Grill- / roasting pan.

Before first use



WARNING!

Refer to Safety chapters.

Initial Cleaning

Remove all accessories and removable shelf supports from the appliance.



Refer to "Care and cleaning" chapter.

Clean the appliance before first use. Put the accessories and the removable shelf supports back to their initial position.

Setting the time

After the first connection to the mains, all symbols in the display are on for some seconds. For the subsequent few seconds the display shows the software version.

After the software version goes off, the display shows **hr** and "**12:00**". "**12**" flashes.

1. Press **+** or **-** to set the current hour.

2. Press to confirm. This is necessary only when you set the time for the first time. Later the new time will be saved automatically after 5 seconds.

The display shows **min** and the set hour. "**00**" flashes.

3. Press **+** or **-** to set the current minutes.
4. Press to confirm. This is necessary only when you set the time for the first time. Later the new time will be saved automatically after 5 seconds.

The display shows the new time.



Changing the time

You can change the time of day only if the oven is off.

Press again and again until the indicator for the time of day flashes in the display. To set a new time, refer to "Setting the time".

Preheating

Preheat the empty appliance to burn off the remaining grease.

1. Set the function  and the maximum temperature.
2. Let the appliance operate for 1 hour.
3. Set the function  and the maximum temperature.

4. Let the appliance operate for 15 minutes. Accessories can become hotter than usual. The appliance can emit an odour and smoke. This is normal. Make sure that the airflow in the room is sufficient.

Daily use



WARNING!

Refer to Safety chapters.

Activating and deactivating the appliance













It depends on the model if your appliance has knob symbols, indicators or lamps:

- The indicator comes on when the oven heats up.
- The lamp comes on when the appliance operates.
- The symbol shows whether the knob controls the oven functions or the temperature.

1. Turn the knob for the oven functions to select an oven function.
2. Turn the knob for the temperature to select a temperature.
3. To deactivate the appliance turn the knobs for the oven functions and temperature to the off position.

Oven functions

Oven function		Application
	Off position	The appliance is off.
	True Fan Cooking	To bake on up to 3 shelf positions at the same time and to dry food. Set the temperature 20 - 40 °C lower than for Top / Bottom Heat.
	Top / Bottom Heat	To bake and roast food on 1 shelf position.
	Grilling	To grill flat food and to toast bread.
	Fast Grilling	To grill flat food in large quantities and to toast bread.
	Turbo Grilling	To roast larger meat joints or poultry with bones on 1 shelf position. Also to make gratins and to brown.

Oven function		Application
	Pizza Setting	To bake food on 1 shelf position for a more intensive browning and a crispy bottom. Set the temperature 20 - 40 °C lower than for Top / Bottom Heat.
	Meat	To prepare very tender and juicy roasts.
	Keep Warm	To keep food warm.
	Defrost	To defrost frozen food.
	Pyrolysis	To activate the automatic pyrolytic cleaning of the oven. This function burns off residual dirt in the oven.

Display

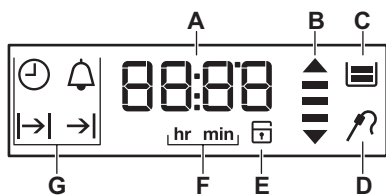

- A) Timer
- B) Heat-up and residual heat indicator
- C) Water drawer (selected models only)
- D) Core temperature sensor (selected models only)
- E) Door lock (selected models only)
- F) Hours / minutes
- G) Clock functions

Buttons

Button	Function	Description
—	MINUS	To set the time.
	CLOCK	To set a clock function.
+	PLUS	To set the time.





Heat-up indicator



When you activate an oven function, the bars in the display  come on one by one. The bars



show that the oven temperature increases or decreases.

Clock functions



Clock functions table



Clock function		Application
	TIME OF DAY	To set, change or check the time of day. Refer to "Setting the time".
	MINUTE MINDER	Use to set a countdown time (maximum 23 h 59 min). This function has no effect on the operation of the appliance. You can set the MINUTE MINDER at any time, also if the appliance is off.
	DURATION	To set how long the appliance operates. Use only when an oven function is set.
	END	To set when the appliance must deactivate. Use only when an oven function is set. You can use Duration and End at the same time (time delay), if the appliance is to be activate and deactivate automatically later.



 Press  again and again to switch between the clock functions.



 To confirm the settings of the clock functions, press  or wait 5 seconds for an automatic confirmation.



Setting the DURATION or END

1. Press  again and again until the display shows  or .

 or  flashes in the display.





2. Press  or  to set the values and press  to confirm.

For Duration  first you set the minutes and then the hours, for End  first you set the hours and then the minutes.



An acoustic signal sounds for 2 minutes after the time ends.  or  symbol and time setting flash in the display. The oven stops.



3. Turn the knob for the oven functions to the off position.

4. Press any button or open the oven door to stop the acoustic signal.

 If you press  when you set the hours for DURATION , the appliance goes to setting of the END  function.

Setting the MINUTE MINDER

1. Press  again and again until  and "00" flash in the display.

2. Press  or  to set the MINUTE MINDER.

First you set the seconds, then the minutes and then the hours.





At first, the time is calculated in minutes and seconds. When the time you set is longer than 60 minutes, the symbol **hr** comes on in the display.

The appliance now calculates the time in hours and minutes.

3. The MINUTE MINDER starts automatically after five seconds.

After 90% of the set time, an acoustic signal sounds.

4. When the set time ends, an acoustic signal sounds for two minutes. "00:00" and  flash in the display. Press any button or open the oven door to stop the acoustic signal.

 If you set the MINUTE MINDER when the DURATION  or END  function operates, the symbol  comes on in the display.

Count Up Timer

Use the Count Up Timer to monitor how long the oven operates. It is on immediately when the oven starts to heat.

To reset the Count Up Timer, press and hold **+** and **-**. The timer starts to count up again.

Using the accessories



WARNING!

Refer to Safety chapters.

Trivet and Grill- / Roasting pan



WARNING!

Be careful when you remove the accessories from a hot appliance. There is a risk of burns.

You can use the trivet to roast larger pieces of meat or poultry on one shelf position.

1. Put the trivet into the deep pan so that the supports of the wire shelf point up.

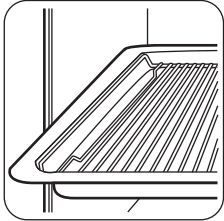

The Count Up Timer cannot be used with the functions: Duration **|→|**, End **→|**.

2. Put the deep pan into the oven on the necessary shelf position. You can use the trivet to grill flat dishes in large quantities and to toast.

1. Put the trivet into the deep pan so that the supports of the wire shelf point down.

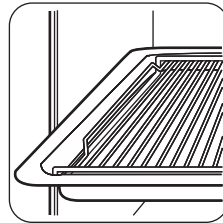

2. Put the deep pan into the oven on the necessary shelf position.

Additional functions

Using the Child Lock

The Child Lock prevents an accidental operation of the appliance.



If the Pyrolysis function operates, the door is locked. SAFE comes on in the display when you turn a knob or press a button.

1. Ensure the knob for the oven functions is in the off position.
2. Press and hold **⏸** and **+** at the same time for 2 seconds.

An acoustic signal sounds. SAFE comes on in the display.

To deactivate the Child Lock, repeat step 2.

Residual heat indicator

When you deactivate the appliance, the display shows the residual heat indicator **≡** if the temperature in the oven is more than 40 °C. Turn the knob for the temperature left or right to show the oven temperature.

Automatic Switch-off

For safety reasons the appliance deactivates automatically after some time if an oven function operates and you do not change any settings.

Temperature (°C)	Switch-off time (h)
30 - 115	12.5
120 - 195	8.5
200 - 245	5.5
250 - maximum	1.5

After an automatic switch-off, press any button to operate the appliance again.

-  The Automatic switch-off does not work with the functions: Light, Duration, End.

Hints and tips

-  **WARNING!**
Refer to Safety chapters.

-  The temperature and baking times in the tables are guidelines only. They depend on the recipes and the quality and quantity of the ingredients used.

General information

- The appliance has five shelf positions. Count the shelf positions from the bottom of the appliance floor.
- The appliance has a special system which circulates the air and constantly recycles the steam. With this system you can cook in a steamy environment and keep the food soft inside and crusty outside. It decreases the cooking time and energy consumption to a minimum.
- Moisture can condense in the appliance or on the door glass panels. This is normal. Always stand back from the appliance when you open the appliance door while cooking. To decrease the condensation, operate the appliance for 10 minutes before cooking.
- Clean the moisture after each use of the appliance.
- Do not put the objects directly on the appliance floor and do not put aluminium foil

Cooling fan

When the appliance operates, the cooling fan activates automatically to keep the surfaces of the appliance cool. If you deactivate the appliance, the cooling fan can continue to operate until the appliance cools down.

Safety thermostat

Incorrect operation of the appliance or defective components can cause dangerous overheating. To prevent this, the oven has a safety thermostat which interrupts the power supply. The oven activates again automatically when the temperature drops.

on the components when you cook. This can change the baking results and cause damage to the enamel.

Baking cakes

- Do not open the oven door before 3/4 of the set cooking time is up.
- If you use two baking trays at the same time, keep one empty level between them.

Cooking meat and fish

- Use a deep pan for very fatty food to prevent the oven from stains that can be permanent.
- Leave the meat for approximately 15 minutes before carving so that the juice does not seep out.
- To prevent too much smoke in the oven during roasting, add some water into the deep pan. To prevent the smoke condensation, add water each time after it dries up.

Cooking times

Cooking times depend on the type of food, its consistency, and volume.

Initially, monitor the performance when you cook. Find the best settings (heat setting, cooking time, etc.) for your cookware, recipes and quantities when you use this appliance.

Baking and roasting table

Cakes

Food	Top / Bottom Heat		True Fan Cooking		Time (min)	Comments
	Temperature (°C)	Shelf position	Temperature (°C)	Shelf position		
Whisked recipes	170	2	160	3 (2 and 4)	45 - 60	In a cake mould
Shortbread dough	170	2	160	3 (2 and 4)	20 - 30	In a cake mould
Buttermilk cheesecake	170	1	165	2	80 - 100	In a 26 cm cake mould
Apple cake (Apple pie) ¹⁾	170	2	160	2 (left and right)	80 - 100	In two 20 cm cake moulds on a wire shelf
Strudel	175	3	150	2	60 - 80	In a baking tray
Jam-tart	170	2	165	2 (left and right)	30 - 40	In a 26 cm cake mould
Sponge cake	170	2	150	2	40 - 50	In a 26 cm cake mould
Christmas cake / Rich fruit cake ¹⁾	160	2	150	2	90 - 120	In a 20 cm cake mould
Plum cake ¹⁾	175	1	160	2	50 - 60	In a bread tin
Small cakes - one level ¹⁾	170	3	150 - 160	3	20 - 30	In a baking tray
Small cakes - two levels ¹⁾	-	-	140 - 150	2 and 4	25 - 35	In a baking tray
Small cakes - three levels ¹⁾	-	-	140 - 150	1, 3 and 5	30 - 45	In a baking tray
Biscuits / pastry stripes - one level	140	3	140 - 150	3	25 - 45	In a baking tray
Biscuits / pastry stripes - two levels	-	-	140 - 150	2 and 4	35 - 40	In a baking tray

Food	Top / Bottom Heat		True Fan Cooking		Time (min)	Comments
	Temperature (°C)	Shelf position	Temperature (°C)	Shelf position		
Biscuits / pastry stripes - three levels	-	-	140 - 150	1, 3 and 5	35 - 45	In a baking tray
Meringues - one level	120	3	120	3	80 - 100	In a baking tray
Meringues - two levels ¹⁾	-	-	120	2 and 4	80 - 100	In a baking tray
Buns ¹⁾	190	3	190	3	12 - 20	In a baking tray
Eclairs - one level	190	3	170	3	25 - 35	In a baking tray
Eclairs - two levels	-	-	170	2 and 4	35 - 45	In a baking tray
Plate tarts	180	2	170	2	45 - 70	In a 20 cm cake mould
Rich fruit cake	160	1	150	2	110 - 120	In a 24 cm cake mould
Victoria sandwich ¹⁾	170	1	160	2 (left and right)	30 - 50	In a 20 cm cake mould

¹⁾ Preheat the oven for 10 minutes.

Bread and pizza

Food	Top / Bottom Heat		True Fan Cooking		Time (min)	Comments
	Temperature (°C)	Shelf position	Temperature (°C)	Shelf position		
White bread ¹⁾	190	1	190	1	60 - 70	1 - 2 pieces, 500 gr per piece
Rye bread	190	1	180	1	30 - 45	In a bread tin
Bread rolls ¹⁾	190	2	180	2 (2 and 4)	25 - 40	6 - 8 rolls in a baking tray
Pizza ¹⁾	230 - 250	1	230 - 250	1	10 - 20	In a baking tray or a deep pan

Food	Top / Bottom Heat		True Fan Cooking		Time (min)	Comments
	Temperature (°C)	Shelf position	Temperature (°C)	Shelf position		
Scones ¹⁾	200	3	190	3	10 - 20	In a baking tray

¹⁾ Preheat the oven for 10 minutes.

Flans

Food	Top / Bottom Heat		True Fan Cooking		Time (min)	Comments
	Temperature (°C)	Shelf position	Temperature (°C)	Shelf position		
Pasta flan	200	2	180	2	40 - 50	In a mould
Vegetable flan	200	2	175	2	45 - 60	In a mould
Quiches ¹⁾	180	1	180	1	50 - 60	In a mould
Lasagne ¹⁾	180 - 190	2	180 - 190	2	25 - 40	In a mould
Cannelloni ¹⁾	180 - 190	2	180 - 190	2	25 - 40	In a mould

¹⁾ Preheat the oven for 10 minutes.

Meat

Food	Top / Bottom Heat		True Fan Cooking		Time (min)	Comments
	Temperature (°C)	Shelf position	Temperature (°C)	Shelf position		
Beef	200	2	190	2	50 - 70	On a wire shelf
Pork	180	2	180	2	90 - 120	On a wire shelf
Veal	190	2	175	2	90 - 120	On a wire shelf
English roast beef, rare	210	2	200	2	50 - 60	On a wire shelf
English roast beef, medium	210	2	200	2	60 - 70	On a wire shelf
English roast beef, well done	210	2	200	2	70 - 75	On a wire shelf

Food	Top / Bottom Heat		True Fan Cooking		Time (min)	Comments
	Temperature (°C)	Shelf position	Temperature (°C)	Shelf position		
Shoulder of pork	180	2	170	2	120 - 150	With rind
Shin of pork	180	2	160	2	100 - 120	2 pieces
Lamb	190	2	175	2	110 - 130	Leg
Chicken	220	2	200	2	70 - 85	Whole
Turkey	180	2	160	2	210 - 240	Whole
Duck	175	2	220	2	120 - 150	Whole
Goose	175	2	160	1	150 - 200	Whole
Rabbit	190	2	175	2	60 - 80	Cut in pieces
Hare	190	2	175	2	150 - 200	Cut in pieces
Pheasant	190	2	175	2	90 - 120	Whole

Fish

Food	Top / Bottom Heat		True Fan Cooking		Time (min)	Comments
	Temperature (°C)	Shelf position	Temperature (°C)	Shelf position		
Trout / Sea bream	190	2	175	2	40 - 55	3 - 4 fish
Tuna fish / Salmon	190	2	175	2	35 - 60	4 - 6 fillets

Grilling

 Preheat the empty oven for 3 minutes before cooking.

Food	Quantity		Temperature (°C)	Time (min)		Shelf position
	Pieces	(g)		1st side	2nd side	
Fillet steaks	4	800	max.	12 - 15	12 - 14	4
Beef steaks	4	600	max.	10 - 12	6 - 8	4

Food	Quantity		Temperature (°C)	Time (min)		Shelf position
	Pieces	(g)		1st side	2nd side	
Sausages	8	-	max.	12 - 15	10 - 12	4
Pork chops	4	600	max.	12 - 16	12 - 14	4
Chicken (cut in 2)	2	1000	max.	30 - 35	25 - 30	4
Kebabs	4	-	max.	10 - 15	10 - 12	4
Breast of chicken	4	400	max.	12 - 15	12 - 14	4
Hamburger	6	600	max.	20 - 30	-	4
Fish fillet	4	400	max.	12 - 14	10 - 12	4
Toasted sandwiches	4 - 6	-	max.	5 - 7	-	4
Toast	4 - 6	-	max.	2 - 4	2 - 3	4

Turbo Grilling

Beef

Food	Quantity	Temperature (°C)	Time (min)	Shelf position
Roast beef or fillet, rare ¹⁾	per cm of thickness	190 - 200	5 - 6	1 or 2
Roast beef or fillet, medium ¹⁾	per cm of thickness	180 - 190	6 - 8	1 or 2
Roast beef or fillet, well done ¹⁾	per cm of thickness	170 - 180	8 - 10	1 or 2

¹⁾ Preheat the oven.

Pork

Food	Quantity (kg)	Temperature (°C)	Time (min)	Shelf position
Shoulder, neck, ham joint	1 - 1.5	160 - 180	90 - 120	1 or 2
Chop, spare rib	1 - 1.5	170 - 180	60 - 90	1 or 2
Meat loaf	0.75 - 1	160 - 170	50 - 60	1 or 2
Pork knuckle (pre-cooked)	0.75 - 1	150 - 170	90 - 120	1 or 2

Veal

Food	Quantity (kg)	Temperature (°C)	Time (min)	Shelf position
Roast veal	1	160 - 180	90 - 120	1 or 2
Knuckle of veal	1.5 - 2	160 - 180	120 - 150	1 or 2

Lamb

Food	Quantity (kg)	Temperature (°C)	Time (min)	Shelf position
Leg of lamb, roast lamb	1 - 1.5	150 - 170	100 - 120	1 or 2
Saddle of lamb	1 - 1.5	160 - 180	40 - 60	1 or 2

Poultry

Food	Quantity (kg)	Temperature (°C)	Time (min)	Shelf position
Poultry portions	0.2 - 0.25 each	200 - 220	30 - 50	1 or 2
Chicken, half	0.4 - 0.5 each	190 - 210	35 - 50	1 or 2
Chicken, poulard	1 - 1.5	190 - 210	50 - 70	1 or 2
Duck	1.5 - 2	180 - 200	80 - 100	1 or 2
Goose	3.5 - 5	160 - 180	120 - 180	1 or 2
Turkey	2.5 - 3.5	160 - 180	120 - 150	1 or 2
Turkey	4 - 6	140 - 160	150 - 240	1 or 2

Fish (steamed)

Food	Quantity (kg)	Temperature (°C)	Time (min)	Shelf position
Whole fish	1 - 1.5	210 - 220	40 - 60	1 or 2

Defrost

Food	Quantity (g)	Defrosting time (min)	Further defrosting time (min)	Comments
Chicken	1000	100 - 140	20 - 30	Place the chicken on an up-turned saucer placed on a large plate. Turn halfway through.
Meat	1000	100 - 140	20 - 30	Turn halfway through.

Food	Quantity (g)	Defrosting time (min)	Further defrosting time (min)	Comments
Meat	500	90 - 120	20 - 30	Turn halfway through.
Trout	150	25 - 35	10 - 15	-
Strawberries	300	30 - 40	10 - 20	-
Butter	250	30 - 40	10 - 15	-
Cream	2 x 200	80 - 100	10 - 15	Cream can also be whipped when still slightly frozen in places.
Gateau	1400	60	60	-

Drying - True Fan Cooking

- Cover trays with grease proof paper or baking parchment.
- For a better result, stop the oven halfway through the drying time, open the door and

let it cool down for one night to complete the drying.

Vegetables

Food	Temperature (°C)	Time (h)	Shelf position	
			1 position	2 positions
Beans	60 - 70	6 - 8	3	1 / 4
Peppers	60 - 70	5 - 6	3	1 / 4
Vegetables for sour	60 - 70	5 - 6	3	1 / 4
Mushrooms	50 - 60	6 - 8	3	1 / 4
Herbs	40 - 50	2 - 3	3	1 / 4

Fruit

Food	Temperature (°C)	Time (h)	Shelf position	
			1 position	2 positions
Plums	60 - 70	8 - 10	3	1 / 4
Apricots	60 - 70	8 - 10	3	1 / 4
Apple slices	60 - 70	6 - 8	3	1 / 4
Pears	60 - 70	6 - 9	3	1 / 4

Care and cleaning



WARNING!

Refer to Safety chapters.

Notes on cleaning

- Clean the front of the appliance with a soft cloth with warm water and a cleaning agent.
- To clean metal surfaces, use a usual cleaning agent.
- Clean the appliance interior after each use. Fat accumulation or other food remains may result in a fire. The risk is higher for the grill pan.
- Clean stubborn dirt with a special oven cleaner.
- Clean all accessories after each use and let them dry. Use a soft cloth with warm water and a cleaning agent.
- If you have nonstick accessories, do not clean them using aggressive agents, sharp-edged objects or a dishwasher. It can cause damage to the nonstick coating.

Stainless steel or aluminium appliances



Clean the oven door with a wet sponge only. Dry it with a soft cloth. Do not use steel wool, acids or abrasive materials as they can damage the oven surface. Clean the oven control panel with the same precautions.

Removing the shelf supports

To clean the oven, remove the shelf supports.

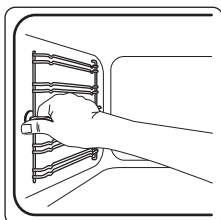

- 1 Pull the front of the shelf support away from the side wall.

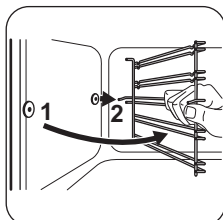

- 2 Pull the rear end of the shelf support away from the side wall and remove it.

Install the shelf supports in the opposite sequence.

Pyrolysis



CAUTION!

Remove all accessories and removable shelf supports.



Do not start the Pyrolysis if you did not fully close the oven door. In some models, the display shows "C3" when this error occurs.





WARNING!

The appliance becomes very hot. There is a risk of burns.



CAUTION!

If there are other appliances installed in the same cabinet, do not use them at the same time as the Pyrolysis function. It can cause damage to the appliance.

1. Remove the worst dirt manually.
2. Clean the inner side of the door with hot water, so that the residues do not burn from the hot air.
3. Set the Pyrolysis function. Refer to "Oven functions".
4. When  flashes, press  or  to set the necessary procedure:

Option	Description
P1	If the oven is not very dirty. Time of the procedure: 1 h.
P2	If you cannot easily remove the dirt. Time of the procedure: 1 h 30 min.

After 2 seconds the procedure starts. You can use the End function to delay the start of the cleaning procedure.

During the Pyrolysis the oven lamp is off.

5. When the oven is at its set temperature, the door locks. The display shows the symbol

 and the bars of the heat indicator until the door unlocks.

To stop Pyrolysis before it is completed, turn the knob for the oven functions to the off position.

- When Pyrolysis is completed, the display shows the time of day. The oven door stays locked.
- When the appliance is cool again, an acoustic signal sounds and the door unlocks.

Cleaning reminder

To remind you that the Pyrolysis is necessary, PYR flashes in the display for 10 seconds after each activation and deactivation of the appliance.

The cleaning reminder goes out:

- after the end of the Pyrolysis function.
- if you press \oplus and \ominus at the same time while PYR flashes in the display.

Cleaning the oven door

The oven door has three glass panels. You can remove the oven door and the internal glass panels to clean them.

 The oven door can close if you try to remove the glass panels before you remove the oven door.

 **CAUTION!** Do not use the appliance without the glass panels.

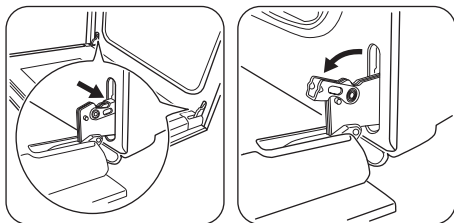

- Open the door fully and hold the two door hinges.
- Lift and turn the levers on the two hinges.

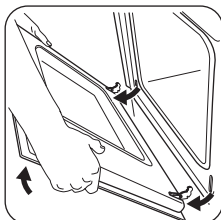

- Close the oven door halfway to the first opening position. Then pull forward and remove the door from its seat.

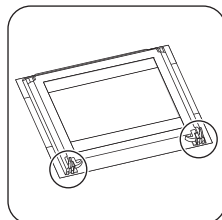

- Put the door on a soft cloth on a stable surface.

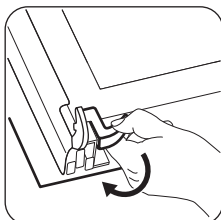

- Release the locking system to remove the glass panels.

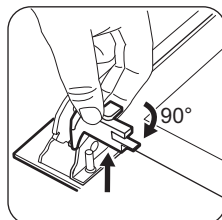

- Turn the two fasteners by 90° and remove them from their seats.

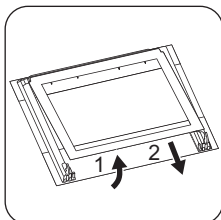

- First lift carefully and then remove the glass panels one by one. Start from the top panel.

Clean the glass panels with water and soap. Dry the glass panels carefully.

When the cleaning is completed, install the glass panels and the oven door. Do the above steps in the opposite sequence.

Make sure that you put the glass panels (A and B) back in the correct sequence. The middle panel (B) has a decorative frame. The screen-printing zone must face the inner side of the door. Make sure that after the installation the surface of the glass panel frame (B) on the

screen-printing zones is not rough when you touch it.

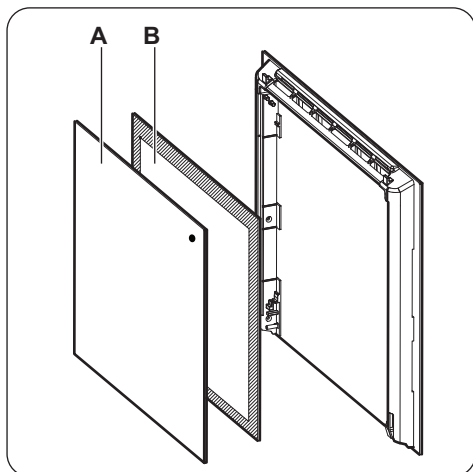

Make sure that you install the middle panel of glass in the seats correctly.

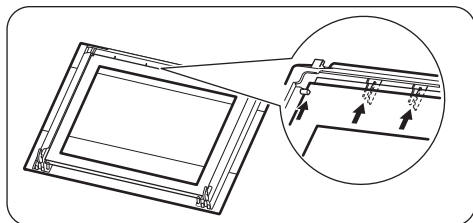

Replacing the lamp

Put a cloth on the bottom of the interior of the appliance. It prevents damage to the lamp glass cover and the cavity.

Troubleshooting



WARNING!

Refer to Safety chapters.



WARNING!

Danger of electrocution! Disconnect the fuse before you replace the lamp.

The lamp and the lamp glass cover can be hot.



CAUTION!

Always hold the halogen lamp with a cloth to prevent grease residue from burning on the lamp.

1. Deactivate the appliance.
2. Remove the fuses from the fuse box or deactivate the circuit breaker.

The back lamp



1. Turn the lamp glass cover counterclockwise to remove it.
2. Clean the glass cover.
3. Replace the lamp with a suitable 300 °C heat-resistant lamp.
4. Install the glass cover.

The side lamp

1. Remove the left shelf support to get access to the lamp.
2. Use a narrow, blunt object (e.g. a teaspoon) to remove the glass cover.
3. Clean the glass cover.
4. Replace the lamp with a suitable 300 °C heat-resistant lamp.
5. Install the glass cover.
6. Install the left shelf support.

What to do if...

Problem	Possible cause	Remedy
You cannot activate or operate the oven.	The oven is not connected to an electrical supply or it is connected incorrectly.	Check if the oven is correctly connected to the electrical supply (refer to the connection diagram if available).
The oven does not heat up.	The oven is deactivated.	Activate the oven.
The oven does not heat up.	The clock is not set.	Set the clock.
The oven does not heat up.	The necessary settings are not set.	Make sure that the settings are correct.
The oven does not heat up.	The automatic switch-off is activated.	Refer to "Automatic switch-off".
The oven does not heat up.	The Child Lock is on.	Refer to "Using the Child Lock".
The oven does not heat up.	The fuse is released.	Make sure that the fuse is the cause of the malfunction. If the fuse releases again and again, contact a qualified electrician.
The lamp does not operate.	The lamp is defective.	Replace the lamp.
It takes too long to cook the dishes or they cook too quickly.	The temperature is too low or too high.	Adjust the temperature if necessary. Follow the advice in the user manual.
Steam and condensation settle on the food and in the cavity of the oven.	You left the dish in the oven for too long.	Do not leave the dishes in the oven for longer than 15 - 20 minutes after the cooking process ends.
The display shows "C3".	The cleaning function does not operate. You did not fully close the door, or the door lock is defective.	Fully close the door.
The display shows "F102".	<ul style="list-style-type: none"> ▪ You did not fully close the door. ▪ The door lock is defective. 	<ul style="list-style-type: none"> ▪ Fully close the door. ▪ Deactivate the oven with the house fuse or the safety switch in the fuse box and activate it again. ▪ If the display shows "F102" again, contact the Customer Care Department.

Problem	Possible cause	Remedy
The display shows an error code that is not in this table.	There is an electrical fault.	<ul style="list-style-type: none"> ▪ Deactivate the oven with the house fuse or the safety switch in the fuse box and activate it again. ▪ If the display shows the error code again, contact the Customer Care Department.
The appliance is activated and does not heat up. The fan does not operate. The display shows "Demo".	The demo mode is activated.	<ol style="list-style-type: none"> 1. Deactivate the oven. 2. Press and hold the button . 3. When an acoustic signal sounds, turn the knob for the oven functions clockwise to the first function. "Demo" flashes in the display. 4. Turn the knob for the oven functions to the off position. 5. Release the button . 6. Turn the knob for the temperature clockwise and hold it for three seconds. The acoustic signal sounds three times. The demo mode is deactivated.

Service data

If you cannot find a solution to the problem yourself, contact your dealer or an Authorised Service Centre.

The necessary data for the service centre is on the rating plate. The rating plate is on the front frame of the appliance cavity. Do not remove the rating plate from the appliance cavity.

We recommend that you write the data here:

Model (MOD.)
Product number (PNC)
Serial number (S.N.)

Installation



WARNING!

Refer to Safety chapters.

Building In

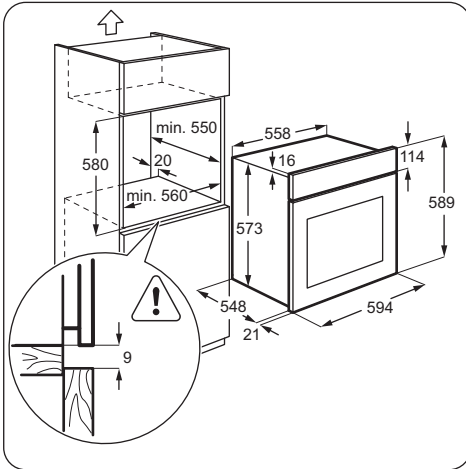
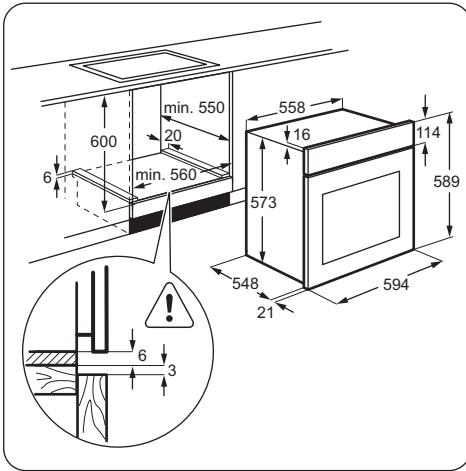

Applicable types of cables for UK only

Connection via	Min. size cable / flex	Cable / flex type	Fuse
Oven Control Circuit	2,5 mm ²	PVC / PVC twin and earth	15 A min. 20 A max.



Securing the appliance to the cabinet

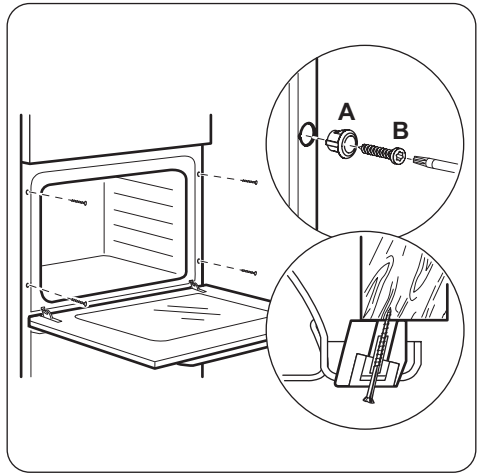

Electrical installation

i The manufacturer is not responsible if you do not follow the safety precautions from the Safety chapters.

This appliance is supplied without a main plug and a main cable.

Applicable types of cables for Europe:

- Minimum size Cable / flex: 1,5 mm²
- Cable / flex type: H07 RN-F, H05 RN-F, H05 RRF, H05 VV-F, H05 V2V2-F (T90), H05 BB-F

Energy efficiency

Product Fiche and information according to EU 65-66/2014

Supplier's name	Zanussi
Model identification	ZOP37901XK
Energy Efficiency Index	100.0
Energy efficiency class	A
Energy consumption with a standard load, conventional mode	0.93 kWh/cycle
Energy consumption with a standard load, fan-forced mode	0.85 kWh/cycle
Number of cavities	1
Heat source	Electricity
Volume	72 l
Type of oven	Built-In Oven
Mass	34.1 kg

EN 60350-1 - Household electric cooking appliances - Part 1: Ranges, ovens, steam ovens and grills - Methods for measuring performance.

Energy saving

The appliance contains features which help you save energy during everyday cooking.

▪ General hints

- Make sure that the oven door is closed properly when the appliance operates and keep it closed as much as possible during the cooking.
- Use metal dishes to improve the energy saving.
- When possible, put the food inside the oven without heating it up.
- When the cooking duration is longer than 30 minutes, reduce the oven

temperature to minimum, 3 - 10 minutes before the end of the cooking time, depending on the duration of the cooking. The residual heat inside the oven will continue to cook.

- Use the residual heat to warm up other foods.
- **Cooking with fan** - when possible, use the cooking functions with fan to save energy.
- **Residual heat**
 - In some oven functions if a programme with time selection (Duration, End) is activated and the cooking time is longer than 30 minutes, the heating elements deactivate automatically 10% earlier. The fan and lamp continue to operate.
- **Keep food warm** - if you want to use the residual heat to keep the meal warm, choose the lowest possible temperature setting. The display shows the residual heat temperature.

ENVIRONMENT CONCERNS

Recycle the materials with the symbol . Put the packaging in applicable containers to recycle it. Help protect the environment and human health and to recycle waste of electrical and electronic appliances. Do not dispose

appliances marked with the symbol  with the household waste. Return the product to your local recycling facility or contact your municipal office.



www.zanussi.com/shop



867318793-A-182015