



## CONTENTS

1. SAFETY INFORMATION.....	3
2. SAFETY INSTRUCTIONS.....	4
3. PRODUCT DESCRIPTION.....	6
4. CONTROL PANEL.....	7
5. PROGRAMMES .....	9
6. CONSUMPTION VALUES.....	11
7. OPTIONS.....	12
8. SETTINGS.....	14
9. BEFORE FIRST USE.....	15
10. DAILY USE.....	15
11. HINTS AND TIPS.....	19
12. CARE AND CLEANING.....	20
13. TROUBLESHOOTING.....	24
14. TECHNICAL DATA.....	26

## WE'RE THINKING OF YOU

Thank you for purchasing an Electrolux appliance. You've chosen a product that brings with it decades of professional experience and innovation. Ingenious and stylish, it has been designed with you in mind. So whenever you use it, you can be safe in the knowledge that you'll get great results every time.

Welcome to Electrolux.

**Visit our website for:**



Get usage advice, brochures, trouble shooter, service information:  
**[www.electrolux.com/webselfservice](http://www.electrolux.com/webselfservice)**



Register your product for better service:  
**[www.registerelectrolux.com](http://www.registerelectrolux.com)**



Buy Accessories, Consumables and Original spare parts for your appliance:  
**[www.electrolux.com/shop](http://www.electrolux.com/shop)**

## CUSTOMER CARE AND SERVICE

Always use original spare parts.

When contacting our Authorised Service Centre, ensure that you have the following data available: Model, PNC, Serial Number.

The information can be found on the rating plate.

 Warning / Caution-Safety information

 General information and tips

 Environmental information

Subject to change without notice.

## 1. ⚠ SAFETY INFORMATION

Before the installation and use of the appliance, carefully read the supplied instructions. The manufacturer is not responsible for any injuries or damages that are the result of incorrect installation or usage. Always keep the instructions in a safe and accessible location for future reference.

### 1.1 Children and vulnerable people safety

- This appliance can be used by children aged from 8 years and above and persons with reduced physical, sensory or mental capabilities or lack of experience and knowledge if they have been given supervision or instruction concerning the use of the appliance in a safe way and understand the hazards involved.
- Do not let children play with the appliance.
- Children aged 3 years and under must be kept away from this appliance when it is in operation at all times.
- Keep all packaging away from children and dispose of it appropriately.
- Keep detergents away from children.
- Keep children and pets away from the appliance when the door is open.
- If the appliance has a child safety device, this should be activated.
- Children shall not carry out cleaning and user maintenance of the appliance without supervision.

### 1.2 General Safety

- Do not change the specification of this appliance.
- Do not exceed the maximum load of 7 kg (refer to the "Programme chart" chapter).
- The operating water pressure at the water entry point from the outlet connection must be between 0.5 bar (0.05 MPa) and 8 bar (0.8 MPa).
- The ventilation opening in the base must not be covered by a carpet, mat, or any floor covering.

- The appliance must be connected to the water mains using the new supplied hose sets, or other new hose sets supplied by the Authorised Service Centre.
- Old hose sets must not be reused.
- If the mains power supply cable is damaged, it must be replaced by the manufacturer, its Authorised Service Centre or similarly qualified persons to avoid an electrical hazard.
- Before any maintenance operation, deactivate the appliance and disconnect the mains plug from the socket.
- Do not use high pressure water sprays and/or steam to clean the appliance.
- Clean the appliance with a moist cloth. Use only neutral detergents. Do not use abrasive products, abrasive cleaning pads, solvents or metal objects.

## 2. SAFETY INSTRUCTIONS

### 2.1 Installation

- Remove all the packaging and the transit bolts.
- Keep the transit bolts in a safe place. If the appliance is to be moved in future they must be reattached to lock the drum to prevent internal damage.
- Always take care when moving the appliance as it is heavy. Always use safety gloves and enclosed footwear.
- Do not install or use a damaged appliance.
- Follow the installation instruction supplied with the appliance.
- Do not install or use the appliance where the temperature can be less than 0°C or where it is exposed to the weather.
- The floor area where the appliance is to be installed must be flat, stable, heat resistant and clean.
- Make sure that there is air circulation between the appliance and the floor.
- Do not install the appliance directly over the floor drain.
- Adjust the feet to have the necessary space between the appliance and the flooring.

- Do not install the appliance where the appliance door cannot be fully opened.
- Do not put a container to collect possible water leakage under the appliance. Contact the Authorised Service Centre to ensure which accessories can be used.

### 2.2 Electrical connection

- The appliance must be earthed.
- Always use a correctly installed shockproof socket.
- Make sure that the parameters on the rating plate are compatible with the electrical ratings of the mains power supply.
- Do not use multi-plug adapters and extension cables.
- Make sure not to cause damage to the mains plug and to the mains cable. Should the mains cable need to be replaced, this must be carried out by our Authorised Service Centre.
- Connect the mains plug to the mains socket only at the end of the installation. Make sure that there is

access to the mains plug after the installation.

- Do not touch the mains cable or the mains plug with wet hands.
- Do not pull the mains cable to disconnect the appliance. Always pull the mains plug.
- This appliance complies with the E.E.C. Directives.

## 2.3 Water connection

- Do not cause damage to the water hoses.
- Before connection to new pipes, pipes not used for a long time, where repair work has been carried out or new devices fitted (water meters, etc.), let the water flow until it is clean and clear.
- Ensure that there are no visible water leaks during and after the first use of the appliance.

## 2.4 Use



### **WARNING!**

Risk of injury, electrical shock, fire, burns or damage to the appliance.

- This appliance is for household use only.
- Follow the safety instructions on the detergent packaging.
- Do not put flammable products or items that are wet with flammable products in, near or on the appliance.

- Make sure that all metal objects are removed from the laundry.
- Do not wash fabrics which are heavily soiled with oil, grease or other greasy substances. It can damage rubber parts of the washing machine. Prewash such fabrics by hand before loading them into the washing machine.
- Do not touch the glass door while a programme is in operation. The glass can get hot.

## 2.5 Service

- To repair the appliance contact an Authorised Service Centre.
- Use original spare parts only.

## 2.6 Disposal



### **WARNING!**

Risk of injury or suffocation.

- Disconnect the appliance from the mains electrical and water supplies.
- Cut off the mains electrical cable close to the appliance and dispose of it.
- Remove the door catch to prevent children or pets from becoming trapped in the drum.
- Dispose of the appliance in accordance with local requirements for the disposal of Waste Electrical and Electronic Equipment (WEEE).

## 3. PRODUCT DESCRIPTION

### 3.1 Appliance overview

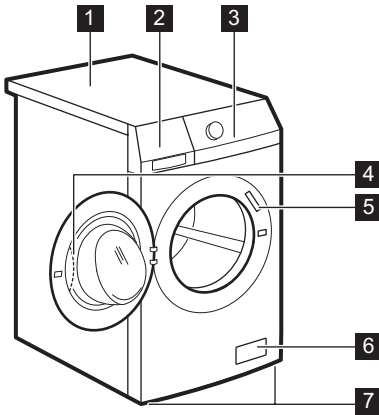

- 1 Worktop
- 2 Detergent dispenser
- 3 Control panel
- 4 Door handle
- 5 Rating plate
- 6 Drain pump filter
- 7 Feet for levelling the appliance

### 3.2 How to activate the child safety device

This device prevents children or pets from being closed in the drum.

Turn the device clockwise, until the groove is horizontal.  
You cannot close the door.

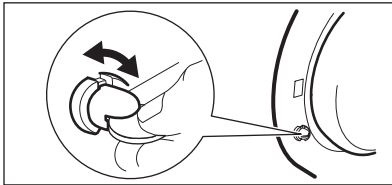

To close the door, turn the device anticlockwise until the groove is vertical.

### 3.3 Fixing plate kit (4055171146)

Available from your authorised dealer.









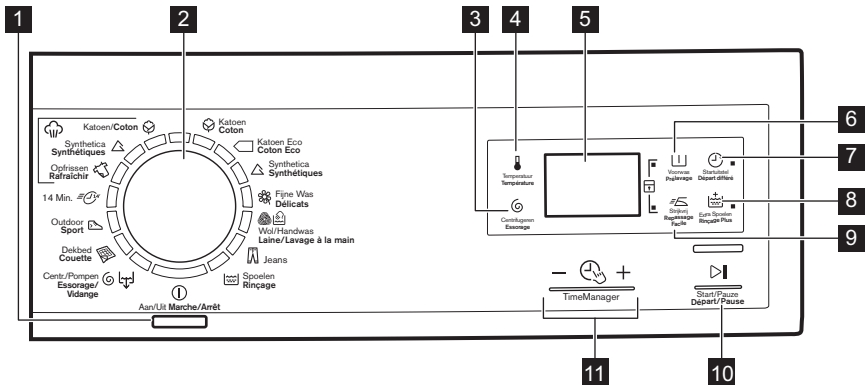

If you install the appliance on a plinth, secure the appliance in the fixing plates.

Read carefully the instructions supplied with the accessory.

## 4. CONTROL PANEL

### 4.1 Control panel description



- 1** On Off button  (Aan/Uit Marche/Arrêt)
- 2** Programme knob
- 3** Spin reduction touchpad  (Centrifugeren - Essorage)
- 4** Temperature touchpad  (Température - Température)
- 5** Display
- 6** Prewash touchpad  (Voorwas - Prélavage)
- 7** Delay start touchpad  (Startuitstel - Départ différé)
- 8** Extra rinse touchpad  (Extra Spoelen - Rinçage Plus)
- 9** Easy iron touchpad  (Strijkvrij - Repassage Facile)
- 10** Start/Pause touchpad  (Start/Pause - Départ/Pause)
- 11** Time Manager touchpads   (TimeManager)

## 4.2 Display

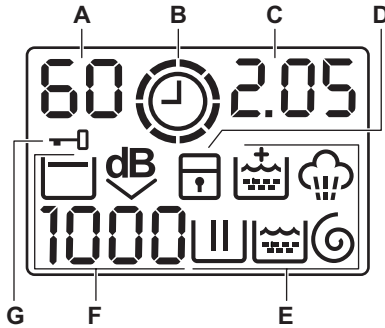















- A.** The Temperature area:
- 88: Temperature indicator
  - : Cold water indicator
- B.** ⌚: Time Manager indicator.
- C.** The time area:
- 1.25: the programme duration
  - 2h: the delay start
  - E20: the alarm codes
  - Err: the message of error
  - 0: the programme is completed.
- D.** 🛡️: the child safety lock indicator.
- E.** Washing indicators:
- 🧺: the washing phase
  - 🧼: the rinses phase
  - 🌀: the spin phase
  - 🌫️: the steam phase
  - 🚰: the Extra rinse permanent option.
- F.** The spin area:
- 1888: the Spin speed indicator
  - : the No Spin indicator
  - 🛑: the Rinse Hold indicator
  - 🔇: the Extra Silent indicator.
- G.** 🔒: the Door locked indicator
- Indicator on: the appliance door is locked. You cannot open the door.
  - Indicator flashing: the appliance door is opening. Wait a few minutes until the door unlocks.
  - Indicator off: the appliance door is unlocked. You can open the door.



## 5. PROGRAMMES

### 5.1 Programme Chart

Programme Temperature range	Maximum load Maximum spin speed	Programme description (Type of load and soil level)
<b>Washing programmes</b>		
 Katoen/Coton 90°C - Cold	7 kg 1400 rpm	<b>White cotton and coloured cotton.</b> Normal soil and light soil.
 Katoen Eco/Coton Eco <sup>1)</sup> 60°C - 40°C	7 kg 1400 rpm	<b>White cotton and fast-coloured cotton.</b> Normal soil. The energy consumption decreases and the time of the washing programme is extended.
 Synthetica/Synthétiques 60°C - Cold	3,5 kg 1200 rpm	<b>Synthetic items or mixed fabric items.</b> Normal soil.
 Fijne was/Délicats 40°C - Cold	3,5 kg 1200 rpm	<b>Delicate fabrics such as acrylics, viscose and mixed fabrics requiring a mild washing.</b> Normal soil.
 Wol/Handwas - Laine/Lavage à la main 40°C - Cold	1,5 kg 1200 rpm	<b>Machine washable wool, hand washable wool and other fabrics with «hand washing» care symbol<sup>2)</sup>.</b>
 Jeans 60°C - Cold	7 kg 1200 rpm	<b>Items in denim and jersey.</b> Also for dark coloured items.
 Spoelen/Rinçage	7 kg 1400 rpm	To rinse and spin the laundry. <b>All fabrics</b> , except woollens and very delicate fabrics. Reduce the spin speed accordingly to the type of laundry.
 Centrif./Pompen - Essorage/Vidange <sup>3)</sup>	7 kg 1400 rpm	To spin the laundry and to drain the water in the drum. <b>All fabrics, except woollens and delicate fabrics.</b>
 Dekbed/Couette 60°C - 30°C	2 kg 800 rpm	Special programme for one <b>synthetic blanket, duvet, bedspread</b> and so on.
 Outdoor/Sport 30°C	2,5 kg 800 rpm	<b>Synthetic and delicate items.</b> Light soil items or items to refresh.
 14 Min. 30°C	1,5 kg 800 rpm	<b>Synthetic and mixed fabric</b> items. Light soil and items to freshen up.

Programme Temperature range	Maximum load Maximum spin speed	Programme description (Type of load and soil level)
<b>Steam programmes<sup>4)</sup></b>		
<p>Steam can be used for dried, washed or worn once laundry. These programmes can reduce creases and odours and make your laundry softer.</p> <p>Do not use any detergent. If necessary, remove stains by washing or using localized stain removal.</p> <p>Steam programmes do not perform any hygienic cycle.</p> <p>Do not set a Steam programme with these types of items:</p> <ul style="list-style-type: none"> <li>• Items to be washed at a temperature lower than 40°C.</li> <li>• Items where it is not specified on the care label as being suitable for tumble drying.</li> <li>• All items with plastic, metal, wooden parts or alike.</li> </ul>		
 Oprissen/Rafrâichir	1,5 kg	Steam programme for <b>cotton and synthetic items</b> . This cycle removes odours from the laundry <sup>5)</sup> .
 Synthetica/Synthétiques	1,5 kg	Steam programme for <b>synthetic items</b> . This cycle helps to dewrinkle the laundry.
 Katoen/Coton	1,5 kg	Steam programme for <b>cottons</b> . This cycle helps to dewrinkle the laundry.



















**1) Standard programmes for the Energy Label consumption values.** According to regulation 1061/2010, these programmes are respectively the «Standard 60°C cotton programme» and the «Standard 40°C cotton programme». They are the most efficient programmes in terms of combined energy and water consumption for washing normally soiled cotton laundry.



The water temperature of the washing phase may differ from the temperature declared for the selected programme.

- 2) During this cycle the drum rotates slowly to ensure a gentle wash. It can seem that the drum doesn't rotate or doesn't rotate properly, but this is normal for this programme.
- 3) Set the spin speed. Make sure it is suitable for the type of fabric being washed. If you set the No Spin option then only the drain phase is available.
- 4) If you set a Steam programme with dried laundry, at the end of the cycle the laundry could be humid. It is better to expose the items to the fresh air for about 10 minutes to let the humidity dry. When the programme is completed, quickly remove the laundry from the drum. After a steam cycle, items may be ironed however with less effort.
- 5) Steam does not remove animal odours.

### Programme options compatibility

Programme								
	■	■	■	■	■	■	■	■
	■	■	■		■	■		■
	■	■	■	■	■	■	■	■
	■	■	■	■	■	■		■
	■	■	■	■		■		
	■	■	■		■	■		■
	■	■	■			■		■
	■	■				■		
	■					■		
	■	■				■		
	■	■	■			■		

1) Set the spin speed. Make sure it is suitable for the type of fabric being washed. If you set the No Spin option then only the drain phase is available.

## 6. CONSUMPTION VALUES



Stated values are obtained in laboratory conditions with relevant standards. Different causes can change the data: the quantity and type of laundry and ambient temperature. Water pressure, the supply voltage and the temperature of inlet water may also affect the washing programme duration.







Technical specifications may be changed without prior notice to improve the quality of product.



At the start of the programme, the display shows the programme duration for the maximum load capacity.

During the washing phase the programme duration is automatically calculated and can be greatly reduced if the laundry load is lower than the maximum load capacity (e.g. Cotton 60°C, maximum load capacity 7 kg, the programme duration exceeds 2 hours; actual load 1 kg, the programme duration will be less than 1 hour).

When the appliance is calculating the real programme duration a dot flashes in the display.

Programmes	Load (kg)	Energy consumption (kWh)	Water consumption (litre)	Approximate programme duration (minutes)	Remaining moisture (%) <sup>1)</sup>
Katoen/Coton 60°C	7	1.25	70	146	52
Katoen/Coton 40°C	7	0.78	70	161	52
Synthetica/Synthétiques 40°C	3,5	0.47	50	171	35
Fijne was/Délicats 40°C	3,5	0.53	62	121	35
Wol/Handwas - Laine/Lavage à la main 30°C <sup>2)</sup>	1,5	0.25	45	58	30
<b>Standard cotton programmes</b> 					
Standard 60°C cotton 	7	0.90	49	236	52
Standard 60°C cotton 	3,5	0.67	36	211	52
Standard 40°C cotton 	3,5	0.51	36	205	52

1) At the end of spin phase.

2) Not available for some models.

Off Mode (W)	Left On Mode (W)
0.48	0.48
The information given in the chart above is compliant with the EU Commission regulation 1015/2010 implementing directive 2009/125/EC .	

## 7. OPTIONS

### 7.1 Temperatuur - Température



Set this option to change the default temperature.

Indicator — = cold water.

The display shows the set temperature.

### 7.2 Centrifugeren - Essorage

With this option you can decrease the default spin speed.

The display shows the indicator of the set speed.

**Additional spin options:**  
**No Spin**

- Set this option to remove all spin phases.
- Set it for very delicate fabrics.
- The rinse phase uses more water for some washing programmes.
- The display shows the indicator .

### Rinse Hold

- Set this option to prevent the laundry creases.
- The washing programme stops with the water in the drum. The drum turns regularly to prevent the laundry creases.
- The door stays locked. You must drain the water to unlock the door.
- The display shows the indicator .

 To drain the water refer to 'At the end of the programme'.

### Extra Silent

- Set this option to remove all spin phases and to perform a silent washing.
- The rinse phase uses more water for some washing programmes.
- The washing programme stops with the water in the drum. The drum turns regularly to prevent the laundry creases.
- The door stays locked. You must drain the water to unlock the door.
- The display shows the indicator .

 To drain the water refer to 'At the end of the programme'.

### 7.3 Voorwas - Prélavage

With this option you can add a prewash phase to a washing programme.

Use this option for heavy soil.

When you set this option the programme duration increases.

The related indicator comes on.

### 7.4 Startuitstel - Départ différé



With this option you can delay the start of a programme from 30 minutes to 20 hours.

The display shows the related indicator.

### 7.5 Extra Spoelen - Rinçage Plus

With this option you can add some rinses to a washing programme.

Use this option for persons allergic to detergents and in areas where the water is soft.

The related indicator comes on.

### 7.6 Strijkvrij - Repassage Facile





The appliance carefully washes and spins the laundry to prevent the creases.

The appliance decreases the spin speed, uses more water and adapts the programme duration to the type of laundry.













The related indicator comes on.







### 7.7 Time Manager – +

When you set a washing programme, the display shows the default duration.

Press  or  to decrease or increase the programme duration.

The Time Manager is available only with the programmes in the table.

Indicator				Katoen Eco/Cotton Eco	
	 1)	 1)			
 2)	■	■			■
	■	■	■		■
	■	■			■
	■	■	■	■	■
	■	■			■
	■3)	■3)	■		■3)
	■	■			■

Indicator				Katoen Eco/Cotton Eco	
	 1)	 1)			
 4)	■	■	■3)	■3)	■
					■3)

- 1) If available.
- 2) Shortest: to fresh the laundry.
- 3) Programme default duration.
- 4) Longest: Increasing the programme duration gradually decreases the energy consumption. The optimized heating phase saves energy and the longer duration maintains the same washing results (specially for normal soil).



## 8. SETTINGS

### 8.1 Child Lock

With this option you can prevent that the children play with the control panel.

- To **activate/deactivate** this option, press Voorwas/Prélavage and Strijkvrij/Repassage Facile at the same time until the indicator  comes on/goes off.

You can activate this option:

- After you press : the options and the programme knob are locked.
- Before you press : the appliance cannot start.

### 8.2 Permanent Extra Rinse

With this option you can permanently have an extra rinse when you set a new programme.

- To **activate/deactivate** this option press Startuitstel/Départ différé and Voorwas/Prélavage at the same time until the indicator  comes on/goes off.

### 8.3 Acoustic signals

The acoustic signals operate when:

- The programme is completed.
- The appliance has a malfunction.

To **deactivate/activate** the acoustic signals, press Extra Spoelen/Rinçage Plus and Strijkvrij/Repassage Facile at the same time for 6 seconds.



If you deactivate the acoustic signals, they continue operate when the appliance has a malfunction.

## 9. BEFORE FIRST USE

1. Connect the mains plug to the mains socket.
2. Open the water tap.
3. Put 2 litre of water in the detergent compartment for washing phase.  
This activates the drain system.
4. Put a small quantity of detergent in the compartment for washing phase.

5. Set and start a programme for cotton at the highest temperature without laundry.

This removes all possible dirt from the drum and the tub.

## 10. DAILY USE



**WARNING!**  
Refer to Safety chapters.

### 10.1 Loading the laundry

1. Open the appliance door
2. Shake the items before you put them in the appliance.
3. Put the laundry in the drum, one item at a time.

Make sure not to put too much laundry in the drum.

4. Close the door firmly.

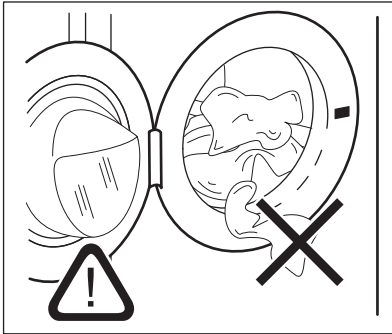

**CAUTION!**  
Make sure that no laundry stays between the seal and the door. There is a risk of water leakage or damage to the laundry.

### 10.3 Detergent compartments



**CAUTION!**  
Use only specified detergents for washing machine.





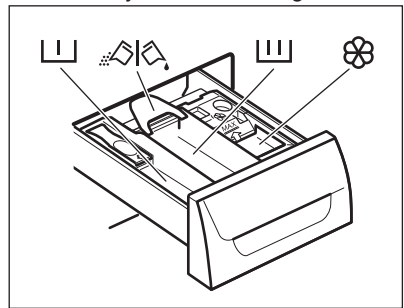

Washing heavily oiled, greasy stains could cause damage rubber parts of the washing machine.

### 10.2 Using detergent and additives

1. Measure out the detergent and the fabric conditioner.
2. Put the detergent and the fabric conditioner into the compartments.
3. Carefully close the detergent drawer



 Always obey the instructions that you find on the packaging of the detergent products.

	Detergent compartment for prewash phase.
	Detergent compartment for washing phase.
	Compartment for liquid additives (fabric conditioner, starch).
	Flap for powder or liquid detergent.

### 10.4 Liquid or powder detergent

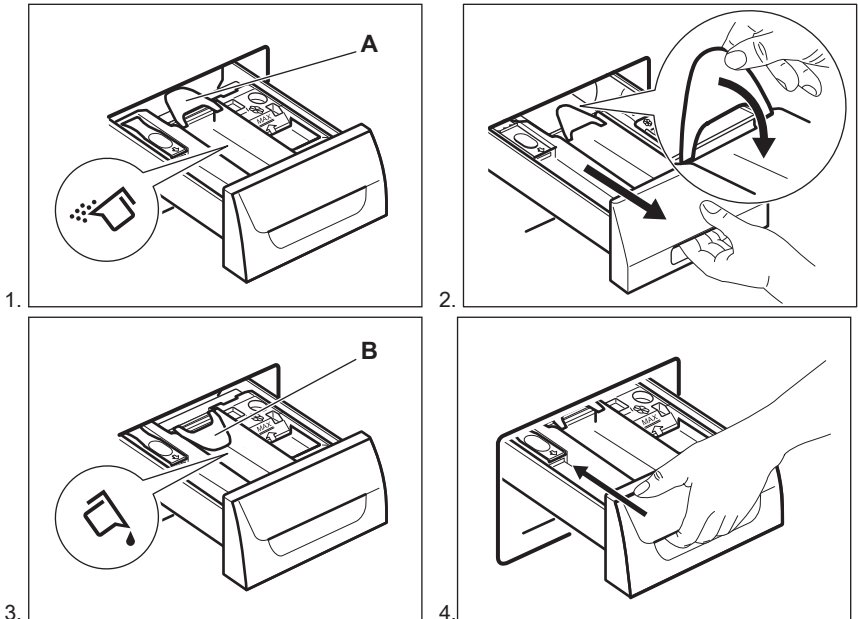

- Position **A** for powder detergent (factory setting).
- Position **B** for liquid detergent.

 **When you use the liquid detergent:**

- Do not use gelatinous or thick liquid detergents.
- Do not put more liquid than the maximum level.
- Do not set the prewash phase.
- Do not set the delay start.





## 10.5 Activating the appliance

Press the  button to activate or deactivate the appliance. A tune sounds when the appliance is activated.



## 10.6 Setting a programme

1. Turn the programme knob and set the programme:
  - The related programme indicator comes on.
  - The indicator of the  flashes.
  - The display shows the level of the Time Manager, the programme duration and the indicators of the programme phases.
2. If necessary, change the temperature, the spin speed, the cycle duration or add available options. When you activate an option, the indicator of the set option comes on.

 If you set something incorrect, the display shows the message .

## 10.7 Starting a programme without the delay start

Press .

- The indicator of  stops to flash and stays on.
- The indicator  starts to flash on the display.
- The programme starts, the door locks, the display shows the indicator .
- The drain pump can operate for a short time when the appliance fills water.



 After approximately 15 minutes from the start of the programme:



- The appliance adjusts automatically the programme duration agree with the laundry load.
- The display shows the new value.





## 10.8 Starting a programme with the delay start

1. Press  again and again until the display shows the delay you want to set.

The related indicator comes on the display.



2. Press :
  - The appliance starts the countdown.
  - The door locks, the display shows the indicator .
  - When the countdown is completed, the programme starts automatically.

 You can cancel or change the set of the delay start before you press the . To cancel the delay start:

- Press  to set the appliance to pause.
- Press  until the display shows .
- Press  again to start the programme immediately.

## 10.9 Interrupting a programme and changing the options

You can change only some options before they operate.

1. Press . The indicator flashes.
2. Change the options.
3. Press  again. The programme continues.

## 10.10 Cancelling a running programme

1. Press the button  for some seconds to cancel the programme and to deactivate the appliance.
2. Press the same button again to activate the appliance. Now, you can set a new washing programme.



Before starting the new programme the appliance could drain the water. In this case, make sure that the detergent is still in the detergent compartment, if not fill the detergent again.

### 10.11 Opening the door when the delay start operates

While the delay start operates, the appliance door is locked and the display shows the indicator

1. Press to pause the appliance. The indicator starts flashing.
2. Wait about 2 minutes until the door lock indicator stops flashing and goes off.
3. Open the door.
4. Close the door.
5. Press again. The indicator appears again on the display.

The delay start continues to operate.

### 10.12 Opening the door when the programme operates

While the programme operates, the appliance door is locked and the display shows the indicator



#### CAUTION!

If the temperature and level of the water in the drum are too high, you cannot open the door.

1. Press the button for some seconds to deactivate the appliance.
2. Wait for some minutes and then open carefully the appliance door.
3. Close the appliance door.
4. Set the programme again.

### 10.13 At the end of the programme

- The appliance stops automatically.
- The acoustic signal operates (if it is activated).

- In the display comes on.
- The indicator of the goes off.
- The door lock indicator flashes for a few minutes, then goes off.
- You can open the door.
- Remove the laundry from the appliance. Make sure that the drum is empty.
- Close the water tap.
- Press the button for some seconds to deactivate the appliance.
- Keep the door ajar, to prevent the mildew and odours.

### The washing programme is completed, but there is water in the drum:

- The drum turns regularly to prevent the creases in the laundry.
- The door lock indicator is on. The door stays locked.
- You must drain the water to open the door.

### To drain the water:

1. Press . The appliance drains the water and spins.
2. To make the appliance drain only, set . If necessary, decrease the spin speed.
3. When the programme is completed, the door lock indicator flashes for a few minutes. When it goes off, you can open the door.
4. Press the button for some seconds to deactivate the appliance.



The appliance drains and spins automatically after approximately 18 hours (except for Wool programme).

### 10.14 AUTO Stand-by option

The AUTO Stand-by function automatically deactivates the appliance to decrease the energy consumption when:

- You do not use the appliance for 5 minutes before you press .

Press the button  to activate the appliance again.

- After 5 minutes from the end of the washing programme

Press the button  to activate the appliance again.

The display shows the end of the last set programme.

Turn the programme knob to set a new cycle.



If you set a programme or an option that ends with water in the drum, the AUTO Stand-by function **doesn't deactivate** the appliance to remind you to drain the water.

## 11. HINTS AND TIPS



### WARNING!

Refer to Safety chapters.

### 11.1 The laundry load

- Divide the laundry in: white, coloured, synthetics, delicates and wool.
- Obey the washing instructions that are on the laundry care labels.
- Do not wash white and coloured items together.
- Some coloured items can discolour with the first wash. We recommend that you wash them separately for the first times.
- Button up pillowcases, close zippers, hooks and poppers. Tie up belts.
- Empty the pockets and unfold the items.
- Turn multilayered fabrics, wool and items with painted illustrations inside out.
- Remove hard stains with a special detergent.
- Wash and pre-treat heavy soil stains before putting items in drum
- Be careful with the curtains. Remove the hooks and put the curtains in a washing bag or pillowcase.
- Do not wash laundry without hems or with cuts. Use a washing bag to wash small and/or delicate items (e.g. underwired bras, belts, tights, etc. ).
- A very small load can cause balance problems with the spin phase. If this occurs, adjust manually the items in the tub and start the spin phase again.

### 11.2 Stubborn stains

For some stains, water and detergent is not sufficient.

We recommend that you pre-treat these stains before you put the items in the appliance.

Special stain removers are available. Use the special stain remover that is applicable to the type of stain and fabric.

### 11.3 Detergents and additives

- Only use detergents and additives specially made for washing machines:
  - powder detergents for all types of fabric,
  - powder detergents for delicate fabrics (40 °C max) and woollens,
  - liquid detergents, preferably for low temperature wash programmes (60 °C max) for all types of fabric, or special for woollens only.
- Do not mix different types of detergents.
- To help the environment, do not use more than the correct quantity of detergent.
- Obey the instructions that you find on the on packaging of these products.
- Use the correct products for the type and colour of the fabric, the programme temperature and the level of soil.
- If your appliance does not have the detergent dispenser with the flap device, add the liquid detergents with a dosing ball (supplied by the detergent's manufacturer).

## 11.4 Ecological hints

- Set a programme without the prewash phase to wash laundry with normal soil.
- Always start a washing programme with the maximum load of laundry allowed.
- If necessary, use a stain remover when you set a programme with a low temperature.
- To use the correct quantity of detergent, check the water hardness of your domestic system. Refer to "Water hardness".

## 12. CARE AND CLEANING



### WARNING!

Refer to Safety chapters.

### 12.1 External cleaning

Clean the appliance with soap and warm water only. Fully dry all the surfaces.



### CAUTION!

Do not use alcohol, solvents or chemical products.

### 12.2 Descaling

If the water hardness in your area is high or moderate, we recommend that you use a water descaling product for washing machines.

Regularly examine the drum to prevent limescale and rust particles.

To remove rust particles use only special products for washing machines. Do this separately from the laundry wash.



Always obey the instructions that you find on the packaging of the product.

## 11.5 Water hardness

If the water hardness in your area is high or moderate, we recommend that you use a water softener for washing machines. In areas where the water hardness is soft it is not necessary to use a water softener.

To know the water hardness in your area, contact your local water authority.

Use the correct quantity of the water softener. Obey the instructions that you find on the packaging of the product.

## 12.3 Maintenance wash

With the low temperature programmes it is possible that some detergent stays in the drum. Perform a maintenance wash regularly. To do this:

- Remove all laundry from the drum.
- Select the cotton programme with the highest temperature with a small quantity of detergent.

## 12.4 Door seal

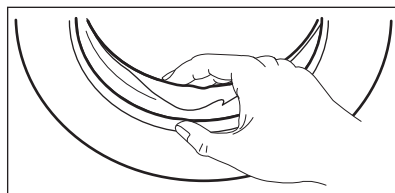

Regularly examine the seal and remove all objects from the inner part.

## 12.5 Cleaning the detergent dispenser

1.

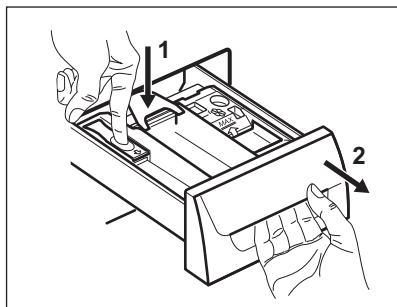

2.

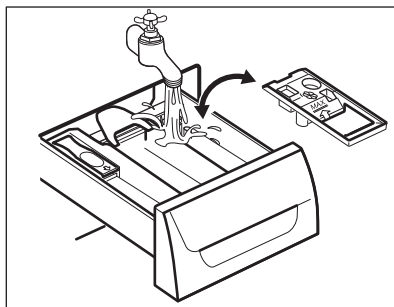

3.

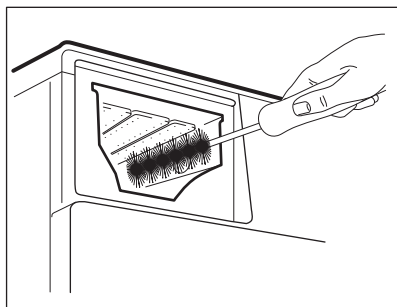

4.

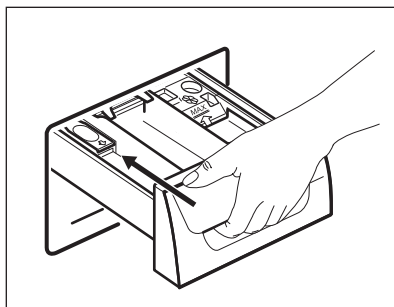

## 12.6 Cleaning the drain filter



Do not clean the drain filter if the water in the appliance is hot.



Regularly check the drain pump filter and make sure that it is clean.



Repeat the steps 2 and 3 until the water stops flowing out.

1.

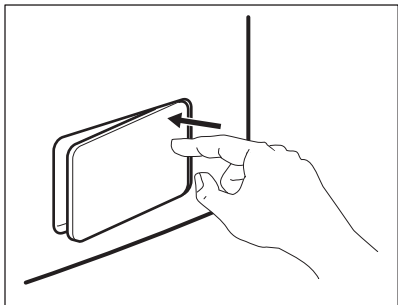

2.

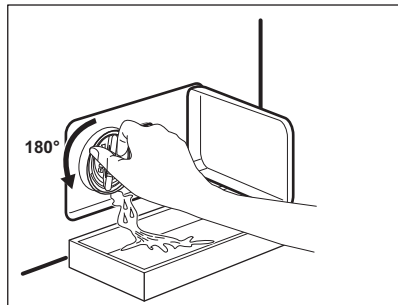

3.

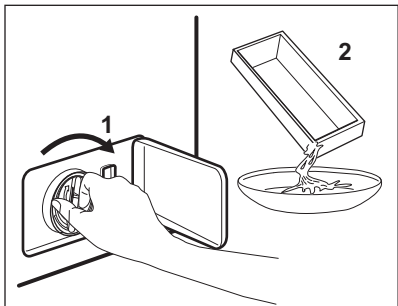

4.

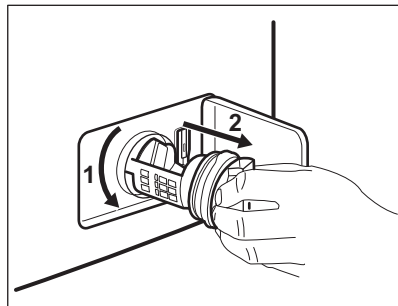

5.

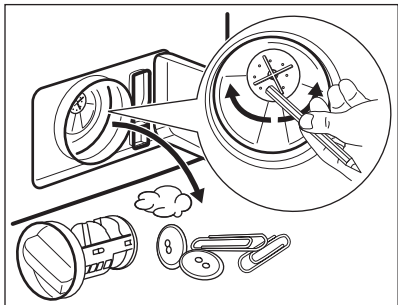

6.

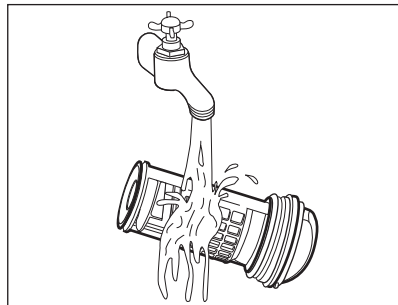

7.

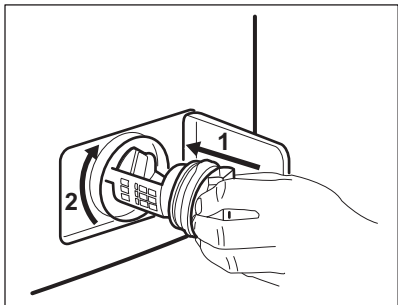

8.

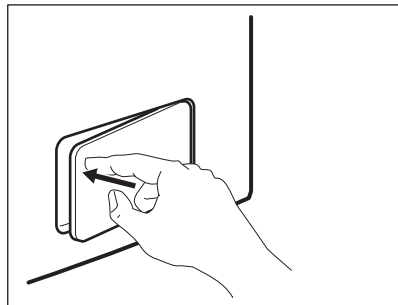

- i** Always keep a rag nearby to dry up any water spillage.

## 12.7 Cleaning the inlet hose and the valve filter

1.

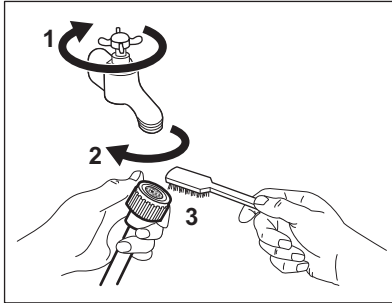

2.

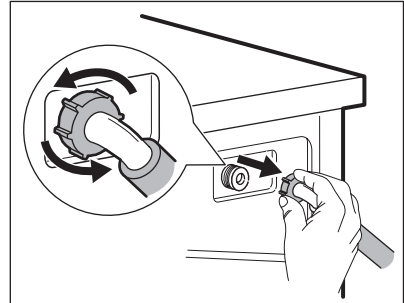

3.

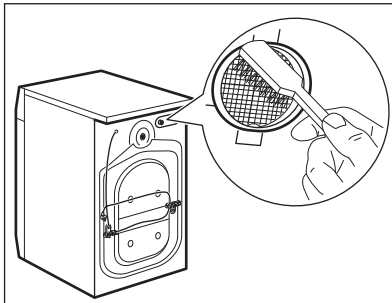

4.

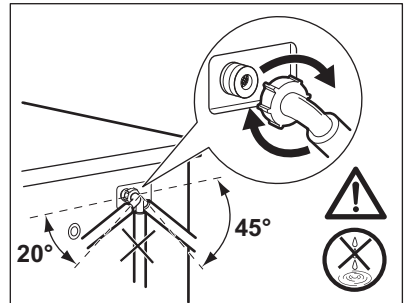

## 12.8 Emergency drain

Because of a malfunction, the appliance cannot drain the water.

If this occurs, do steps (1) through (8) of 'Cleaning the drain filter'. If necessary, clean the pump.

When you drain the water with the emergency drain procedure, you must activate the drain system again:

1. Put 2 litres of water in the main wash compartment of the detergent dispenser.
2. Start the programme to drain the water.

## 12.9 Frost precautions

If the appliance is installed in an area where the temperature can be less than

0° C, remove the remaining water from the inlet hose and the drain pump.

1. Disconnect the mains plug from the mains socket.
2. Close the water tap.
3. Put the two ends of the inlet hose in a container and let the water flow out of the hose.
4. Empty the drain pump. Refer to the emergency drain procedure.
5. When the drain pump is empty, install the inlet hose again.



### WARNING!

Make sure that the temperature is higher than 0 °C before you use the appliance again.

The manufacturer is not responsible for damages caused by low temperatures.

## 13. TROUBLESHOOTING



**WARNING!**  
Refer to Safety chapters.

### 13.1 Introduction

The appliance does not start or it stops during operation.

First try to find a solution to the problem (refer to the table). If the problem persists, contact the Authorised Service Centre.

**With some problems, the acoustic signals operate and the display shows an alarm code:**

- **E10** - The appliance does not fill with water properly.

- **E20** - The appliance does not drain the water.
- **E40** - The appliance door is open or not closed correctly. Please check the door!
- **E40** - The mains supply is unstable. Wait until the mains supply is stable.
- **E9!** - No communication between electronic elements of the appliance. Switch off and switch on again.



**WARNING!**  
Deactivate the appliance before you do the checks.

### 13.2 Possible failures

Problem	Possible solution
The programme does not start.	<ul style="list-style-type: none"> <li>• Make sure that the mains plug is connected to the mains socket.</li> <li>• Make sure that the appliance door is closed.</li> <li>• Make sure that there is not a damaged fuse in the fuse box.</li> <li>• Make sure that the Start/Pause has been pressed.</li> <li>• If the delay start is set, cancel the setting or wait for the end of countdown.</li> <li>• Deactivate the Child Lock function if it is on.</li> </ul>
The appliance does not fill with water properly.	<ul style="list-style-type: none"> <li>• Make sure that the water tap is open.</li> <li>• Make sure that the pressure of the water supply is not too low. For this information, contact your local water authority.</li> <li>• Make sure that the water tap is not clogged.</li> <li>• Make sure that the filter of the inlet hose and the filter of the valve are not clogged. Refer to "Care and cleaning".</li> <li>• Make sure that the inlet hose has no kinks or bends.</li> <li>• Make sure that the connection of the water inlet hose is correct.</li> <li>• Make sure that the connections of the water inlet hoses are correct.</li> </ul>
The appliance does not fill with water and drain immediately.	<ul style="list-style-type: none"> <li>• Make sure that the drain hose is in the correct position. The hose may be too low. Refer to 'Installation instruction'.</li> </ul>



Problem	Possible solution
The appliance does not drain the water.	<ul style="list-style-type: none"> <li>• Make sure that the sink spigot is not clogged.</li> <li>• Make sure that the drain hose has no kinks or bends.</li> <li>• Make sure that the connection of the drain hose is correct.</li> <li>• Set the drain option if you set a programme without drain phase.</li> <li>• Set the drain option if you set an option which ends with water in the drum.</li> <li>• Make sure that the drain filter is not clogged. Clean the filter, if necessary. Refer to 'Care and cleaning'.</li> <li>• If problem remains please contact the Authorised Service Centre.</li> </ul>
The spin phase does not operate or the washing cycle lasts longer than usually.	<ul style="list-style-type: none"> <li>• Set the spin option.</li> <li>• Set the drain option if you set an option which ends with water in the drum.</li> <li>• Make sure that the drain filter is not clogged. Clean the filter, if necessary. Refer to 'Care and cleaning'.</li> <li>• Adjust manually the items in the tub and start the spin phase again. This problem may be caused by balance problems.</li> </ul>
There is water on the floor.	<ul style="list-style-type: none"> <li>• Make sure that the couplings of the water hoses are tight and there is not water leakages.</li> <li>• Make sure that the water inlet hose and the drain hose have no damages.</li> <li>• Make sure you use the correct detergent and the correct quantity of it.</li> </ul>
You cannot open the appliance door.	<ul style="list-style-type: none"> <li>• Make sure that the washing programme is finished.</li> <li>• Set the drain or the spin option if there is water in the drum.</li> <li>• Do the emergency drain procedure. See "Frost precautions" (in "Care and Cleaning" chapter).</li> </ul>
The appliance makes an unusual noise.	<ul style="list-style-type: none"> <li>• Make sure the levelling of the appliance is correct. Refer to 'Installation instruction'.</li> <li>• Make sure that the packaging and/or the transit bolts are removed. Refer to 'Installation instruction'.</li> <li>• Add more laundry in the drum. The load may be too small.</li> </ul>
The cycle is shorter than the time displayed.	<ul style="list-style-type: none"> <li>• The appliance calculates a new time according to the laundry load. See the 'Consumption Values' chapter.</li> </ul>
The cycle is longer than the time displayed.	<ul style="list-style-type: none"> <li>• An unbalanced laundry load increases the duration time. This is a normal behaviour of the appliance.</li> </ul>

Problem	Possible solution
The washing results are not satisfactory.	<ul style="list-style-type: none"> <li>• Increase the detergent quantity or use a different detergent.</li> <li>• Use special products to remove the stubborn stains before you wash the laundry.</li> <li>• Make sure that you set the correct temperature.</li> <li>• Decrease the laundry load.</li> </ul>
You cannot set an option.	<ul style="list-style-type: none"> <li>• Make sure that you press only the wanted touch button(s).</li> </ul>

After the check, activate the appliance. The programme continues from the point of interruption.

If the problem occurs again, contact the Authorised Service Centre.

If the display shows other alarm codes. Deactivate and activate the appliance. If the problem continues, contact the Authorised Service Centre.

## 14. TECHNICAL DATA

Dimension	Width/ Height/ Depth/ Total depth	600 mm/ 850 mm/ 522 mm/ 555 mm
Electrical connection	Voltage Overall power Fuse Frequency	230 V 2200 W 10 A 50 Hz
Level of protection against ingress of solid particles and moisture ensured by the protective cover, except where the low voltage equipment has no protection against moisture		IPX4
Water supply pressure	Minimum Maximum	0,5 bar (0,05 MPa) 8 bar (0,8 MPa)
Water supply <sup>1)</sup>		Cold water
Maximum Load	Cotton	7 kg
Energy Efficiency Class		A+++
Spin Speed	Maximum	1400 rpm

<sup>1)</sup> Connect the water inlet hose to a water tap with a 3/4" thread.

### 14.1 Additional technical data

Brand logo	ELECTROLUX
Name of the distributor	Electrolux Lehel Kft 1142 Budapest Erzsébet kir.né útja 87
Model denomination	EFW 1476 GDW

	Measure unit	
<b>Energy class</b>	(on scale from <b>A</b> to <b>D</b> , where A - most effective and D - least effective)	A+++
<b>Washing performance</b>	(on scale from <b>A</b> to <b>G</b> , where A - higher and G - lower performance)	A
<b>Spin drying performance</b>	(on scale from <b>A</b> to <b>G</b> , where A - better and G - worse)	B
<b>Residual humidity</b>	%	52
<b>Maximum spin speed</b>	rpm	1400
<b>Wash load</b>	kg	7
<b>Average annual energy<sup>1)</sup></b>	kWh	170
<b>Average annual water consumption<sup>1)</sup></b>	litres	9099
<b>Washing noise on normal 60° C cotton programme</b>	dB/A	51
<b>Spinning noise on normal 60° C cotton programme</b>	dB/A	79

<sup>1)</sup> Complies with EN60456.

## 15. ENVIRONMENTAL CONCERNS

Recycle materials with the symbol . Put the packaging in relevant containers to recycle it. Help protect the environment and human health by recycling waste of electrical and electronic appliances. Do not dispose of

appliances marked with the symbol  with the household waste. Return the product to your local recycling facility or contact your municipal office.

[www.electrolux.com/shop](http://www.electrolux.com/shop)



132910271-A-232017

