

## CONTENTS

1. SAFETY INFORMATION.....	3
2. SAFETY INSTRUCTIONS.....	4
3. PRODUCT DESCRIPTION.....	6
4. CONTROL PANEL.....	7
5. BEFORE FIRST USE.....	9
6. DAILY USE.....	9
7. WASHING PROGRAMMES.....	12
8. CONSUMPTION VALUES.....	14
9. HINTS AND TIPS.....	15
10. CARE AND CLEANING.....	16
11. TROUBLESHOOTING.....	18
12. TECHNICAL DATA.....	21
13. INSTALLATION.....	21

## WE'RE THINKING OF YOU

Thank you for purchasing an Electrolux appliance. You've chosen a product that brings with it decades of professional experience and innovation. Ingenious and stylish, it has been designed with you in mind. So whenever you use it, you can be safe in the knowledge that you'll get great results every time.

Welcome to Electrolux.

**Visit our website for:**



Get usage advice, brochures, trouble shooter, service information:  
**[www.electrolux.com/webselfservice](http://www.electrolux.com/webselfservice)**



Register your product for better service:  
**[www.registerelectrolux.com](http://www.registerelectrolux.com)**



Buy Accessories, Consumables and Original spare parts for your appliance:  
**[www.electrolux.com/shop](http://www.electrolux.com/shop)**

## CUSTOMER CARE AND SERVICE

Always use original spare parts.

When contacting our Authorised Service Centre, ensure that you have the following data available: Model, PNC, Serial Number.

The information can be found on the rating plate.

 Warning / Caution-Safety information

 General information and tips

 Environmental information

Subject to change without notice.

# 1. ⚠ SAFETY INFORMATION

Before the installation and use of the appliance, carefully read the supplied instructions. The manufacturer is not responsible for any injuries or damages that are the result of incorrect installation or usage. Always keep the instructions in a safe and accessible location for future reference.

## 1.1 Children and vulnerable people safety

- This appliance can be used by children aged from 8 years and above and persons with reduced physical, sensory or mental capabilities or lack of experience and knowledge if they have been given supervision or instruction concerning the use of the appliance in a safe way and understand the hazards involved.
- Do not let children play with the appliance.
- Children aged 3 years and under must be kept away from this appliance when it is in operation at all times.
- Keep all packaging away from children and dispose of it appropriately.
- Keep detergents away from children.
- Keep children and pets away from the appliance when the door is open.
- Children shall not carry out cleaning and user maintenance of the appliance without supervision.

## 1.2 General Safety

- Do not change the specification of this appliance.
- Do not exceed the maximum load of 3 kg (refer to the "Programme chart" chapter).
- The operating water pressure at the water entry point from the outlet connection must be between 0.5 bar (0.05 MPa) and 8 bar (0.8 MPa).
- The ventilation opening in the base must not be covered by a carpet, mat, or any floor covering.

- The appliance must be connected to the water mains using the new supplied hose sets, or other new hose sets supplied by the Authorised Service Centre.
- Old hose sets must not be reused.
- If the mains power supply cable is damaged, it must be replaced by the manufacturer, its Authorised Service Centre or similarly qualified persons to avoid an electrical hazard.
- Before any maintenance operation, deactivate the appliance and disconnect the mains plug from the socket.
- Do not use high pressure water sprays and/or steam to clean the appliance.
- Clean the appliance with a moist cloth. Use only neutral detergents. Do not use abrasive products, abrasive cleaning pads, solvents or metal objects.

## 2. SAFETY INSTRUCTIONS

### 2.1 Installation

- Remove all the packaging and the transit bolts.
- Keep the transit bolts in a safe place. If the appliance is to be moved in future they must be reattached to lock the drum to prevent internal damage.
- Always take care when moving the appliance as it is heavy. Always use safety gloves and enclosed footwear.
- Do not install or use a damaged appliance.
- Follow the installation instruction supplied with the appliance.
- Do not install or use the appliance where the temperature can be less than 0°C or where it is exposed to the weather.
- The floor area where the appliance is to be installed must be flat, stable, heat resistant and clean.
- Make sure that there is air circulation between the appliance and the floor.
- Do not install the appliance directly over the floor drain.
- Adjust the feet to have the necessary space between the appliance and the flooring.

- Do not install the appliance where the appliance door cannot be fully opened.
- Do not put a container to collect possible water leakage under the appliance. Contact the Authorised Service Centre to ensure which accessories can be used.

### 2.2 Electrical connection

- The appliance must be earthed.
- Always use a correctly installed shockproof socket.
- Make sure that the parameters on the rating plate are compatible with the electrical ratings of the mains power supply.
- Do not use multi-plug adapters and extension cables.
- Make sure not to cause damage to the mains plug and to the mains cable. Should the mains cable need to be replaced, this must be carried out by our Authorised Service Centre.
- Connect the mains plug to the mains socket only at the end of the installation. Make sure that there is

access to the mains plug after the installation.

- Do not touch the mains cable or the mains plug with wet hands.
- Do not pull the mains cable to disconnect the appliance. Always pull the mains plug.
- This appliance complies with the E.E.C. Directives.

## 2.3 Water connection

- Do not cause damage to the water hoses.
- Before connection to new pipes, pipes not used for a long time, where repair work has been carried out or new devices fitted (water meters, etc.), let the water flow until it is clean and clear.
- Ensure that there are no visible water leaks during and after the first use of the appliance.
- Do not use an extension hose if the inlet hose is too short. Contact the service centre for the replacement of the inlet hose.
- You can extend the drain hose to maximum 400 cm. Contact the service centre for the other drain hose and the extension.

## 2.4 Use



### **WARNING!**

Risk of injury, electrical shock, fire, burns or damage to the appliance.

- This appliance is for household use only.

- Follow the safety instructions on the detergent packaging.
- Do not put flammable products or items that are wet with flammable products in, near or on the appliance.
- Make sure that all metal objects are removed from the laundry.
- Do not wash fabrics which are heavily soiled with oil, grease or other greasy substances. It can damage rubber parts of the washing machine. Prewash such fabrics by hand before loading them into the washing machine.
- Do not touch the glass door while a programme is in operation. The glass can get hot.

## 2.5 Service

- To repair the appliance contact an Authorised Service Centre.
- Use original spare parts only.

## 2.6 Disposal



### **WARNING!**

Risk of injury or suffocation.

- Disconnect the appliance from the mains electrical and water supplies.
- Cut off the mains electrical cable close to the appliance and dispose of it.
- Remove the door catch to prevent children or pets from becoming trapped in the drum.
- Dispose of the appliance in accordance with local requirements for the disposal of Waste Electrical and Electronic Equipment (WEEE).

## 3. PRODUCT DESCRIPTION

### 3.1 Machine front

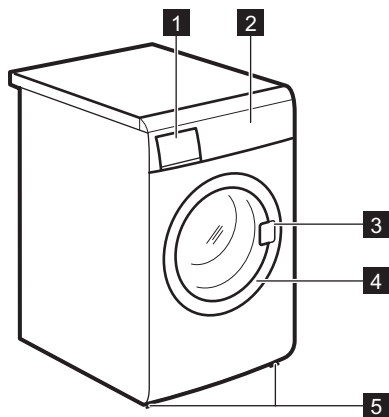

- 1 Detergent dispenser drawer
- 2 Control panel
- 3 Door opening handle
- 4 Outer door frame
- 5 Feet for the appliance level

### 3.2 Machine rear

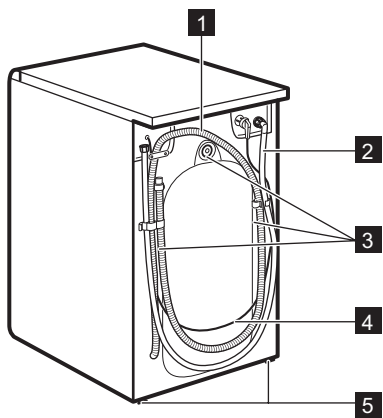

- 1 Drain hose
- 2 Inlet hose
- 3 Transit locking devices
- 4 Electrical lead
- 5 Feet

### 3.3 Detergent dispenser drawer

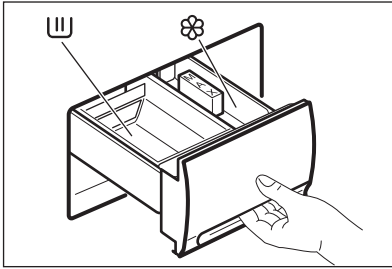

**U** Compartment for powder or liquid detergent used for main wash. If using liquid detergent, pour it **just before** starting the programme.

**i** When you set a programme with pre-wash, put the detergent for prewashing phase directly into the drum.

**Flower symbol** Compartment for liquid additives (fabric softener, starch). Any fabric softener or starching additives must be poured into the compartment before starting the wash programme.

## 4. CONTROL PANEL

### 4.1 Control panel description

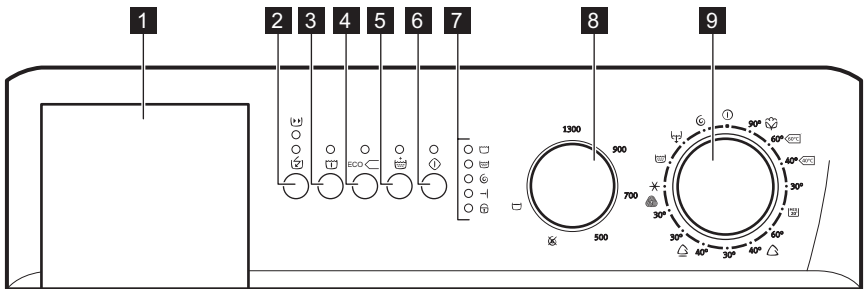

**1** Detergent drawer

**2** QUICK button

**3** PREWASH button

**4** ECO button

**5** EXTRA RINSE button

**6** START/PAUSE button

**7** Programme progress indicators

**8** SPIN reduction selector

**9** Programme selector dial

## 4.2 Detergent drawer

Detergent drawer has 2 separate compartments for detergent and fabric conditioner.

## 4.3 Time Manager

The programme duration can be decreased from 30 to 10 minutes by means of this button.

## 4.4 Prewash

By selecting this option the machine performs a prewash cycle before the main wash phase. The washing time will be prolonged. This option is recommended for heavily soiled laundry.

## 4.5 ECO

You can use this option if you want to wash normally soiled cottons and synthetic laundry and save energy at the same time.

## 4.6 Extra Rinse

This appliance is designed for saving energy. If it necessary to rinse the laundry using an extra quantity of water (extra rinse), select this option. Some additional rinses will be performed. This option is recommended for people who are allergic to detergents, and in areas where the water is very soft.

## 4.7 Start/Pause

This button allows you to start or to interrupt the selected programme.

## 4.8 Indicators

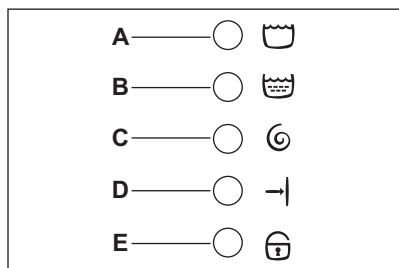

The light **A** illuminates when the machine is performing **the washing phase**.

The light **B** illuminates when the machine is **rinsing**.



The light **C** illuminates when the machine is **spinning**.

The light **D** illuminates at **the end** of the washing cycle.

The light **E** indicates if **the door** can be opened:

- The light is on: the door cannot be opened.
- The light is off: the door can be opened.
- The light is flashing: the door can soon be opened.

## 4.9 Spin Reduction Dial

By turning the spin speed selector you can change the spin speed of the selected programme or to select Rinse Hold  or No Spin  option.

## 4.10 Programme Selector Dial

It allows you to switch the appliance on/off and/or to select a programme.



## 5. BEFORE FIRST USE



### WARNING!

Remove any material from the drum.

Run a wash programme without any load, to clear any residues which may

have been left by the manufacturing process. Pour approx. 100 ml of detergent straight into the drum and run a cotton cycle at 60°C. When the programme is finished the machine will be ready to use.

## 6. DAILY USE



### WARNING!

Refer to Safety chapters.

### 6.1 Loading the laundry

1. Open the appliance door
2. Shake the items before you put them in the appliance.
3. Put the laundry in the drum, one item at a time.

Make sure not to put too much laundry in the drum.

4. Close the door firmly.

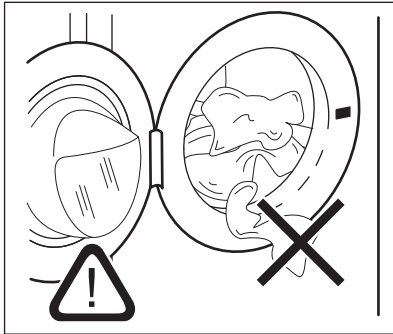

### CAUTION!

Make sure that no laundry stays between the seal and the door. There is a risk of water leakage or damage to the laundry.



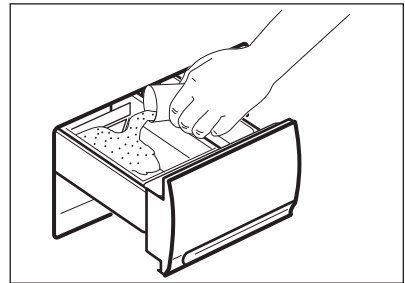

Washing heavily oiled, greasy stains could cause damage rubber parts of the washing machine.

### 6.2 Measure out the detergent and the fabric softener

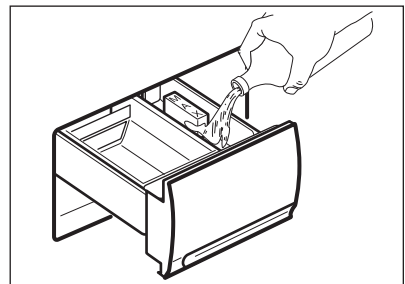

Pull out the dispenser drawer until it stops. Measure out the amount of detergent required, pour it into the larger compartment on the left .



If required, pour fabric softener into the smaller compartment marked  (the amount used must not exceed the «MAX» mark in the drawer). Close the drawer gently.

### 6.3 Select the required programme by means of the programme selector dial

Turn the programme selector dial to the required programme. The selector can be turned either clockwise or anticlockwise.

The green light of button  starts to flash.

The pilot lights corresponding to all phases composing the selected programme are on.

On position  the programme is reset and the machine is switched OFF.

At the end of the programme the selector dial must be turned to position  to switch the machine off.



If you turn the programme selector dial to another programme when the machine is working, the lights in the programme progress display will start to flash to indicate a wrong selection. The machine will not perform the new selected programme.

### 6.4 Select the spin speed, rinse hold or no spin option

Select the spin speed, Rinse Hold option or No Spin option by turning the spin speed selector.

- The position 1300 rpm for Cotton is equivalent to 900 rpm for the Synthetic and Wool programmes and 700 rpm for the Delicate wash programme.

#### Rinse hold

By selecting this option the water of the last rinse is not emptied out to prevent the fabrics from creasing. When the programme has finished, the lights **D** and **E** are lit to indicate that the water must be emptied out (See: 'At the end of the programme').

#### No spin

By selecting this option all the spinning phases are excluded. To be used for extremely delicate material. The machine will add some additional rinses to the cotton and synthetic programmes.

For the maximum spin speed allowed by each programme, refer to the chapter 'Washing programmes'.

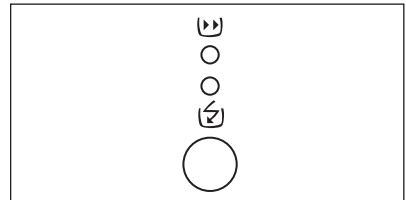

### 6.5 Select the Quick Options

Before you start the programme you can decrease the programme duration. Use this option for items with daily soil. The related indicator comes on.



By selecting Extra Quick  the washing time will be reduced approx. 30 minutes for cotton and by 20 minutes for synthetic. The machine will perform 1 rinse less.

By selecting Quick  the washing time will be reduced approx. 10 minutes. This option is recommended for lightly soiled white-/coloured and synthetic laundry.

- You must select this option after you have set the programme and before you press button .
- You can cancel or modify the Quick or Extra Quick at any moment, before you press button .

### 6.6 Select the desired options

Depending on the programme, different functions can be combined. These must be selected after choosing the desired programme and before pressing the button . The relevant light will illuminate.

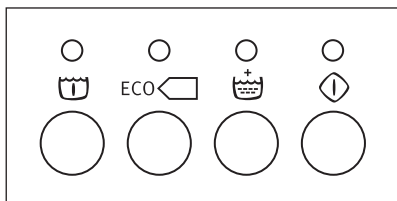

If an incorrect option is selected, the corresponding indicator lamp flashes for about 2 seconds. For the compatibility of the options with the washing programmes, refer to the chapter 'Washing programmes'.

## 6.7 Starting the programme

To start the selected programme, press the button ; the corresponding pilot light stops flashing and remains on.

On programme progress display the pilot lights **A** and **E** illuminate to indicate that the appliance starts operating and the door is locked.

## 6.8 Altering an option or a running programme

It is possible to change any option before the programme carries it out.

Before you make any change, you must pause the washing machine by pressing the button .

The programme can be changed as long as the button has not been pressed. Changing a running programme is possible only by resetting it. Turn the programme selector dial to and then to the new programme position. Start the new programme by pressing the button again.

## 6.9 Interrupting a programme

Press the button to interrupt a programme which is running, the corresponding light starts to flash. Press the button again to restart the programme.

## 6.10 Cancelling a programme

Turn the selector dial to position to cancel a programme which is running. Now you can select a new programme.

## 6.11 Opening the door after the programme has started

First set the machine to pause by pressing the button .

After some minutes, the door can be opened, when the following conditions are observed:

- The water temperature is below 55°C.
- The water level is below the bottom edge of the door.
- The machine doesn't spin.

If you cannot open the door but it is absolutely necessary to open it you have to switch the machine off by turning the selector dial to . After few minutes the door can be opened. (**Pay attention to the water level and temperature!**)

After this procedure, it will be necessary to set the programme and the options again and then press the button .

## 6.12 At the end of the programme

The machine stops automatically.

The pilot light **D** illuminates to indicate that the programme has finished. The pilot light **E** goes out, the door can be opened and the laundry can be removed.

If at the end of a programme there is water in the tub (when option has been selected), **to empty out the water follow the following instructions:**

- turn the programme selector dial to
- select the or programme
- press button





When the pilot light **E** goes out, the door can be opened and the laundry can be removed.





At the end of the cycle, turn the programme selector dial to to switch the machine off.



Remove the laundry from the drum and carefully check that the drum is empty. If you do not intend to carry out another wash, close the water tap.

Leave the door open to prevent the formation of mildew and unpleasant smells.

## 7. WASHING PROGRAMMES

Programme/ Temperature	Type of laundry	Available options	Description of the programme
<b>COTTON</b>  90°C	<b>White cotton</b> (heavily and normally soiled cotton items)	SPIN REDUCTION/NO SPIN/RINSE HOLD EXTRA QUICK/ QUICK 1) PREWASH EXTRA RINSE	Main wash Rinses Long spin max. 1300 rpm Max load 3 kg
<b>COTTON ECO</b>  2) 60°C - 40°C	<b>White cotton eco</b> (This programme can be selected for slightly or normally soiled cotton items. The temperature will decrease and the washing time will be extended. This allows to obtain a good washing efficiency so saving energy.)	SPIN REDUCTION/NO SPIN/RINSE HOLD EXTRA QUICK/ QUICK 1) PREWASH ECO EXTRA RINSE	Main wash Rinses Long spin max. 1300 rpm Max load 3 kg
<b>COTTON</b>  60°C - 30°C	<b>Coloured cotton</b> (normally soiled cotton items)	SPIN REDUCTION/NO SPIN/RINSE HOLD EXTRA QUICK/ QUICK 1) EXTRA RINSE	Main wash Rinses Long spin max. 1300 rpm Max load 3 kg
<b>MIX</b>  20°C	Very energy efficient cold wash programme. Light soil. This programme requires a detergent which is active in cold water.	SPIN REDUCTION/NO SPIN/RINSE HOLD EXTRA RINSE	Main wash Rinses Short spin max. 900 rpm Max Load 1,5 kg

Programme/ Temperature	Type of laundry	Available options	Description of the programme
<b>SYNTHETIC</b>  60°C - 30°C	<b>Synthetic or mixed fabrics:</b> underwear, coloured garments, non-shrink shirts, blouses.	SPIN REDUCTION/NO SPIN/RINSE HOLD EXTRA QUICK/ QUICK <sup>1)</sup> PREWASH ECO EXTRA RINSE	Main wash Rinses Short spin max. 900 rpm Max Load 1,5 kg
<b>DELICATE</b>  40°C - 30°C	<b>Delicate fabrics:</b> acrylics, viscose, polyester.	SPIN REDUCTION/NO SPIN/RINSE HOLD PREWASH EXTRA QUICK/ QUICK <sup>1)</sup> EXTRA RINSE	Main wash Rinses Short spin max. 700 rpm Max Load 1,5 kg
<b>WOOL</b>  30° - COLD ( * )	Washing programme for machine washable wool.	SPIN REDUCTION/NO SPIN/RINSE HOLD	Main wash Rinses Short spin max. 900 rpm Max Load 1 kg
<b>RINSES</b> 	With this programme it is possible to rinse and spin cotton garments which have been washed by hand. The machine performs 3 rinses, followed by a final long spin. The spin speed can be reduced.	SPIN REDUCTION/NO SPIN/RINSE HOLD EXTRA RINSE	Rinses Spin max. 1300 rpm Max Load 3 kg
<b>DRAIN</b> 	For emptying out the water of the last rinse in programmes with the Rinse Hold option selected.		Draining of water Max Load 3 kg

Programme/ Temperature	Type of laundry	Available options	Description of the programme
<b>SPIN</b> 	Separate spin for hand washed garments and after programmes with the Rinse Hold option selected. You can choose the spin speed by turning the spin speed selector to adapt it to the fabrics to be spun.	SPIN REDUCTION	Drain and long spin Max. spin speed 1300 rpm Max Load 3 kg
 /OFF	For resetting the programme or switching the machine off		

1) If you select this option, we recommend that you reduce the maximum load. Recommended load for cotton is 2 kg. This option cannot be selected together with Economy option.

2) **Standard programmes for the Energy Label consumption values.** According to regulation 1061/2010, these programmes are respectively the «Standard 60 °C cotton programme» and the «Standard 40 °C cotton programme». They are the most efficient programmes in terms of combined energy and water consumptions for washing normally soiled cotton laundry.

## 8. CONSUMPTION VALUES







Stated values are obtained in laboratory conditions with relevant standards. Different causes can change the data: the quantity and type of laundry and ambient temperature. Water pressure, the supply voltage and the temperature of inlet water may also affect the washing programme duration.



Technical specifications may be changed without prior notice to improve the quality of product.

Programmes	Load (kg)	Energy consumption (kWh)	Water consumption (litre)	Approximate programme duration (minutes)	Remaining moisture (%) <sup>1)</sup>
Cottons 60°C	3	0,90	45	120	53
Cottons 40°C	3	0,45	45	110	53
Synthetics 40°C	1,5	0,50	50	80	35
Delicates 40°C	1,5	0,50	52	70	35

Programmes	Load (kg)	Energy consumption (kWh)	Water consumption (litre)	Approximate programme duration (minutes)	Remaining moisture (%) <sup>1)</sup>
Wool/Handwash 30°C 2)	1	0,30	60	75	30
<b>Standard cotton programmes</b> 					
Standard 60°C cotton 	3	0,59	42	127	53
Standard 60°C cotton 	1,5	0,54	38	127	53
Standard 40°C cotton 	1,5	0,49	38	137	53

1) At the end of spin phase.

2) Not available for some models.

Off Mode (W)	Left On Mode (W)
0.10	0.98
The information given in the chart above is compliant with the EU Commission regulation 1015/2010 implementing directive 2009/125/EC	

## 9. HINTS AND TIPS

### 9.1 The laundry load

- Divide the laundry in: white, coloured, synthetics, delicates and wool.
- Obey the washing instructions that are on the laundry care labels.
- Do not wash white and coloured items together.
- Some coloured items can discolour with the first wash. We recommend that you wash them separately for the first times.
- Button up pillowcases, close zippers, hooks and poppers. Tie up belts.
- Empty the pockets and unfold the items.
- Turn multilayered fabrics, wool and items with painted illustrations inside out.
- Remove hard stains with a special detergent.
- Wash and pre-treat heavy soil stains before putting items in drum
- Be careful with the curtains. Remove the hooks and put the curtains in a washing bag or pillowcase.
- Do not wash laundry without hems or with cuts. Use a washing bag to wash small and/or delicate items (e.g. underwired bras, belts, tights, etc. ).
- A very small load can cause balance problems with the spin phase. If this occurs, adjust manually the items in the tub and start the spin phase again.

### 9.2 Stubborn stains

For some stains, water and detergent is not sufficient.

We recommend that you pre-treat these stains before you put the items in the appliance.

Special stain removers are available. Use the special stain remover that is applicable to the type of stain and fabric.

### 9.3 Detergents and additives

- Only use detergents and additives specially made for washing machines:
  - powder detergents for all types of fabric,
  - powder detergents for delicate fabrics (40 °C max) and woollens,
  - liquid detergents, preferably for low temperature wash programmes (60 °C max) for all types of fabric, or special for woollens only.
- Do not mix different types of detergents.
- To help the environment, do not use more than the correct quantity of detergent.
- Obey the instructions that you find on the on packaging of these products.
- Use the correct products for the type and colour of the fabric, the programme temperature and the level of soil.
- If your appliance does not have the detergent dispenser with the flap

device, add the liquid detergents with a dosing ball (supplied by the detergent's manufacturer).

### 9.4 Ecological hints

- Set a programme without the prewash phase to wash laundry with normal soil.
- Always start a washing programme with the maximum load of laundry allowed.
- If necessary, use a stain remover when you set a programme with a low temperature.
- To use the correct quantity of detergent, check the water hardness of your domestic system. Refer to "Water hardness".

### 9.5 Water hardness

If the water hardness in your area is high or moderate, we recommend that you use a water softener for washing machines. In areas where the water hardness is soft it is not necessary to use a water softener.

To know the water hardness in your area, contact your local water authority.

Use the correct quantity of the water softener. Obey the instructions that you find on the packaging of the product.

## 10. CARE AND CLEANING



**WARNING!**  
Refer to Safety chapters.

### 10.1 External cleaning

Clean the appliance with soap and warm water only. Fully dry all the surfaces.



**CAUTION!**  
Do not use alcohol, solvents or chemical products.

### 10.2 Descaling

If the water hardness in your area is high or moderate, we recommend that you use a water descaling product for washing machines.

Regularly examine the drum to prevent limescale and rust particles.

To remove rust particles use only special products for washing machines. Do this separately from the laundry wash.



Always obey the instructions that you find on the packaging of the product.

### 10.3 Maintenance wash

With the low temperature programmes it is possible that some detergent stays in the drum. Perform a maintenance wash regularly. To do this:

- Remove all laundry from the drum.



- Select the cotton programme with the highest temperature with a small quantity of detergent.

#### 10.4 Door seal

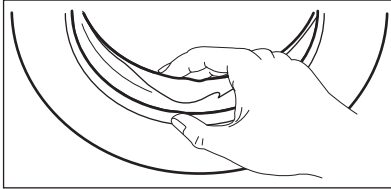

Regularly examine the seal and remove all objects from the inner part.

#### 10.5 Cleaning the dispenser drawer

The washing powder and additive dispenser drawer should be cleaned regularly.

1. If necessary, the whole detergent drawer can be taken out of the machine for cleaning. You need to pull it firmly outwards, so that it comes free of retaining stop.

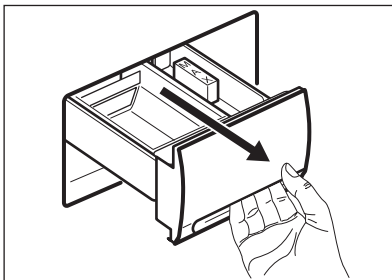

2. To remove the siphon at the inside edge of the drawer for cleaning, you

need to press it inwards and pull it upwards at the same time. Flush it out under a tap, to remove any traces of accumulated powder. When you put it back, press it downwards until you hear a distinct click.

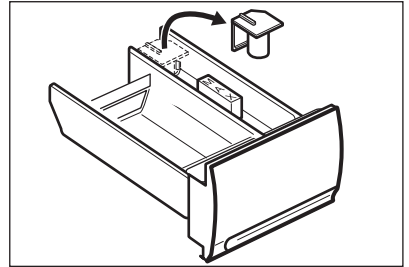

#### 10.6 Cleaning the drawer recess

Having removed the drawer, use a small brush to clean the recess, ensuring that all washing powder residue is removed from the upper and lower part of the recess.

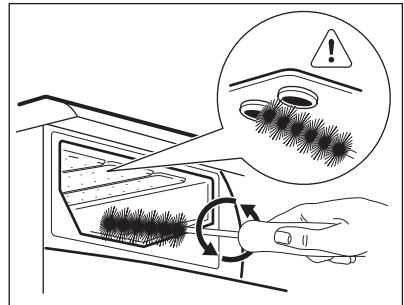

Replace the drawer and run the rinse programme without any clothes in the drum.

## 10.7 Cleaning the inlet hose and the valve filter

1.

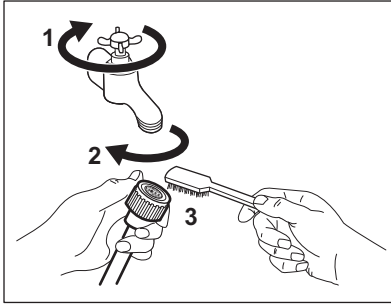

2.

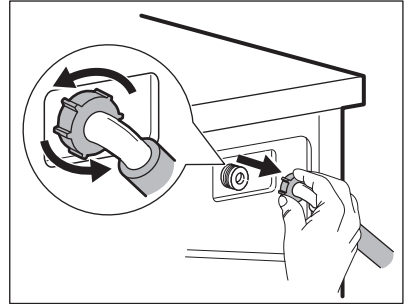

3.

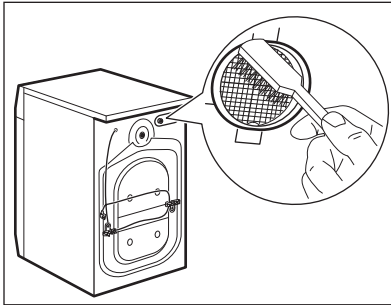

4.

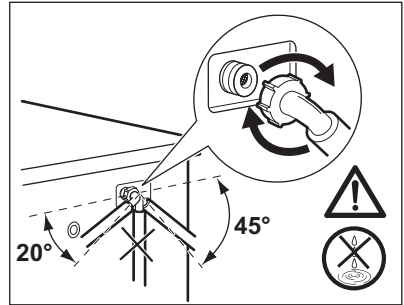

## 10.8 The dangers of freezing

If the machine is exposed to temperatures below 0°C, certain precautions should be taken.

- Turn off the water supply.
- Unscrew the inlet hose from the supply tap.
- Select a wash programme, start the machine and let the programme run for a short time.
- Interrupt the programme by turning the programme selector to ① position.
- Place the end of inlet and drain hoses down low, into the waste gully (floor

drain) set into the floor. Make sure that the end of the hose does not go below the water level in the gully's (drain's) water tap.

- Select the programme "Drain" and let it run until it is finished.
- Turn the programme selector to ① position. When you intend to start the machine up again, make sure that the room temperature is above 0°C.

The appliance is only to be used and stored indoors at normal room temperature. The manufacturer is not responsible for any frost damage.

## 11. TROUBLESHOOTING



**WARNING!**  
Refer to Safety chapters.

### 11.1 Introduction

Certain problems are due to lack of simple maintenance or oversights, which can be solved easily without calling out an engineer. Before contacting your

Authorised Service Centre, please carry out the checks listed below.

During machine operation it is possible that the pilot light **D** blinks to indicate that the machine is not working:

- **1 flash:** problem with the water supply.
- **2 flashes:** problem with the water draining.

- **4 flashes:** door open. Once the problem has been eliminated, press the button  to restart the programme. If after all checks, the problem persists, contact your Authorised Service Centre.

## 11.2 Possible failures

Problem	Possible cause/Solution
<b>The machine does not start:</b>	<p>The door has not been closed.</p> <ul style="list-style-type: none"> <li>• Close the door firmly.</li> </ul> <p>The plug is not properly inserted in the power socket.</p> <ul style="list-style-type: none"> <li>• Insert the plug into the power socket.</li> </ul> <p>There is no power at the socket.</p> <ul style="list-style-type: none"> <li>• Please check your domestic electrical installation.</li> </ul> <p>The main fuse has blown.</p> <ul style="list-style-type: none"> <li>• Replace the fuse.</li> </ul> <p>The selector dial is not correctly positioned and the button Start has not been pressed.</p> <ul style="list-style-type: none"> <li>• Please turn the selector dial and press the button Start again.</li> </ul>
<b>The machine does not fill:</b>	<p>The water tap is closed.</p> <ul style="list-style-type: none"> <li>• Open the water tap.</li> </ul> <p>The inlet hose is squashed or kinked.</p> <ul style="list-style-type: none"> <li>• Check the inlet hose connection.</li> </ul> <p>The filter in the inlet hose is blocked.</p> <ul style="list-style-type: none"> <li>• Clean the water inlet hose filter.</li> </ul> <p>The door is not properly closed.</p> <ul style="list-style-type: none"> <li>• Close the door firmly.</li> </ul>
<b>The machine fills then empties immediately:</b>	<p>The end of the drain hose is too low.</p> <ul style="list-style-type: none"> <li>• Refer to relevant paragraph in «Installation» chapter.</li> </ul>
<b>The machine does not empty and/or does not spin:</b>	<p>The drain hose is squashed or kinked.</p> <ul style="list-style-type: none"> <li>• Check the drain hose connection.</li> </ul> <p>An option or a programme that ends with the water still in the tub or that eliminates all the spinning phases has been selected.</p> <ul style="list-style-type: none"> <li>• Select the draining or spinning programme.</li> </ul> <p>The laundry is not evenly distributed in the drum.</p> <ul style="list-style-type: none"> <li>• Redistribute the laundry.</li> </ul>

Problem	Possible cause/Solution
<b>There is water on the floor:</b>	<p>Too much detergent or unsuitable detergent (creates too much foam) has been used.</p> <ul style="list-style-type: none"> <li>• Reduce the detergent quantity or use another one.</li> </ul> <p>Check whether there are any leaks from one of the inlet hose fittings. It is not always easy to see this as the water runs down the hose; check to see if it is damp.</p> <ul style="list-style-type: none"> <li>• Check the water inlet hose connection.</li> </ul> <p>The drain or inlet hose is damaged.</p> <ul style="list-style-type: none"> <li>• Change it with a new one.</li> </ul>
<b>Unsatisfactory washing results:</b>	<p>Too little detergent or unsuitable detergent has been used.</p> <ul style="list-style-type: none"> <li>• Increase the detergent quantity or use another one.</li> </ul> <p>Stubborn stains have not been treated prior to washing.</p> <ul style="list-style-type: none"> <li>• Use commercial products to treat the stubborn stains.</li> </ul> <p>The correct temperature was not selected.</p> <ul style="list-style-type: none"> <li>• Check if you have selected the correct temperature.</li> </ul> <p>Excessive laundry load.</p> <ul style="list-style-type: none"> <li>• Reduce the laundry load.</li> </ul>
<b>The door will not open:</b>	<p>The programme is still running.</p> <ul style="list-style-type: none"> <li>• Wait the end of washing cycle.</li> </ul> <p>The door lock has not been released.</p> <ul style="list-style-type: none"> <li>• Wait until the indicator light for door locked has gone out.</li> </ul> <p>There is water in the drum.</p> <ul style="list-style-type: none"> <li>• Select drain or spin programme to empty out the water.</li> </ul>
<b>The machine vibrates is noisy:</b>	<p>The transit bolts and packing have not been removed.</p> <ul style="list-style-type: none"> <li>• Check the correct installation of the appliance.</li> </ul> <p>The support feet have not been adjusted</p> <ul style="list-style-type: none"> <li>• Check the correct levelling of the appliance.</li> </ul> <p>The laundry is not evenly distributed in the drum.</p> <ul style="list-style-type: none"> <li>• Redistribute the laundry.</li> </ul> <p>Maybe there is very little laundry in the drum.</p> <ul style="list-style-type: none"> <li>• Load more laundry.</li> </ul>
<b>Spinning starts late or the machine does not spin:</b>	<p>The electronic unbalance detection device has cut in because the laundry is not evenly distributed in the drum. The laundry is redistributed by reverse rotation of the drum. This may happen several times before the unbalance disappears and normal spinning can resume. If, after 10 minutes, the laundry is still not evenly distributed in the drum, the machine will not spin. In this case ,redistribute the load manually and select the spin programme.</p> <ul style="list-style-type: none"> <li>• Redistribute the laundry.</li> </ul> <p>The load is too small.</p> <ul style="list-style-type: none"> <li>• Add more items, redistribute the load manually and then select the spinning programme.</li> </ul>
<b>No water is visible in the drum:</b>	<p>Machines based on modern technology operate very economically using very little water without affecting performance.</p>

After the check, activate the appliance.  
The programme continues from the point  
of interruption.

If the problem occurs again, contact the  
Authorised Service Centre.

## 12. TECHNICAL DATA

Dimension	Width/ Height/ Depth/ Total depth	495 mm/ 670 mm/ 515 mm/ 550 mm
Electrical connection	Voltage Overall power Fuse Frequency	230 V 1600 W 10 A 50 Hz
Level of protection against ingress of solid particles and moisture ensured by the protective cover, except where the low voltage equipment has no protection against moisture		IPX4
Water supply pressure	Minimum Maximum	0,5 bar (0,05 MPa) 8 bar (0,8 MPa)
Water supply <sup>1)</sup>		Cold water
Maximum Load	Cotton	3 kg
Energy Efficiency Class		A
Spin Speed	Maximum	1300 rpm

<sup>1)</sup> Connect the water inlet hose to a water tap with a 3/4" thread.

## 13. INSTALLATION



**WARNING!**  
Refer to Safety chapters.

### 13.1 Lifting the machine

Be careful when lifting the machine.  
Incorrect methods of lifting can cause  
physical injuries and also increase the  
risk of damage to the machine. Open the  
door and take hold of the top inside of  
the door opening. You can also lift the  
machine by gripping the rear overhang of  
the top.

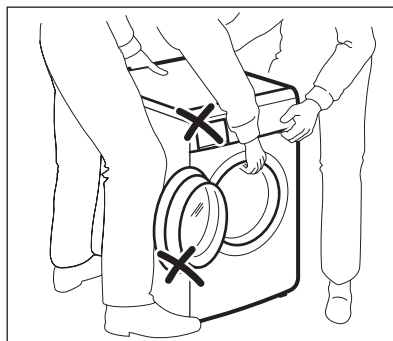

**WARNING!**  
Never lift the machine by  
gripping it's control panel,  
door, or detergent dispenser.

## 13.2 Unpacking

When supplied the washing machine is packed using a number of locking devices/packing pieces to prevent drum and motor from damage in transit. All transit bolts and packing must be removed before using the appliance.

You are advised to keep all transit devices so that they can be refitted if the machine ever has to be transported again.

1. Spread some of the polystyrene packaging materials on the floor behind the machine and then lay the machine carefully rear side down on them. Make sure that no hoses are crushed in the process.

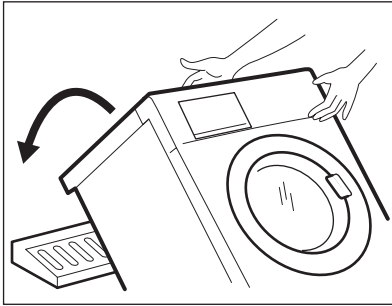

2. Remove the polystyrene base from the bottom of the appliance.

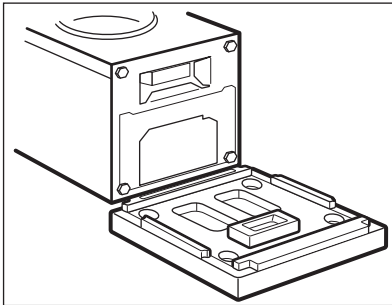

3. Return machine to its upright position and remove the power supply cable and the draining and inlet hose from the hose holders on the rear of the appliance.

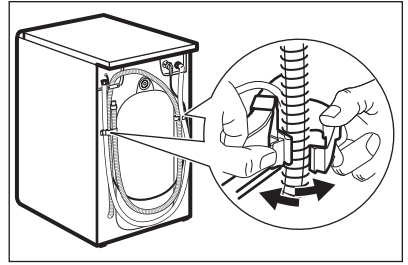

4. With a suitable spanner unscrew and remove the three screws and their spacers on machine's rear.

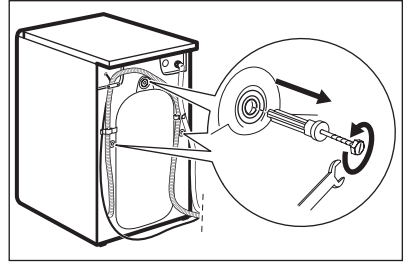

5. The three holes must then be plugged with the plastic plug caps supplied in the bag containing the instruction booklet, which can be found inside the drum.

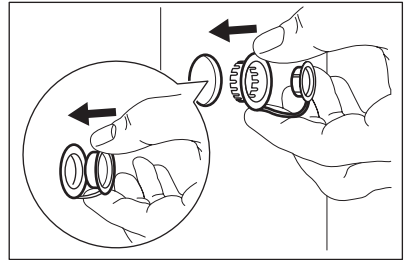

## 13.3 Positioning

Install the machine on a flat hard floor. Make sure that air circulation around the machine is not impeded by carpets, rugs etc. Check that the machine does not touch the wall or furniture. Level the washing machine by raising or lowering the two front feet. If necessary, check the setting with a spirit level. Any necessary adjustment can be made with a spanner. Accurate levelling prevents vibration, noise and displacement of the machine during operation.

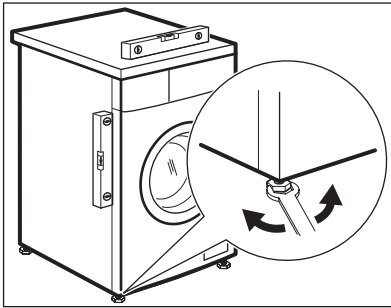
**CAUTION!**

Never place cardboard, wood or similar materials under the machine to compensate for any unevenness in the floor.

**13.4 Water inlet****WARNING!**

**This appliance must be connected to a cold water supply.**

1. Connect the water inlet hose supplied with the machine to a tap with a 3/4" thread. Always use the hose supplied with the appliance.

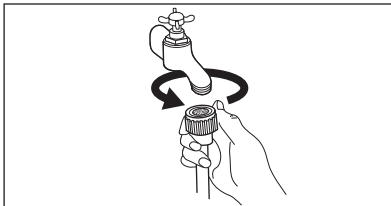

If necessary, use the suitable or supplied restrictor (1/2").

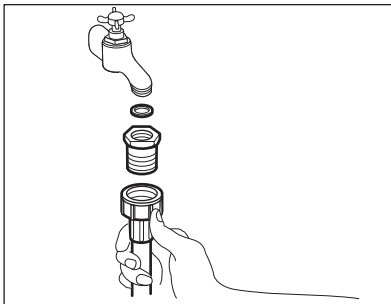

**Do not use the hose from your previous machine to connect to the water supply.**

2. The machine end of the inlet hose can be turned in any direction. Set the hose correctly by loosening the ring nut. After positioning the inlet hose, be sure to tighten the ring nut again to prevent leaks.

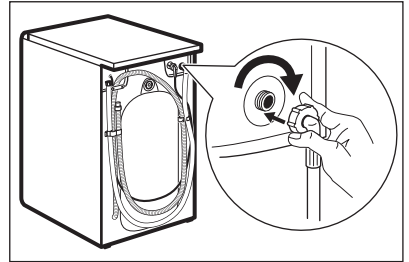

The inlet hose must not be lengthened. If it is too short and you do not wish to move the tap, you will have to purchase a new, longer hose specially designed for this type of use.



Before connecting up the machine to new pipework or to pipework that has not been used for some time, run off a reasonable amount of water to flush out any debris that may have collected in the pipes.

**13.5 Water drainage**

The end of the drain hose can be positioned in three ways:

**Hooked over the edge of a sink using the plastic hose guide supplied with the machine.**

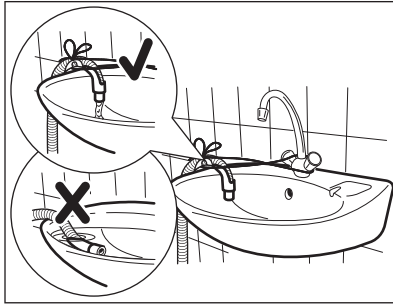

In this case, make sure the end cannot come unhooked when the machine is emptying. This could be done by tying it to the tap with a piece of string or attaching it to the wall.

**In a sink drain pipe with a trap.**

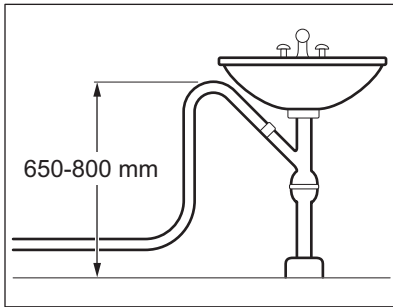

The drain hose can be connected directly into the pipe (e.g. beneath a washtub or sink), above the water trap. The drain hose must be arranged so that some part of it's length is routed up to a level corresponding to the top edge of the tub and fixed in place there.

**Directly into a drain pipe at a height of not less than 65 cm and not more than 80 cm.**

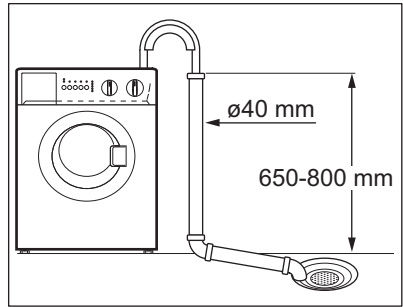

There must be an air gap around and below the end of drain hose. This means that the internal diameter of the standpipe must be larger than the outer diameter of the hose.

The hose must not be stuck into the standpipe more than 50 mm and it has to be fixed in this position. The drain hose must not be kinked.

The drain hose can be extended up to total 3,5 m. For the extension piece use a hose with an internal diameter at least as large as that of the machine's own hose. Use a suitable hose connector.

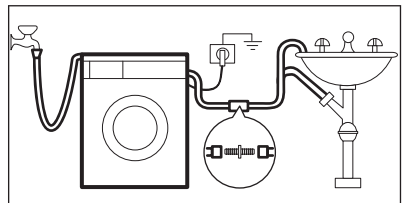

## 14. ENVIRONMENTAL CONCERNS

Recycle the materials with the symbol . Put the packaging in applicable containers to recycle it. Help protect the environment and human health and to recycle waste of electrical and electronic appliances. Do not dispose appliances

marked with the symbol  with the household waste. Return the product to your local recycling facility or contact your municipal office.









[www.electrolux.com/shop](http://www.electrolux.com/shop)



192988423-A-222017

